



THE CITY OF SAN DIEGO

MEMORANDUM

DATE: March 11, 2022

TO: Historical Resources Board and Interested Parties

FROM: Suzanne Segur, Senior Planner, Historical Resources, Development Services Department

SUBJECT: **ITEM 02 – Vulcan Steam Room and Sauna**

The property at 805 West Cedar Street was previously docketed for review by the Historical Resources Board on March 25, 2021, at which time staff recommended designation Under HRB Criterion A as a special element of the City's historical, cultural and social development and its association with the LGBTQ community; and HRB Criterion B for its association with Frank Stiriti. At the hearing, the applicant's consultant requested a 30-day continuance to provide additional information to staff as well as the HRB. The Board approved the continuance and the item was scheduled for the April 22, 2021 hearing.

On April 2, 2021 the applicant submitted a structural report regarding the existing condition of the property. Historical resources staff requested a 30-day continuance at the April HRB hearing for qualified engineering staff to review the report. The Board approved the continuance and the item was scheduled for the May 27, 2021 hearing.

After reviewing the report with qualified engineers, historical resources staff continued to recommend designation of the property under HRB Criterion A and B. Prior to the May 27 2021 hearing the applicant withdrew the item and it was not heard by the Board.

Since May 27, 2021 the applicant has not submitted any new information; however, they have requested that the item be heard by the Board in conjunction with a proposed building modification or demolition of a structure of 45 years or more. Therefore, historical resources staff continues to recommend designation under HRB Criteria A and B.

A handwritten signature in blue ink, appearing to read 'Suzanne Segur', written over a horizontal line.

Suzanne Segur
Senior Planner/ HRB Liaison

SS/ss

Attachments:

1. Staff Report HRB-21-023 dated March 11, 2021 and Draft Resolution
2. Staff Memo dated April 19, 2021
3. Staff Memo dated May 13, 2021
4. Structural Evaluation Report dated May 13, 2020



THE CITY OF SAN DIEGO

Report to the Historical Resources Board

DATE ISSUED: March 11, 2021 REPORT NO. HRB-21-023

HEARING DATE: March 25, 2021

SUBJECT: **ITEM #1 – Vulcan Steam Room and Sauna**

RESOURCE INFO: [California Historical Resources Inventory Database \(CHRID\) link](#)

APPLICANT: I P Investments, LLC; represented by Scott Moomjian

LOCATION: 805 West Cedar Street, Downtown Community, Council District 3
APN 533-321-09-00

DESCRIPTION: Consider the designation of the Vulcan Steam Room and Sauna located at 805 West Cedar Street as a historical resource.

STAFF RECOMMENDATION

Designate the Vulcan Steam Room and Sauna located at 805 West Cedar Street as a historical resource with a period of significance of 1974-1988 under HRB Criteria A and B. The designation excludes the one-story property located at 1560 California Street. This recommendation is based on the following findings:

1. The resource, which is significant for its association with the LGBTQ community, reflects a special element of San Diego's historical, cultural, and social development and retains integrity to its 1974-1988 period of significance. Specifically, the Vulcan Steam Room and Sauna provided a private, safe space for gay men to meet, socialize, and engage in discrete sexual activities at a time when homosexuality was not only condemned, but prior to 1976, illegal. Additionally, the Vulcan Steam Room and Sauna provided emotional support and information to its members regarding sexually transmitted diseases and how best to protect themselves from infection during the height of the HIV/AIDS epidemic when the disease was poorly understood and highly stigmatized.
2. The resource is identified with Frank Stiriti, a historically significant person and retains integrity for his association. Specifically, Frank Stiriti was the owner and founder of the Vulcan Steam Room and Sauna and was also an advocate, educator, and volunteer for the LGBTQ community, especially during the AIDS crisis in San Diego.

BACKGROUND

This item is being brought before the Historical Resources Board in conjunction with a proposed building modification or demolition of a structure of 45 years or more, consistent with [San Diego Municipal Code Section 143.0212](#). The subject resource is located in Downtown San Diego at the beginning of the southside of West Cedar Street adjacent to the Pacific Highway and the County Administration Building.

The property was identified in the [2016 San Diego Citywide LGBTQ Historic Context Statement](#) and for its association with the Lesbian, Gay, Bisexual, Transgender, and Queer (LGBTQ) community's "Social Life" contextual theme.

The property located at 1560 California Street was evaluated by staff and cleared from further historic review through the Potential Historic Resource Review process. The property dates to circa 1907 and was originally constructed as an early 20th century masonry commercial building. Staff found that the property did not rise to the level of individual designation nor warranted further evaluation through a Historical Resources Research Report.

The historic name of the resource, the Vulcan Steam Room and Sauna, has been identified consistent with the Board's adopted naming policy and reflects the name of the tenant that occupied the property during its 39 years of operation.

PRIOR REPORT

In 2019, Scott Moomjian submitted a Historical Resource Research Report for 805 West Cedar Street for staff's review. This report was never deemed complete nor resubmitted with the edits requested by staff, however some of the primary research in the Moomjian report was included in the current Historical Resource Research Report prepared by Brian F. Smith and Associates.

ANALYSIS

A Historical Resource Research Report was prepared by Brian F. Smith and Associates, which concludes that the resource is significant under HRB Criteria A and B and staff concurs. This determination is consistent with the *Guidelines for the Application of Historical Resources Board Designation Criteria*, as follows.

CRITERION A - Exemplifies or reflects special elements of the City's, a community's or a neighborhood's historical, archaeological, cultural, social, economic, political, aesthetic, engineering, landscaping or architectural development.

The subject property located at 805 West Cedar Street, known as the Vulcan Steam Room and Sauna, was one of the seven identified bathhouses within the City of San Diego and was one of the last extant operating bathhouses in the City upon its closure in 2013. As noted in the *2016 San Diego Citywide LGBT Historic Context Statement*, the first documented bathhouse in the City opened in 1869. Bathhouses at this time served as swimming pools for relaxation as well as bathing spots for those without indoor plumbing. The city's earliest bathhouses were located on the waterfront and were seasonal, family-friendly attractions eventually evolving into gay destinations due to their separate men's and women's

facilities. The construction of bathhouses later spread inland and became year-round venues with additional services such as massages, saunas, and other spa features. The gay activities occurring within the bathhouses at this time were secretive with the businesses maintaining heterosexual public fronts and clients, alongside their gay patrons. Bathhouses served as a safe space for many men at this time who resorted to having sex in public and semi-public places out of fear that their landlords or neighbors would discover their true identities, effectively ruining their lives and careers. The construction of bathhouses increased in San Diego with the 1975 passage of California's Consenting Adult Sex Bill, which repealed the law against sodomy and legalized sex between men.

From its inception in July of 1974, the Vulcan Steam Room and Sauna provided a private, safe space during a period of history when physical and romantic relationships between men were not only condemned by society but prior to 1976 were illegal. Frank Stiriti, a gay man as well as the owner and founder of the Vulcan Steam Room and Sauna, aimed to create a recreational facility in conservative San Diego where gay men could find one another. He operated a steady business into the mid-1980s when the AIDS crisis began to emerge throughout the United States. However, he did not close his business like many other local bathhouse owners did during the escalation of the AIDS crisis as requested by San Diego's Board of Supervisors in 1988 to reduce the spread of AIDS. Instead, he used the Vulcan Steam Room and Sauna as a meeting place to engage with community members ways in which to prevent the spread of sexually transmitted diseases, HIV, and AIDS through self-made brochures and advocating for safe sex practices through the distribution of free condoms upon entrance of the building. The brochures were prepared and paid for by Frank Stiriti as there was no government funding for AIDS related literature at this time. The space was later used for seminars on AIDS related resources and quickly became a vital information source for people who did not feel comfortable going to The Center for Social Services (presently The San Diego LGBT Community Center) in Hillcrest.

When considering a potential period of significance for the subject property, staff considered two options. A period of significance which reflected the entire period in which the building operated as a bathhouse would take the period of significance from 1974-2013, which is quite recent and raises questions regarding appropriate historical perspective. When considering that the significance is derived in large part by the Vulcan Steam Room and Sauna serving as a safe, private space for men to meet and engage in discrete sexual activities when it was illegal to do so to providing information on the AIDS crisis when it was highly stigmatized, staff finds that that ending the period of significance when bathhouses in San Diego were requested to close to reduce the spread of AIDS in 1988, which the Vulcan Steam Room and Sauna did not abide by, an appropriate period of time. Therefore, staff has concluded that limiting the period of significance to 1974-1988 for the years that the Vulcan Steam Room and Sauna opened its doors and remained open to provide a safe, private space for men to meet, engage in discrete sexual activities as well as a venue to learn more about the AIDS crisis during a period of time when limited information and resources were available for the highly stigmatized disease.

Significant properties related to the "Social Life" contextual theme within the *2016 San Diego Citywide LGBT Historic Context Statement*, are directly associated with the development of the LGBTQ social scene. The Vulcan Steam Room and Sauna was a significant historical, cultural and social place of interaction for gay men and continues to retain integrity of location, feeling, design, materials, workmanship, and association as related to HRB Criterion A.

Significance Statement: The Vulcan Steam Room and Sauna, located at 805 West Cedar Street, provided a private, safe space for gay men to meet, socialize, and engage in discrete sexual activities at a time when homosexuality was not only condemned, but prior to 1976, illegal. Additionally, the Vulcan Steam Room and Sauna provided emotional support and information to its members regarding sexually transmitted diseases and how best to protect themselves from infection during the height of the HIV/AIDS epidemic when the disease was poorly understood and highly stigmatized. Therefore, staff recommends designation of the resource located at 805 West Cedar Street under HRB Criterion A.

CRITERION B - Is identified with persons or events significant in local, state or national history.

The subject property located at 805 West Cedar Street is significant for its association with Frank Stiriti, the founder and owner of the Vulcan Steam Room and Sauna. Frank Stiriti was born in 1944 in Massachusetts and graduated from Northern University in Boston. He first visited San Diego in 1968 while stationed in the Navy and would later return with his then partner, Joe O'Toole. With the help of his business partner Don Schermerhorn, whom he had met while serving in Vietnam, the Vulcan Steam Room and Sauna opened in 1974. In the beginning one of the three, Stiriti, O'Toole, or Schermerhorn, were present on site. Later, they were able to hire six employees total who were paid an hourly wage as well as insurance and health benefits. With the onset of the AIDS crisis in the early 1980s, Stiriti worked with Jess Jessop, who founded The Center for Social Services in Hillcrest, to provide seminars as well as prepared literature to distribute to patrons about safe sex practices. Stiriti also stepped forward to fund the literature since government funding was not earmarked for addressing these issues at this time.

Along with being a business owner, Stiriti has been a longtime donor to LGBTQ and HIV and AIDS organizations. San Diego City Human Relations Commissioner Nicole Murray-Ramirez noted that Frank Stiriti was directly responsible for the AIDS Assistance Fund's food shelves being stocked during the early days of the AIDS epidemic and was responsible for donating thousands of dollars to the LGBTQ community throughout the Vulcan Steam Room and Sauna's operation. In recent history Stiriti has been acknowledged for his efforts within the LGBTQ community and he was inducted into the Community Wall of Honor located at The San Diego LGBT Community Center as well as the San Diego's LGBT Veteran's Wall of Honor.

Frank Stiriti is a significant individual within San Diego's LGBTQ community and is best associated with his ownership and operation of the Vulcan Steam Room and Sauna within its 1974-1988 period of significance for not only providing a safe space for gay men to be themselves during a period of time when it was illegal to do so, but for utilizing the Vulcan Steam Room and Sauna for lectures and distribution of self-made AIDS related literature during the height of the AIDS crisis, specifically during a time when the disease was poorly understood and highly stigmatized. Therefore, staff finds that the resource continues to retain integrity of location, feeling, design, materials, workmanship, and association as related to HRB Criterion B.

Significance Statement: The subject resource was owned and operated by Frank Stiriti during the its 39 years of operation. Throughout this time, Stiriti provide a safe space for gay men to meet and engage in sexual activities and was an early advocate, educator and donor to San Diego's LGBTQ community, specifically during the AIDS crisis. Therefore, staff recommends designation of the resource located at 805 West Cedar Street under HRB Criterion B.

CRITERION C - Embodies distinctive characteristics of a style, type, period or method of construction or is a valuable example of the use of natural materials or craftsmanship.

The subject property located at 805 West Cedar Street was constructed as an addition to the front façade of the Pioneer Printers building located at 1560 California Street in 1961. In its current condition, the property is a combination of the Block and Utilitarian Industrial architectural styles with the primary elevation of the site featuring an off centered, deeply recessed entrance with evenly spaced, semicircular Doric columns, a smooth stucco finish and two covered window openings. The side and rear elevations feature limited details other than the continuation of the same stucco texture and one Doric column along the east façade.

When the property was first constructed in 1961, it was originally for an addition to the Pioneer Printers located at the rear of the lot. At that time, the building featured a masonry façade with "Pioneer Printers" displayed around the parapet and did not include any window openings along the primary elevation. Modifications since its 1961 construction include the addition of ceramic tile veneer to the northeast corner between 1969 and 1976, the addition of a first-floor window opening on the north façade in 1972, sun deck and patio construction on the east façade between 1974 and 1976, changes to the "805 West Cedar Street" sign, the addition of stucco finish and Doric semicircular columns and window boarding between 1976-2007.

In 2014 the subject property experienced exterior modifications without the benefit of a permit. These modifications occurred on the primary elevation and included the addition of one new window on the second story, two operable windows within the existing boarded window openings, and the removal of a column along the east facing, side elevation. Since these modern modifications were done without the benefit of a permit, they are not considered an impact to the integrity of the building at this time.

While the property does retain its original square footprint and general form, extensive exterior modifications have cumulatively impacted the design, workmanship, and materials which are the significance aspects of integrity related to HRB Criterion C. Therefore, due to substantial alterations and a lack of character defining features of any recognized style, staff does not recommend designation under HRB Criterion C.

CRITERION D - Is representative of a notable work of a master builder, designer, architect, engineer, landscape architect, interior designer, artist or craftsman.

The subject property located at 805 West Cedar Street was built by the C.A. Larsen Construction Company in 1961 as an addition to the Pioneer Printers building located at 1560 California Street. The property which was later separately addressed as 805 West Cedar Street was modified throughout its period of significance by Stanley Brune, Julian V. Thompson, PBD Arch, Max Gurth, Bob Smith, and Guy Irwin. None of these architects or builders have been established by the Historical Resources Board as a Master Architect, Designer or Builder, and there is insufficient information to designate them as such at this time. Therefore, staff does not recommend designation under HRB Criterion D.

CRITERION E - Is listed or has been determined eligible by the National Park Service for listing on the National Register of Historic Places or is listed or has been determined eligible by the State Historical Preservation Office for listing on the State Register of Historical Resources.

The property at 805 West Cedar Street has not been listed on or determined eligible for listing on the State or National Registers. Therefore, the property is not eligible for designation under HRB Criterion E.

CRITERION F - Is a finite group of resources related to one another in a clearly distinguishable way or is a geographically definable area or neighborhood containing improvements which have a special character, historical interest or aesthetic value or which represent one or more architectural periods or styles in the history and development of the City.

The property at 805 West Cedar Street is not located within a designated historic district. Therefore, the property is not eligible for designation under HRB Criterion F.

OTHER CONSIDERATIONS

Designation brings with it the responsibility of maintaining the building in accordance with the Secretary of the Interior's Standards. The benefits of designation include the availability of the Mills Act Program for reduced property tax; the use of the more flexible Historical Building Code; flexibility in the application of other regulatory requirements; the use of the Historical Conditional Use Permit which allows flexibility of use; and other programs which vary depending on the specific site conditions and owner objectives. If the property is designated by the HRB, conditions related to restoration or rehabilitation of the resource may be identified by staff during the Mills Act application process, and included in any future Mills Act contract.

CONCLUSION

Based on the information submitted and staff's field check, it is recommended that the Vulcan Steam Room and Sauna located at 805 West Cedar Street be designated with a period of significance of 1974-1988 under HRB Criteria A as a special element of San Diego's historical, cultural, and social development and Criteria B, for its association with Frank Stiriti, a historically significant individual. The designation excludes the one-story property addressed at 1560 California Street.



Emma Haggerty
Senior Planner
Development Services Department



Suzanne Segur
Senior Planner/ HRB Liaison
Development Services Department

EH/ks/ss

Attachment(s):

1. Draft Resolution
2. Applicant's Historical Report under separate cover

RESOLUTION NUMBER N/A
ADOPTED ON 3/25/2021

WHEREAS, the Historical Resources Board of the City of San Diego held a noticed public hearing on 3/25/2021, to consider the historical designation of the Vulcan Steam Room and Sauna (owned by I P Investments LLC, 908 Southmore Avenue #270, Pasadena, CA 77502) located at **805 West Cedar Street, San Diego, CA 92101**, APN: **533-321-09-00**, further described as LOT 12 R/W in the City of San Diego, County of San Diego, State of California; and

WHEREAS, in arriving at their decision, the Historical Resources Board considered the historical resources report prepared by the applicant, the staff report and recommendation, all other materials submitted prior to and at the public hearing, inspected the subject property and heard public testimony presented at the hearing; and

WHEREAS, the property would be added to the Register of Designated Historical Resources as **Site No. ,** and

WHEREAS, designated historical resources located within the City of San Diego are regulated by the Municipal Code (Chapter 14, Article 3, Division 2) as such any exterior modifications (or interior if any interior is designated) shall be approved by the City, this includes but is not limited to modifications to any windows or doors, removal or replacement of any exterior surfaces (i.e. paint, stucco, wood siding, brick), any alterations to the roof or roofing material, alterations to any exterior ornamentation and any additions or significant changes to the landscape/ site.

NOW, THEREFORE,

BE IT RESOLVED, the Historical Resources Board based its designation of the Vulcan Steam Room and Sauna on the following findings:

(1) The property is historically significant under CRITERION A for its association with the LGBTQ community and reflects a special element of San Diego's historical, cultural, and social development and retains integrity to its 1974-1988 period of significance. Specifically, the Vulcan Steam Room and Sauna provided a private, safe space for gay men to meet, socialize, and engage in discrete sexual activities at a time when homosexuality was not only condemned, but prior to 1976, illegal. Additionally, the Vulcan Steam Room and Sauna provided emotional support and information to its members regarding sexually transmitted diseases and how best to protect themselves from infection during the height of the HIV/AIDS epidemic when the disease was poorly understood and highly stigmatized. This finding is further supported by the staff report, the historical research report, and written and oral evidence presented at the designation hearing.

(2) The property is historically significant under CRITERION B for its association with Frank Stiriti, a historically significant person and retains integrity for his association. Specifically, Frank Stiriti was the owner and founder of the Vulcan Steam Room and Sauna and was also an advocate, educator, and volunteer for the LGBTQ community, especially during the AIDS crisis in San Diego. This finding is further supported by the staff report, the historical research report, and written and oral evidence presented at the designation hearing.

BE IT FURTHER RESOLVED, in light of the foregoing, the Historical Resources Board of the City of San Diego hereby approves the historical designation of the above named property. The designation includes the parcel and exterior of the building as Designated Historical Resource **Site No. .**

BE IT FURTHER RESOLVED, the designation shall exclude the one-story property located at 1560 California Street.

BE IT FURTHER RESOLVED, the Secretary to the Historical Resources Board shall cause this resolution to be recorded in the office of the San Diego County Recorder at no fee, for the benefit of the City of San Diego, and with no documentary tax due.

Vote:

BY: _____
DAVID MCCULLOUGH, Chair
Historical Resources Board

APPROVED: MARA W. ELLIOTT,
CITY ATTORNEY

BY: _____
LINDSEY SEBASTIAN,
Deputy City Attorney



THE CITY OF SAN DIEGO

MEMORANDUM

DATE: April 19, 2021

TO: Historical Resources Board and Interested Parties

FROM: Emma Haggerty, Senior Planner, Historical Resources, Development Services Department

SUBJECT: **ITEM 1 - Vulcan Steam Room and Sauna**

The property at 805 West Cedar Street was previously brought before the Historical Resources Board (HRB) on March 25, 2021. At the hearing, the applicant's consultant requested a 30-day continuance to provide additional information to staff as well as the HRB. The continuance was approved, and the item was docketed for the April 22, 2021 HRB meeting. On April 2, 2021 the applicant's consultant provided additional information in the form of a structural report regarding the existing condition of the property. Historical resources staff are not qualified to review structural reports and the report has been forwarded to DSD's qualified engineering staff to review and provide comment on. Since additional comments from qualified staff have not yet been provided, staff is requesting a continuance so the item may be heard at the May 27, 2021 HRB meeting.

A handwritten signature in blue ink that reads "Emma Haggerty".

Emma Haggerty
Senior Planner



THE CITY OF SAN DIEGO

M E M O R A N D U M

DATE: May 13, 2021

TO: Historical Resources Board and Interested Parties

FROM: Emma Haggerty, Senior Planner, Historical Resources, Development Services Department

SUBJECT: **ITEM 5 - Vulcan Steam Room and Sauna**

The property at 805 West Cedar Street was previously brought before the Historical Resources Board (HRB) and continued from the April 22, 2021 agenda so that qualified staff could review the structural report prepared by Nemaco dated May 13, 2020. DSD's qualified engineering staff have reviewed the applicant's structural report regarding the existing condition of the property and have found that the building, in its current state described in the aforementioned report does not require demolition at this time. Qualified engineering staff has concluded that the deficiencies listed in the report are due to poor maintenance, unpermitted work, and previous code conforming design and construction. Additionally, the reviewer found that the existing CMU walls, foundation and slab were not listed to be deficient due to either poor construction, maintenance, settlement, or cracking and it is assumed that these vital structural components are salvageable and do not need to be replaced.

Historical Resources staff finds that the condition of the property as noted in the structural report does not impact its historical integrity as it relates to HRB Criterion A, for its historical, cultural, and social development or Criterion B, for its association with Frank Stiriti, a historically significant individual. As noted in the [Guidelines for the Application of Historical Resources Board Designation Criteria](#), "...Integrity is not the same as condition. Integrity relates to the presence or absence of historic materials and character defining features. Condition relates to the relative state of physical deterioration of the resource. Integrity is generally more relevant to the significance of a resource than condition. However, if a resource is in such poor condition that original materials and features may no longer be salvageable, then the resource's integrity may be adversely impacted." Staff finds that despite the issues outlined in the structural report, the property continues to retain its integrity of location, setting, feeling, design, materials, workmanship, and association to be eligible for designation under HRB Criteria A and B. Therefore, historical resources staff continues to support the finding that the property is eligible for designation under HRB Criteria A and B.

Emma Haggerty
Senior Planner



Cycle Issues

THE CITY OF SAN DIEGO
Development Services Department
1222 1st Avenue, San Diego, CA 92101-4154

L64A-003A

Project Information

Project Nbr: 673269 **Title:** Digital 805 Demolition
Project Mgr: *System Managed, Project (619) 446-5000 DSDProjectInfo@sandiego.gr



Review Information

Cycle Type: 13 BDR-Structural (Appmt.)	Submitted: Deemed Complete on 04/27/2021
Reviewing Discipline: BDR-Structural	Cycle Distributed:
Reviewer: Lepper, Stephen (619) 446-5081 Slepper@sandiego.gov	Assigned: 04/27/2021 Started: 04/27/2021 Review Due: 05/05/2021
Hours of Review: 0.00	Completed: 04/27/2021 COMPLETED ON TIME
Next Review Method: BDR-Structural (Appmt.)	Closed: 04/27/2021

. Last month BDR-Structural performed 1787 reviews, 55.6% were on-time, and 78.2% were on projects at less than < 3 complete submittals.

Structural report evaluation r

<u>Cleared?</u>	<u>Issue Num</u>	<u>Issue Text</u>
<input checked="" type="checkbox"/>	1	Per the report provided by Nemaco, Dated: May 13, 2020, the existing building located at 805 W. Cedar Street requires corrective action to become habitable. It is in my opinion that the deficiencies listed in the report are due to poor maintenance, unpermitted work and previous code conforming design and construction. And since the existing CMU walls, foundation and slab were not listed to be deficient due to either poor construction, maintenance, settlement or cracking it is assumed that these vital structural component area salvageable. (From Cycle 12)
<input checked="" type="checkbox"/>	2	This building, in its current state described by the aforementioned report, does not require demolition at this time. (From Cycle 12)



**STRUCTURAL EVALUATION REPORT
FOR BUILDING LOCATED AT:**

**For 805 W. Cedar Street
San Diego, CA. 92101**

Prepared By:



Date: May 13, 2020

Table of Content

- I. Summary**
- II. Introduction**
- III. Evaluation**
- IV. Compliance with Municipal Code**
- V. Compliance with California Codes**
- VI. Summary of Findings**

APPENDIX A. Images of Structural Deficiencies

APPENDIX B. Structural Calculations

APPENDIX C. Site Plan

APPENDIX D. As-Built Plans

APPENDIX E. Supplemental Photos

I. Summary

This Structural Building Evaluation has been conducted for a commercial building located at 805 W. Cedar Street, San Diego, CA 92101. The building has been evaluated as a two story Concrete Bearing Wall Structure with flexible diaphragm

This Structural Building Evaluation was performed in accordance with the provisions of San Diego Municipal Code Sections 121.0403, 121.0406, California Health and Safety Section 17920.3, California Building Code and the State Historical Building Code. These provisions are the current standards for evaluating an existing building. These standards provide direction for the evaluation of the abatement of dangerous and/or substandard structures.

The evaluation was performed in order to determine the most appropriate course of action to abate the dangerous and unsafe conditions observed. Based on our site observation of the building and its structural elements, we found significant deficiencies throughout the vertical and horizontal structural supports. Furthermore, the building lacks the ability to withstand lateral loads in the event of a seismic activity. Based on the criteria of the San Diego Municipal Code, the building in the current state, meets the substandard, and dangerous building criteria. Based on the criteria of the California Building Code and the State Historical Building Code, the building is unsafe.

In conclusion, significant structural and building deficiencies were identified, and therefore, it is beyond repair and the demolition is the only feasible option. These deficiencies pose significant danger to life safety.

II. Introduction

Overview

The objective of this evaluation is to determine the current state of the building structure located at 805 W. Cedar Street, San Diego, CA 92101. Based on our site inspection, visual observation and professional experience, it is quite evident that the structure is in complete disrepair and cannot support vertical or horizontal loads or resist the potential lateral loads applied to it. The existing two story building is constructed of CMU walls with wood framing for the floor system made up of 2x16's spanning up to 25 ft. The roof framing is made up 2x12's spanning up to 25 ft. *See Appendix D.*

For a descriptive evaluation of the existing structure and its deficiencies refer to the section titled "Evaluation" below.

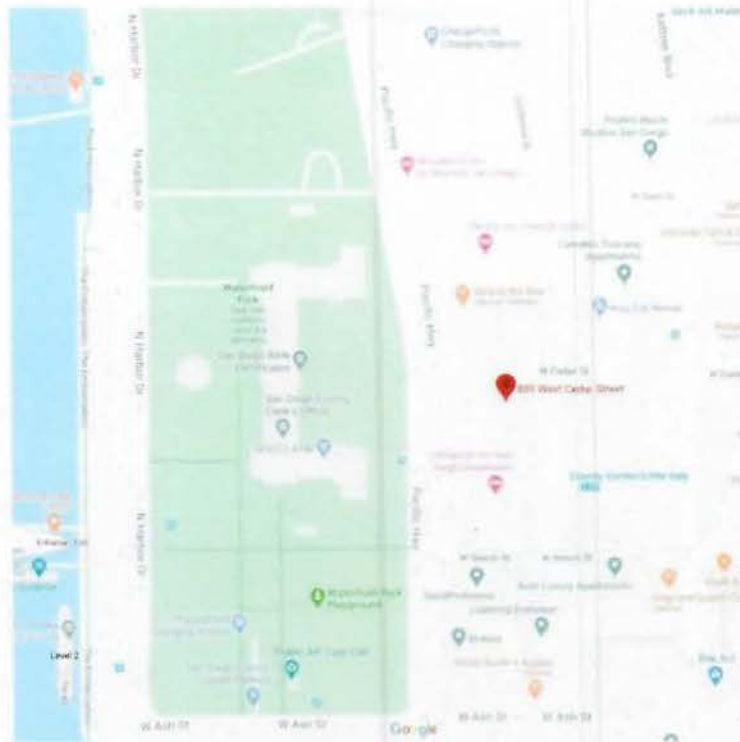

Vicinity Map

Methodology

The building assessment was performed in accordance with the California Building Code, California Historical Building Code, the San Diego Municipal Code and the California Health and Safety Code, more specifically:

- California Building Code 2019 Chapters 16, 16A, 23, and ASCE 7-16 Minimum Design Loads and Associated Criteria for Building and Other Structures.
- State Historical Building Code (SHBC) under Sections 18950 thru 18961 of Division 13, Part 2.7 of the Health and Safety Code.
- California Health and Safety Code, Section 17920.3
- San Diego Municipal Code, Chapter 12, Article 1, Division 4: Procedures for Abatement of Dangerous, or Substandard Structure.

Scope of Work

The scope of this structural evaluation includes the following:

General Evaluation: Document review and site evaluation; determine expected level of performance, seismicity, and current elevation condition.

Summary of findings: provide a list indicating any deficiencies discovered during the evaluation assessment. Recommendation for corrective action is provided for the deficiencies observed.

III. Evaluation

Site inspection was conducted to review and observe current conditions, and assess the existing structural condition, refer to the attached images under *Appendix A*.

For the lateral resisting system of the building all the exterior walls are concrete with a flexible diaphragm for the roof system. The roof diaphragm should tie back to the top of the concrete walls to create out of plane stability to the walls. Due to heavy weight of the concrete walls, the roof diaphragm should be designed as a high-strength diaphragm to support top of all concrete walls and prevent any out of plane instability in seismic events. Currently there is no tie back connection between the existing roof trusses and the walls in both parallel or perpendicular conditions to concrete walls. See *Appendix A, Images #1, #2*.

The existing roof framing system is a flexible diaphragm which is supported at the middle with a concrete beam, which usually is required to be braced with the diaphragm at the compression side. The existing flexible diaphragm will not provide the fully braced concrete beam. Part of the roof framing is deteriorated due to water damage. The floor framing is composed of 2x members which are supported at the center of the building with either a steel beam or wood beam. The wood beam is under supported with a double 2x4 posts for the 16 ft span beam. This is under designed, please see the attached calculation under *Appendix B*. Also, there is a portion of the floor framing in the center of the building which does not have any support and the joists are spliced creating an unsafe condition that will result in the floor system failure when live loads are applied to it. See *Appendix A Images #3, #4, #5 and #6*.

IV. Compliance with Municipal Code

San Diego Municipal Code Section 121.0403 Criteria for Determining That a Structure Is Dangerous

(b) There is a significant risk of collapse, detachment, or dislodgement of any portion, member, appurtenance, or ornamentation of the structure under service loads.

The existing structure meets this requirement because there is significant risk of collapse, detachment, or dislodgement of any portion, member of the structure under the service loads. The existing roof and floor framing including the CMU walls are unstable under the seismic lateral force. This includes potential failure of the floor framing from gravity loads due to free standing CMU walls without any tie back. There is also a lack of support at portions of the floor and the areas of the floor that are supported are done so with under designed columns.

San Diego Municipal Code Section 121.0404 Criteria for Determining That a Structure Is unsafe

(a) The walking surface of any aisle, passageway, stairway, or other means of exit is so warped, worn, loose, torn, or otherwise unsafe that it does not provide a safe and adequate means of exit in case of fire or panic;

There is one stair case inside the building which is poorly constructed and damaged and unsafe to serve as a portion of the means of egress. The construction of the staircase is inadequate to support the live loads applied to the structure.

(b) Any portion, member, or appurtenance of the structure has been damaged by fire, earthquake, wind, flood, or by any other cause to such an extent that it is likely to partially or completely collapse, fail, detach, or dislodge;

The exterior CMU wall may collapse/detach in out of plane direction due to seismic event since there is no tie back connection to the walls.

(c) Any portion of the structure is likely to partially or completely collapse because of dilapidation, deterioration, or decay; faulty construction; the removal, movement, or instability of any portion of the ground necessary to support the building; the deterioration, decay, or inadequacy of its foundation; or any other cause;

The current floor framing system is a faulty construction with not the adequate support in some areas which may cause a collapse. Deterioration of some floor members have occurred due to extensive water damage. This damage occurs close to the bearing walls where floor members are most likely to shear and cause the floor system to collapse.

(k) The existing use or occupancy violates the California Health and Safety Code or Building, Electrical, Plumbing, Mechanical or Residential Building Regulations of the Municipal Code.

The conditions observed and stated in this report do not comply with the model building, electrical, plumbing and mechanical codes. These conditions are enumerated in the following section of the report.

V. Compliance with California Code

California Health and Safety Code – HSC Chapter 2 Rules and Regulation Section 17920.3

Any building or portion endangers the life, limb, health, property, safety, or welfare of the public or the occupants thereof shall be deemed and hereby is declared to be a substandard building.

(b) Structural hazards shall include, but not be limited to, the following:

(2) Defective or deteriorated flooring or floor supports.

The flooring at some areas is defected due to water damage and faulty construction. See Appendix A, Images #4, #7.

(3) Flooring or floor supports of insufficient size to carry imposed loads with safety.

The portion of the floor system is unsupported or supported with under designed columns.

(5) Members of walls, partitions, or other vertical supports that are of insufficient size to carry imposed loads with safety.

Portions of the floor system are supported with under designed columns sizes. Additionally, portions of the floor system are not supported at all and the joists do not span from one bearing wall/member to another. These joists are lapped and spliced in locations that require a bearing element below them.

(6) Members of ceilings, roofs, ceiling and roof supports, or other horizontal members which sag, split, or buckle due to defective material or deterioration.

The portions of roof and floor system sag, split and bucked due to deterioration and defective material

(o) Inadequate structural resistance to horizontal forces

The existing structure meets this requirement. Inadequate structural resistance to horizontal forces, because the heavy CMU walls are not tie back to the roof diaphragm and roof diaphragm is not constructed to capture out of plane loads from the concrete walls.

California Health and Safety Code – HSC Division 13 Part 2.7 State Historical Building Code 18957

Nothing in this part shall be construed to prevent authorized building or fire officials from the performance of their duties when in the process of protecting the public health, safety, and welfare.

The existing building structure is so damaged and incapable of meeting the minimum requirement to support vertical and horizontal loads in accordance with the model codes that it is beyond repair and demolition is the only feasible option.

VI. Summary of Findings

1. Based upon the previously referenced criteria of the Municipal Code, the California Building Code, the California Historic Building Code and Health and Safety Code, the existing "805 W. Cedar Street, San Diego, CA 92101" building structure is so dangerous, substandard, and inadequate that it requires immediate demolition. The existing building is a major risk to life safety and meets criterion for a structure that is dangerous and unsafe and it is not repairable.
2. The existing lateral and gravity resisting system displays conditions of a weak and unsafe condition. The lateral resisting system are in condition whereas the strength and stiffness of the lateral force resisting system in any story is less than 75 percent of the value required for similar new construction in accordance with the building code.

In conclusion, the building structure is so damaged and insufficient to support the basic criteria for design loads set forth by the governing building codes that it presents a great risk of complete failure and potential threat to life safety. The building is beyond repair and demolition is the only feasible option.

Thank you for the opportunity to provide our professional services.

Please contact me if you have any questions

NEMACO PLANNING ENGINEERING & CONSTRUCTION

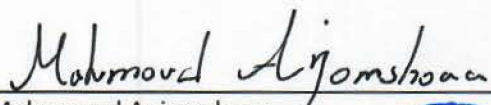
Mahmoud Anjomshoaa
R.C.E 36073
Structural Engineer



Nemat Anjomshoaa
President of Nemaco

**APPENDIX A – IMAGES OF
STRUCTURAL DEFICENCIES**

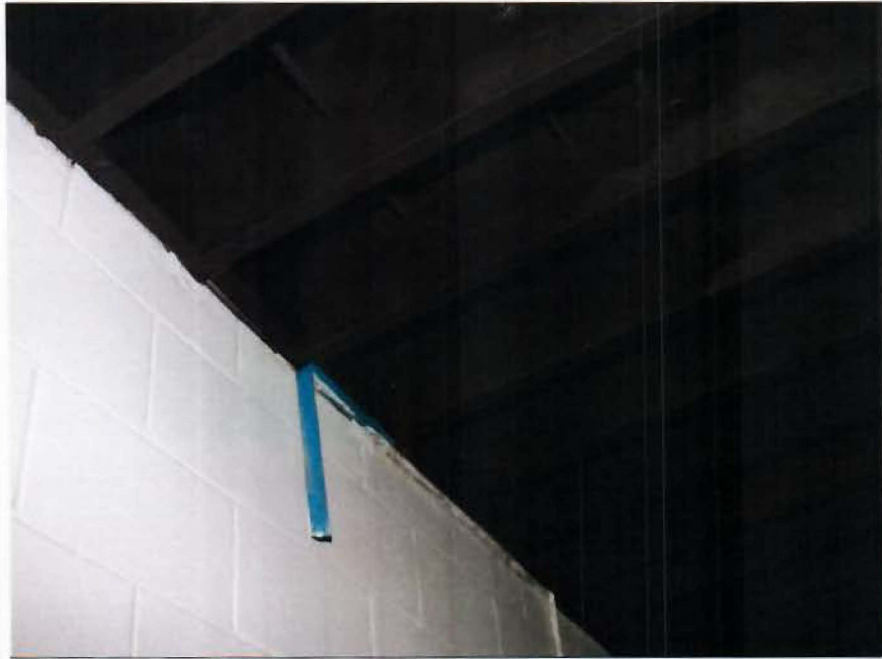

Image #1 shows the joist perpendicular to CMU wall
Without any tie connection to two story CMU wall



Image #2 shows the joist parallel to CMU wall
Without any tie connection to two story CMU wall



Image #3 shows the floor joist supported with wood beam which support with 2-2x6 stud



Images #4 shows the concrete beam support the flexible diaphragm and deterioration of the roof framing



Image #5 show the portion of the floor with out any support at the middle with spliced joist



Image #6 shows the stairs case with splice at the stringer and deteriorated wood

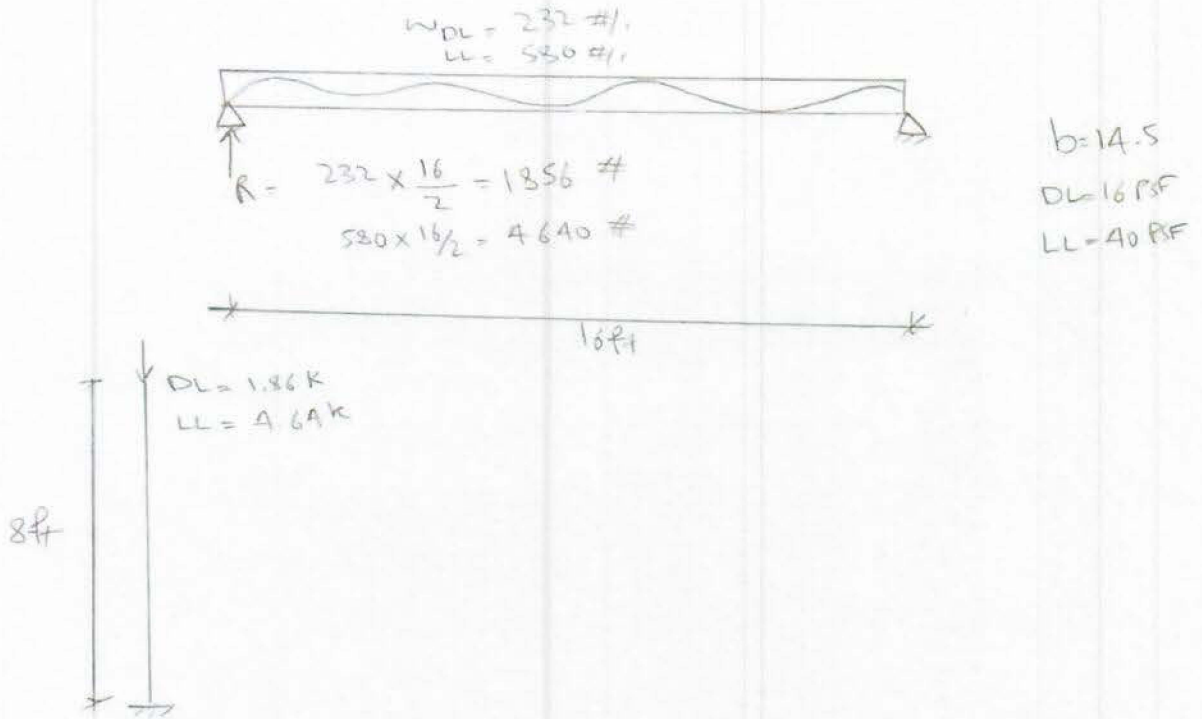

Image #7 shows the roof framing deteriorated wood as well as notched joist

***APPENDIX B - STRUCTURAL
CALCULATIONS***

805 W. CEDAR STREET
SAN DIEGO, CA 92101

(E) 2-2x4 COL



Title Block Line 1
 You can change this area
 using the "Settings" menu item
 and then using the "Printing &
 Title Block" selection.
 Title Block Line 6

Project Title:
 Engineer:
 Project ID:
 Project Descr:

Printed: 6 MAY 2020, 3:25PM

File: California St.ec6

Software copyright ENERCALC, INC. 1983-2020, Build:12.20.2.28

RA STRUCTURAL ENGINEERING

Wood Column

Lic. #: KW-06005737

DESCRIPTION: (E) 2-2x6

Code References

Calculations per NDS 2018, IBC 2018, CBC 2019, ASCE 7-16

Load Combinations Used : ASCE 7-16

General Information

Analysis Method :	Allowable Stress Design			Wood Section Name	2-2x6	
End Fixities	Top & Bottom Pinned			Wood Grading/Manuf.	Graded Lumber	
Overall Column Height	8 ft			Wood Member Type	Sawn	
<i>(Used for non-slender calculations)</i>						
Wood Species	Douglas Fir - Larch			Exact Width	3.0 in	
Wood Grade	No.2			Exact Depth	5.50 in	
Fb +	875.0 psi	Fv	170.0 psi	Area	16.50 in ²	
Fb -	875.0 psi	Ft	425.0 psi	Ix	41.594 in ⁴	
Fc - Prll	600.0 psi	Density	31.210 pcf	Iy	12.375 in ⁴	
Fc - Perp	625.0 psi					
E : Modulus of Elasticity . . .	x-x Bending	y-y Bending	Axial		Allow Stress Modification Factors	
	Basic	1,300.0	1,300.0	1,300.0 ksi	Cf or Cv for Bending	1.30
	Minimum	470.0	470.0		Cf or Cv for Compression	1.10
					Cf or Cv for Tension	1.30
					Cm : Wet Use Factor	1.0
					Ct : Temperature Factor	1.0
					Cfu : Flat Use Factor	1.0
					Kf : Built-up columns	1.0 NDS 15.3.2
					Use Cr : Repetitive ?	No

Brace condition for deflection (buckling) along columns :

X-X (width) axis : Unbraced Length for buckling ABOUT Y-Y Axis = 8 ft, K = 1.0

Y-Y (depth) axis : Unbraced Length for buckling ABOUT X-X Axis = 8 ft, K = 1.0

Applied Loads

Service loads entered. Load Factors will be applied for calculations.

Column self weight included : 28.609 lbs * Dead Load Factor

AXIAL LOADS . . .

Axial Load at 8.0 ft, D = 1.860, L = 4.640 k

DESIGN SUMMARY

Bending & Shear Check Results

FAIL Max. Axial+Bending Stress Ratio =	1.244 : 1
Load Combination	+D+L+H
Governing NDS Formula	Comp Only, fc/Fc'
Location of max. above base	0.0 ft
At maximum location values are . . .	
Applied Axial	6.529 k
Applied Mx	0.0 k-ft
Applied My	0.0 k-ft
Fc : Allowable	318.096 psi

Maximum SERVICE Lateral Load Reactions . .	
Top along Y-Y	0.0 k
Bottom along Y-Y	0.0 k
Top along X-X	0.0 k
Bottom along X-X	0.0 k

Maximum SERVICE Load Lateral Deflections . . .				
Along Y-Y	0.0 in	at	0.0 ft	above base
for load combination :	n/a			
Along X-X	0.0 in	at	0.0 ft	above base
for load combination :	n/a			

Other Factors used to calculate allowable stresses . . .

Bending	Compression	Tension
---------	-------------	---------

PASS Maximum Shear Stress Ratio =	0.0 : 1
Load Combination	+0.60D+0.70E+H
Location of max. above base	8.0 ft
Applied Design Shear	0.0 psi
Allowable Shear	272.0 psi

Load Combination Results

Load Combination	C _D	C _P	Maximum Axial + Bending Stress Ratios			Maximum Shear Ratios		
			Stress Ratio	Status	Location	Stress Ratio	Status	Location
+D+H	0.900	0.521	0.3695	PASS	0.0 ft	0.0	PASS	8.0 ft
+D+L+H	1.000	0.482	1.244	FAIL !	0.0 ft	0.0	PASS	8.0 ft
+D+Lr+H	1.250	0.403	0.3443	PASS	0.0 ft	0.0	PASS	8.0 ft
+D+S+H	1.150	0.432	0.3494	PASS	0.0 ft	0.0	PASS	8.0 ft
+D+0.750Lr+0.750L+H	1.250	0.403	0.9788	PASS	0.0 ft	0.0	PASS	8.0 ft
+D+0.750L+0.750S+H	1.150	0.432	0.9933	PASS	0.0 ft	0.0	PASS	8.0 ft
+D+0.60W+H	1.600	0.326	0.3327	PASS	0.0 ft	0.0	PASS	8.0 ft
+D+0.750Lr+0.750L+0.450W+H	1.600	0.326	0.9457	PASS	0.0 ft	0.0	PASS	8.0 ft
+D+0.750L+0.750S+0.450W+H	1.600	0.326	0.9457	PASS	0.0 ft	0.0	PASS	8.0 ft
+0.60D+0.60W+0.60H	1.600	0.326	0.1996	PASS	0.0 ft	0.0	PASS	8.0 ft
+D+0.70E+0.60H	1.600	0.326	0.3327	PASS	0.0 ft	0.0	PASS	8.0 ft
+D+0.750L+0.750S+0.5250E+H	1.600	0.326	0.9457	PASS	0.0 ft	0.0	PASS	8.0 ft

Title Block Line 1
 You can change this area
 using the "Settings" menu item
 and then using the "Printing &
 Title Block" selection.
 Title Block Line 6

Project Title:
 Engineer:
 Project ID:
 Project Descr:

Printed: 6 MAY 2020, 3:25PM

File: California St.ec6

Software copyright ENERCALC, INC. 1983-2020. Build: 12.20.2.28

RA STRUCTURAL ENGINEERING

Wood Column

Lic. #: KW-06005737

DESCRIPTION: (E) 2-2x6

Load Combination Results

Load Combination	C _D	C _P	Maximum Axial + Bending Stress Ratios			Maximum Shear Ratios		
			Stress Ratio	Status	Location	Stress Ratio	Status	Location
+0.60D+0.70E+H	1.600	0.326	0.1996	PASS	0.0 ft	0.0	PASS	8.0 ft

Maximum Reactions

Note: Only non-zero reactions are listed.

Load Combination	X-X Axis Reaction		k	Y-Y Axis Reaction		Axial Reaction	My - End Moments		k-ft	Mx - End Moments	
	@ Base	@ Top		@ Base	@ Top		@ Base	@ Top		@ Base	@ Top
+D+H						1.889					
+D+L+H						6.529					
+D+Lr+H						1.889					
+D+S+H						1.889					
+D+0.750Lr+0.750L+H						5.369					
+D+0.750L+0.750S+H						5.369					
+D+0.60W+H						1.889					
+D+0.750Lr+0.750L+0.450W+H						5.369					
+D+0.750L+0.750S+0.450W+H						5.369					
+0.60D+0.60W+0.60H						1.133					
+D+0.70E+0.60H						1.889					
+D+0.750L+0.750S+0.5250E+H						5.369					
+0.60D+0.70E+H						1.133					
D Only						1.889					
Lr Only											
L Only						4.640					
S Only											
W Only											
E Only											
H Only											

Maximum Deflections for Load Combinations

Load Combination	Max. X-X Deflection	Distance	Max. Y-Y Deflection	Distance
+D+H	0.0000 in	0.000 ft	0.000 in	0.000 ft
+D+L+H	0.0000 in	0.000 ft	0.000 in	0.000 ft
+D+Lr+H	0.0000 in	0.000 ft	0.000 in	0.000 ft
+D+S+H	0.0000 in	0.000 ft	0.000 in	0.000 ft
+D+0.750Lr+0.750L+H	0.0000 in	0.000 ft	0.000 in	0.000 ft
+D+0.750L+0.750S+H	0.0000 in	0.000 ft	0.000 in	0.000 ft
+D+0.60W+H	0.0000 in	0.000 ft	0.000 in	0.000 ft
+D+0.750Lr+0.750L+0.450W+H	0.0000 in	0.000 ft	0.000 in	0.000 ft
+D+0.750L+0.750S+0.450W+H	0.0000 in	0.000 ft	0.000 in	0.000 ft
+0.60D+0.60W+0.60H	0.0000 in	0.000 ft	0.000 in	0.000 ft
+D+0.70E+0.60H	0.0000 in	0.000 ft	0.000 in	0.000 ft
+D+0.750L+0.750S+0.5250E+H	0.0000 in	0.000 ft	0.000 in	0.000 ft
+0.60D+0.70E+H	0.0000 in	0.000 ft	0.000 in	0.000 ft
D Only	0.0000 in	0.000 ft	0.000 in	0.000 ft
Lr Only	0.0000 in	0.000 ft	0.000 in	0.000 ft
L Only	0.0000 in	0.000 ft	0.000 in	0.000 ft
S Only	0.0000 in	0.000 ft	0.000 in	0.000 ft
W Only	0.0000 in	0.000 ft	0.000 in	0.000 ft
E Only	0.0000 in	0.000 ft	0.000 in	0.000 ft
H Only	0.0000 in	0.000 ft	0.000 in	0.000 ft

Title Block Line 1
You can change this area
using the "Settings" menu item
and then using the "Printing &
Title Block" selection.
Title Block Line 6

Project Title:
Engineer:
Project ID:
Project Descr:

Printed: 6 MAY 2020, 3:25PM

File: California Stec6

Software copyright ENERCALC, INC. 1983-2020, Build:12.20.2.28

RA STRUCTURAL ENGINEERING

Wood Column

Lic. #: KW-06005737

DESCRIPTION: (E) 2-2x6

Sketches

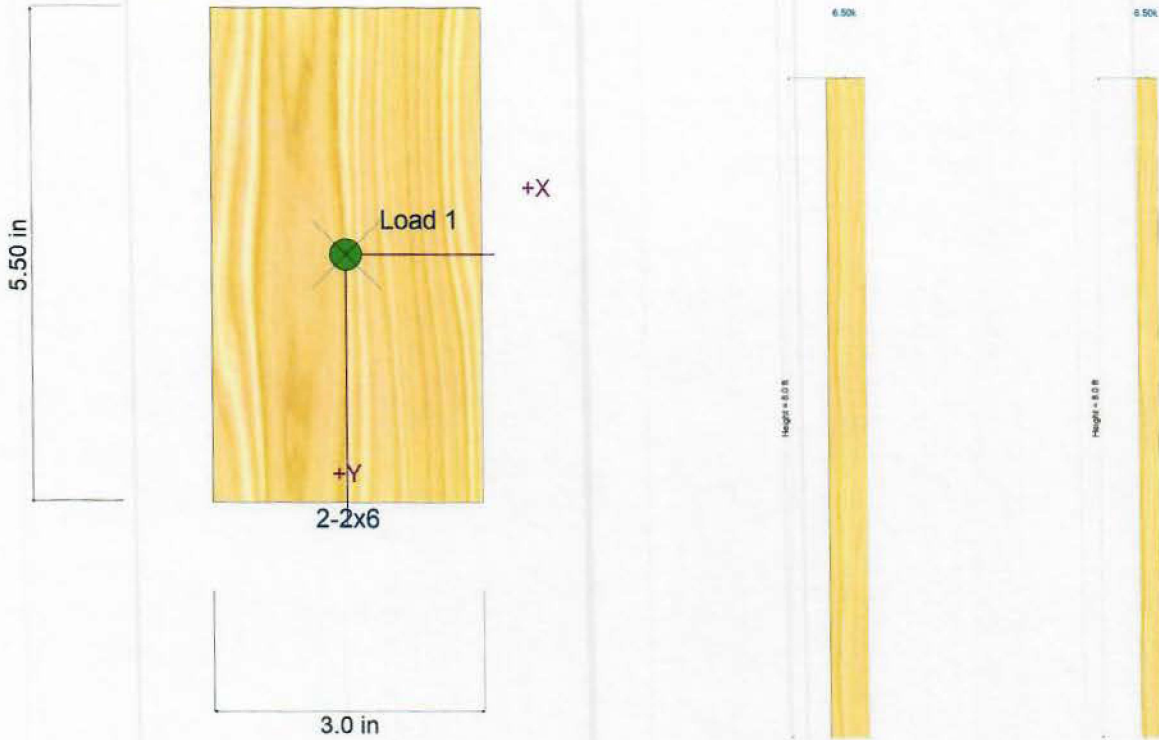

Search Information

Address: 805 W Cedar St, San Diego, CA 92101, USA
Coordinates: 32.7217636, -117.170476
Elevation: 17 ft
Timestamp: 2020-05-06T22:29:03.012Z
Hazard Type: Seismic
Reference Document: ASCE7-16
Risk Category: I
Site Class: D



Basic Parameters

Name	Value	Description
S_S	1.47	MCE_R ground motion (period=0.2s)
S_1	0.497	MCE_R ground motion (period=1.0s)
S_{MS}	1.47	Site-modified spectral acceleration value
S_{M1}	* null	Site-modified spectral acceleration value
S_{DS}	0.98	Numeric seismic design value at 0.2s SA
S_{D1}	* null	Numeric seismic design value at 1.0s SA

* See Section 11.4.8

Additional Information

Name	Value	Description
SDC	* null	Seismic design category
F_a	1	Site amplification factor at 0.2s
F_v	* null	Site amplification factor at 1.0s
CR_S	0.863	Coefficient of risk (0.2s)
CR_1	0.877	Coefficient of risk (1.0s)
PGA	0.668	MCE_G peak ground acceleration
F_{PGA}	1.1	Site amplification factor at PGA
PGA_M	0.735	Site modified peak ground acceleration

T _L	8	Long-period transition period (s)
SsRT	1.47	Probabilistic risk-targeted ground motion (0.2s)
SsUH	1.704	Factored uniform-hazard spectral acceleration (2% probability of exceedance in 50 years)
SsD	2.263	Factored deterministic acceleration value (0.2s)
S1RT	0.497	Probabilistic risk-targeted ground motion (1.0s)
S1UH	0.567	Factored uniform-hazard spectral acceleration (2% probability of exceedance in 50 years)
S1D	0.797	Factored deterministic acceleration value (1.0s)
PGAd	0.939	Factored deterministic acceleration value (PGA)

* See Section 11.4.8

The results indicated here DO NOT reflect any state or local amendments to the values or any delineation lines made during the building code adoption process. Users should confirm any output obtained from this tool with the local Authority Having Jurisdiction before proceeding with design.

Disclaimer

Hazard loads are provided by the U.S. Geological Survey [Seismic Design Web Services](#).

While the information presented on this website is believed to be correct, ATC and its sponsors and contributors assume no responsibility or liability for its accuracy. The material presented in the report should not be used or relied upon for any specific application without competent examination and verification of its accuracy, suitability and applicability by engineers or other licensed professionals. ATC does not intend that the use of this information replace the sound judgment of such competent professionals, having experience and knowledge in the field of practice, nor to substitute for the standard of care required of such professionals in interpreting and applying the results of the report provided by this website. Users of the information from this website assume all liability arising from such use. Use of the output of this website does not imply approval by the governing building code bodies responsible for building code approval and interpretation for the building site described by latitude/longitude location in the report.

OUT OF PLANE LOAD - CMU WALL

ANCHORAGE - TIE BACK LOAD

ASCE 7-16- SECTION 12.11.2.1

$$F_p = 0.4 S_{DS} K_a I_e W_p$$

$$K_a = 1 + \frac{L_e}{100} = 1 + \frac{60}{100} = 1.6$$

$$F_p = 0.4 (0.98) (1.6) (1) (100) = 62.72 \text{ PSF}$$

$$8" \text{ CMU WALL} = \frac{8}{12} \times 150 = 100 \text{ PSF}$$

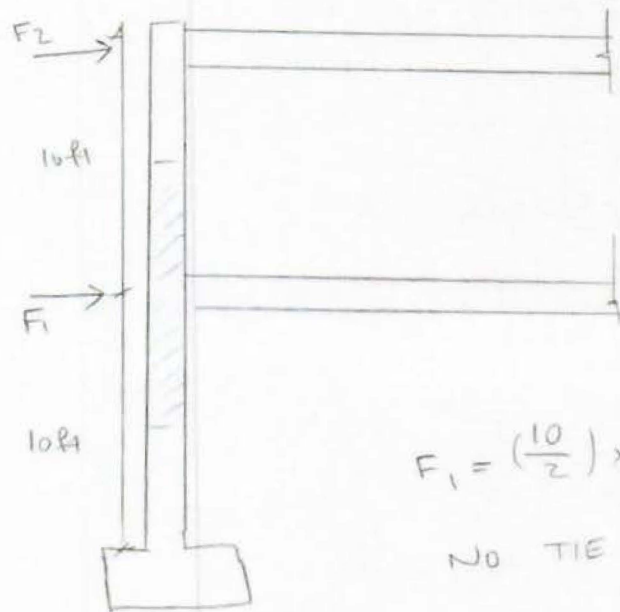

$$F_1 = \left(\frac{10}{2}\right) \times 2 \times 62.72 = 627 \text{ PLF}$$

NO TIE - OUT OF PLANE PROVIDED

$$F_2 = \left(\frac{10}{2}\right) \times 62.72 = 313.5 \text{ PLF}$$

APPENDIX C – SITE PLAN



APPENDIX D – AS-BUILT PLANS

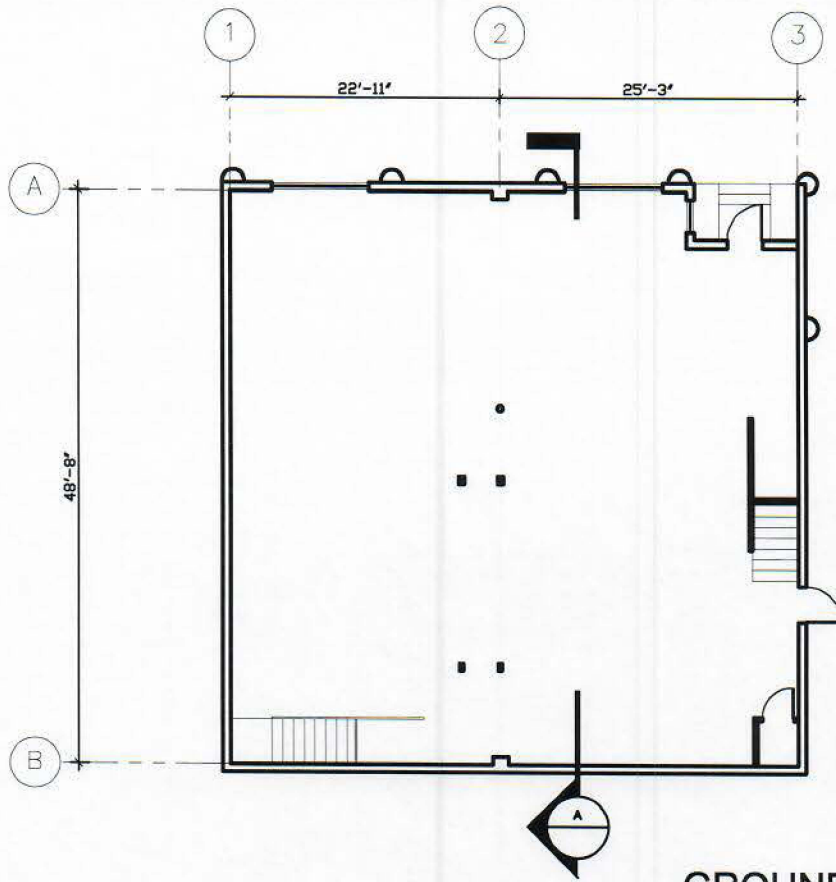

GROUND FLOOR

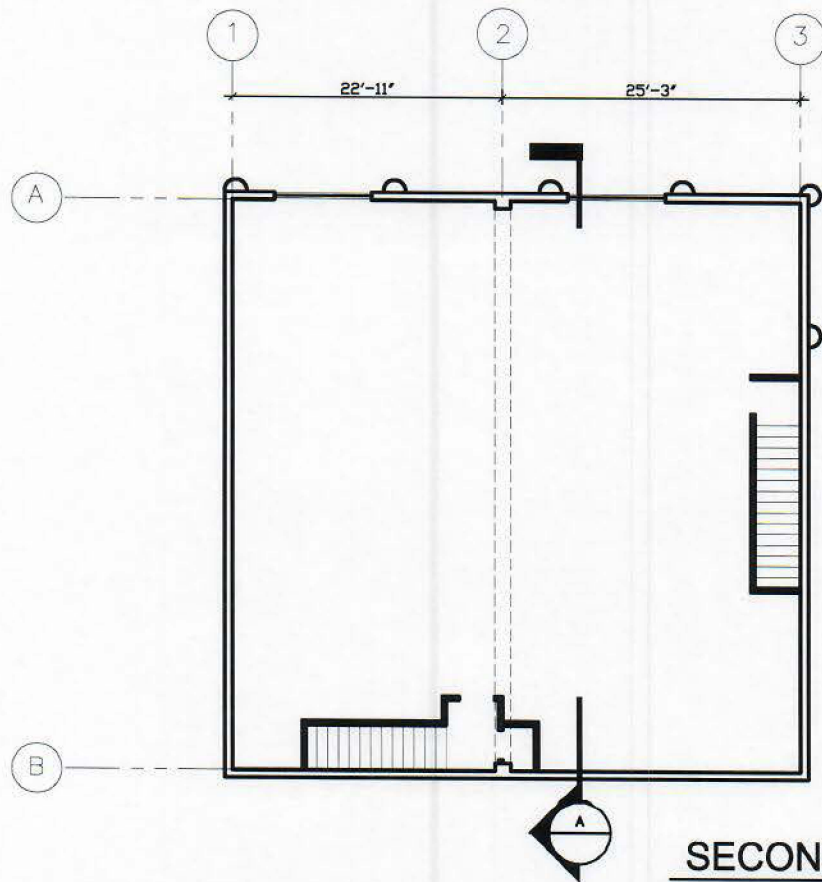

SECOND FLOOR



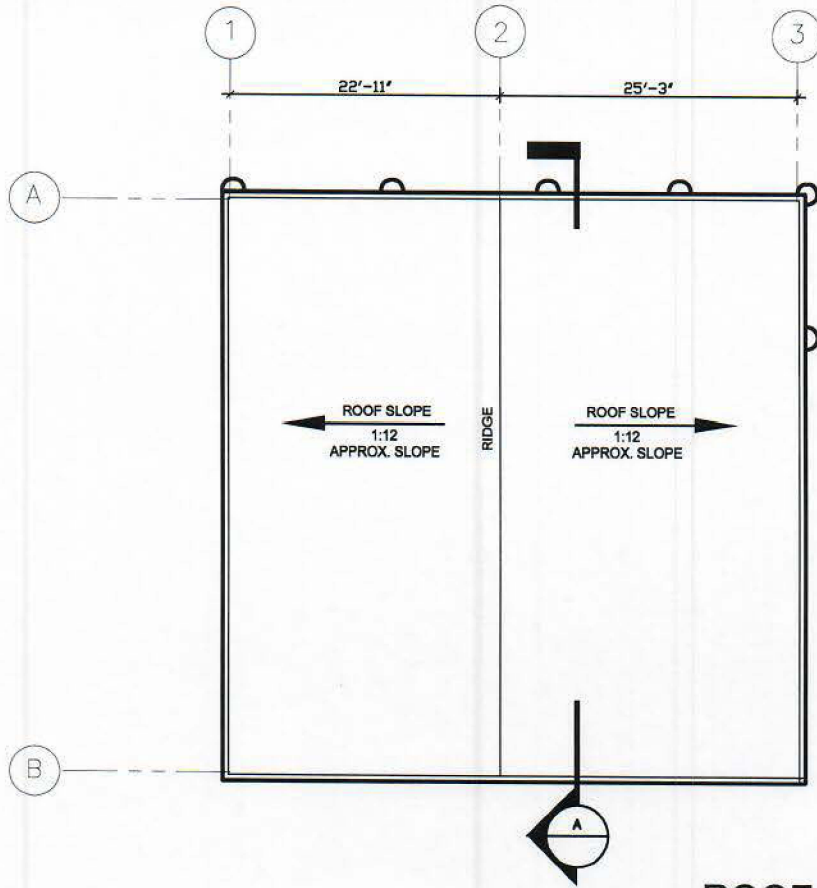

ROOF PLAN

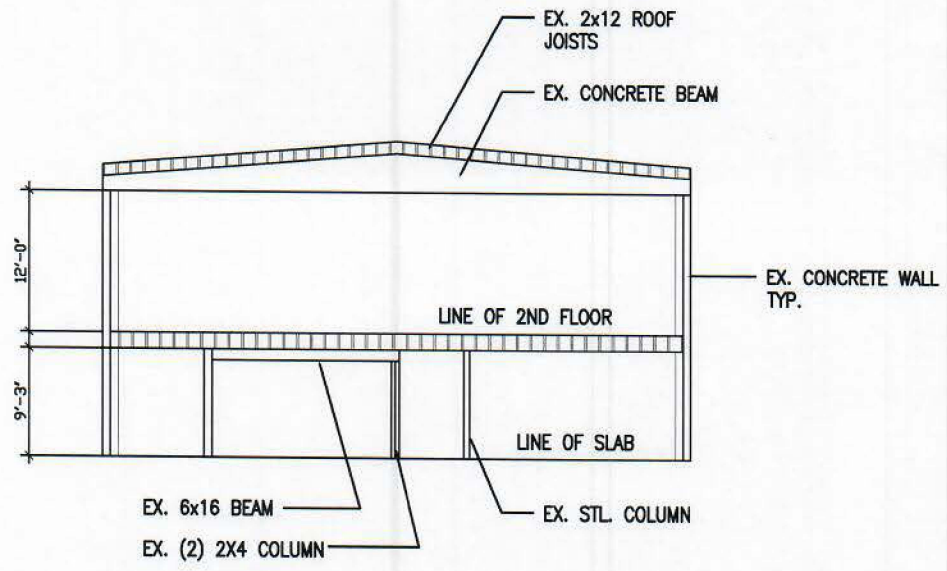

BUILDING SECTION A

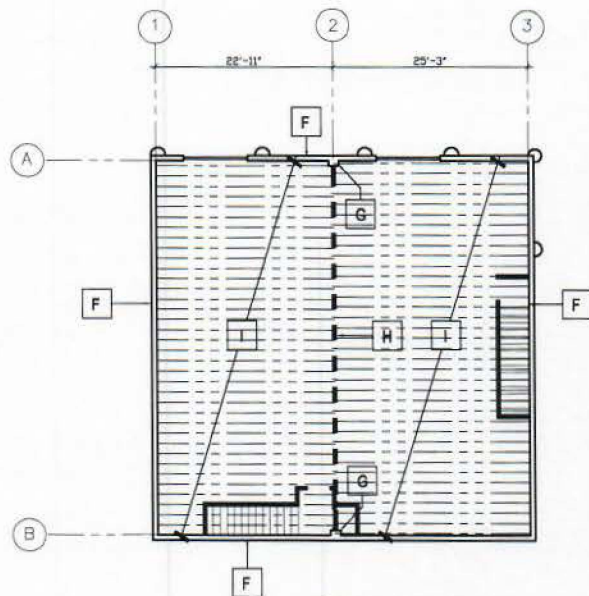

SECOND FLOOR

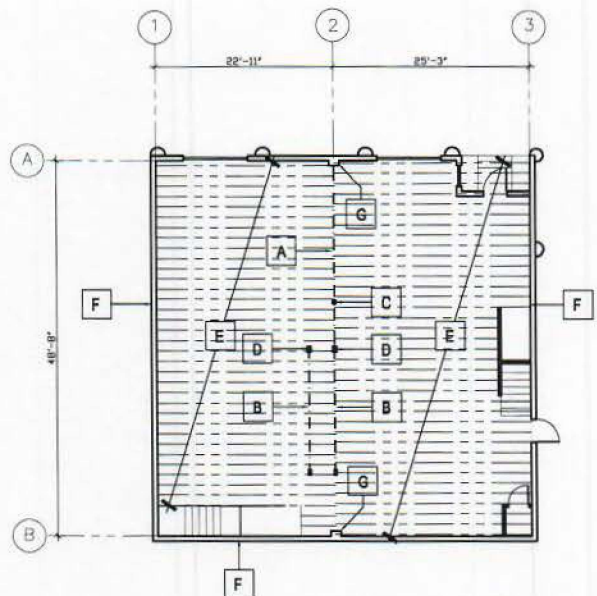

GROUND FLOOR

FRAMING MEMBERS KEYNOTES

A	EXISTING W16x40 STEEL BEAM.	F	EXISTING CONCRETE WALL.
B	EXISTING 2x18 BEAM	G	EXISTING CONCRETE COLUMN
C	EXISTING 4" DIAMETER COLUMN	H	EXISTING CONCRETE BEAM
D	EXISTING (2) 2x4 POSTS	I	EXISTING 2x12 @ 16" O.C.
E	EXISTING 2x16 AT 12" O.C.		

AS-BUILT FRAMING PLAN
805 W. CEDAR STREET



**APPENDIX E – SUPPLEMENTAL
PHOTOS**



DESCRIPTION:

1. INSUFFICIENT BEAM POST CONNECTION WITH NO HARDWARE. BEAM TOE-NAILED TO POST.

1ST FLOOR

COLUMN & WOOD BEAMS

805 W. CEDAR STREET



DESCRIPTION:

- 1. WATER DAMAGED ROOF FRAMING MEMBERS**
- 2. WATER DAMAGE AT FLOOR. FLOOR JOISTS AND PLYWOOD DIAPHRAGM HAVE INCURRED SUBSTANTIAL DAMAGE.**

2ND FLOOR

CONCRETE BEAM

805 W. CEDAR STREET



DESCRIPTION:

- 1. WATER DAMAGED ROOF FRAMING MEMBERS**

2ND FLOOR
INTERIOR CEILING

805 W. CEDAR STREET

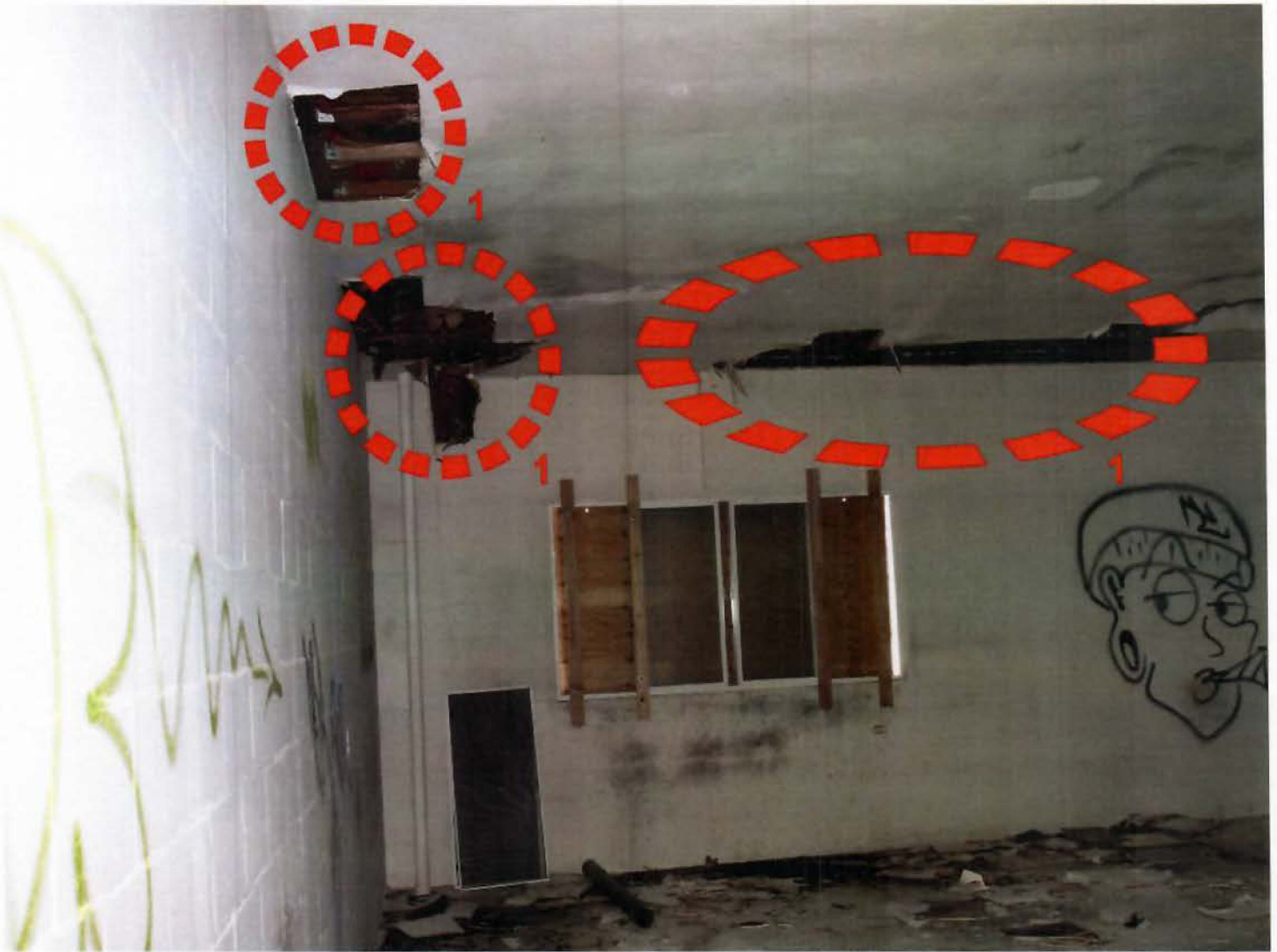

DESCRIPTION:

- 1. WATER DAMAGED ROOF FRAMING MEMBERS**

2ND FLOOR

INTERIOR CEILING

805 W. CEDAR STREET



THE CITY OF SAN DIEGO

Report to the Historical Resources Board

DATE ISSUED: March 11, 2021 REPORT NO. HRB-21-023

HEARING DATE: March 25, 2021

SUBJECT: **ITEM #1 – Vulcan Steam Room and Sauna**

RESOURCE INFO: [California Historical Resources Inventory Database \(CHRID\) link](#)

APPLICANT: I P Investments, LLC; represented by Scott Moomjian

LOCATION: 805 West Cedar Street, Downtown Community, Council District 3
APN 533-321-09-00

DESCRIPTION: Consider the designation of the Vulcan Steam Room and Sauna located at 805 West Cedar Street as a historical resource.

STAFF RECOMMENDATION

Designate the Vulcan Steam Room and Sauna located at 805 West Cedar Street as a historical resource with a period of significance of 1974-1988 under HRB Criteria A and B. The designation excludes the one-story property located at 1560 California Street. This recommendation is based on the following findings:

1. The resource, which is significant for its association with the LGBTQ community, reflects a special element of San Diego's historical, cultural, and social development and retains integrity to its 1974-1988 period of significance. Specifically, the Vulcan Steam Room and Sauna provided a private, safe space for gay men to meet, socialize, and engage in discrete sexual activities at a time when homosexuality was not only condemned, but prior to 1976, illegal. Additionally, the Vulcan Steam Room and Sauna provided emotional support and information to its members regarding sexually transmitted diseases and how best to protect themselves from infection during the height of the HIV/AIDS epidemic when the disease was poorly understood and highly stigmatized.
2. The resource is identified with Frank Stiriti, a historically significant person and retains integrity for his association. Specifically, Frank Stiriti was the owner and founder of the Vulcan Steam Room and Sauna and was also an advocate, educator, and volunteer for the LGBTQ community, especially during the AIDS crisis in San Diego.

BACKGROUND

This item is being brought before the Historical Resources Board in conjunction with a proposed building modification or demolition of a structure of 45 years or more, consistent with [San Diego Municipal Code Section 143.0212](#). The subject resource is located in Downtown San Diego at the beginning of the southside of West Cedar Street adjacent to the Pacific Highway and the County Administration Building.

The property was identified in the [2016 San Diego Citywide LGBTQ Historic Context Statement](#) and for its association with the Lesbian, Gay, Bisexual, Transgender, and Queer (LGBTQ) community's "Social Life" contextual theme.

The property located at 1560 California Street was evaluated by staff and cleared from further historic review through the Potential Historic Resource Review process. The property dates to circa 1907 and was originally constructed as an early 20th century masonry commercial building. Staff found that the property did not rise to the level of individual designation nor warranted further evaluation through a Historical Resources Research Report.

The historic name of the resource, the Vulcan Steam Room and Sauna, has been identified consistent with the Board's adopted naming policy and reflects the name of the tenant that occupied the property during its 39 years of operation.

PRIOR REPORT

In 2019, Scott Moomjian submitted a Historical Resource Research Report for 805 West Cedar Street for staff's review. This report was never deemed complete nor resubmitted with the edits requested by staff, however some of the primary research in the Moomjian report was included in the current Historical Resource Research Report prepared by Brian F. Smith and Associates.

ANALYSIS

A Historical Resource Research Report was prepared by Brian F. Smith and Associates, which concludes that the resource is significant under HRB Criteria A and B and staff concurs. This determination is consistent with the *Guidelines for the Application of Historical Resources Board Designation Criteria*, as follows.

CRITERION A - Exemplifies or reflects special elements of the City's, a community's or a neighborhood's historical, archaeological, cultural, social, economic, political, aesthetic, engineering, landscaping or architectural development.

The subject property located at 805 West Cedar Street, known as the Vulcan Steam Room and Sauna, was one of the seven identified bathhouses within the City of San Diego and was one of the last extant operating bathhouses in the City upon its closure in 2013. As noted in the *2016 San Diego Citywide LGBT Historic Context Statement*, the first documented bathhouse in the City opened in 1869. Bathhouses at this time served as swimming pools for relaxation as well as bathing spots for those without indoor plumbing. The city's earliest bathhouses were located on the waterfront and were seasonal, family-friendly attractions eventually evolving into gay destinations due to their separate men's and women's

facilities. The construction of bathhouses later spread inland and became year-round venues with additional services such as massages, saunas, and other spa features. The gay activities occurring within the bathhouses at this time were secretive with the businesses maintaining heterosexual public fronts and clients, alongside their gay patrons. Bathhouses served as a safe space for many men at this time who resorted to having sex in public and semi-public places out of fear that their landlords or neighbors would discover their true identities, effectively ruining their lives and careers. The construction of bathhouses increased in San Diego with the 1975 passage of California's Consenting Adult Sex Bill, which repealed the law against sodomy and legalized sex between men.

From its inception in July of 1974, the Vulcan Steam Room and Sauna provided a private, safe space during a period of history when physical and romantic relationships between men were not only condemned by society but prior to 1976 were illegal. Frank Stiriti, a gay man as well as the owner and founder of the Vulcan Steam Room and Sauna, aimed to create a recreational facility in conservative San Diego where gay men could find one another. He operated a steady business into the mid-1980s when the AIDS crisis began to emerge throughout the United States. However, he did not close his business like many other local bathhouse owners did during the escalation of the AIDS crisis as requested by San Diego's Board of Supervisors in 1988 to reduce the spread of AIDS. Instead, he used the Vulcan Steam Room and Sauna as a meeting place to engage with community members ways in which to prevent the spread of sexually transmitted diseases, HIV, and AIDS through self-made brochures and advocating for safe sex practices through the distribution of free condoms upon entrance of the building. The brochures were prepared and paid for by Frank Stiriti as there was no government funding for AIDS related literature at this time. The space was later used for seminars on AIDS related resources and quickly became a vital information source for people who did not feel comfortable going to The Center for Social Services (presently The San Diego LGBT Community Center) in Hillcrest.

When considering a potential period of significance for the subject property, staff considered two options. A period of significance which reflected the entire period in which the building operated as a bathhouse would take the period of significance from 1974-2013, which is quite recent and raises questions regarding appropriate historical perspective. When considering that the significance is derived in large part by the Vulcan Steam Room and Sauna serving as a safe, private space for men to meet and engage in discrete sexual activities when it was illegal to do so to providing information on the AIDS crisis when it was highly stigmatized, staff finds that that ending the period of significance when bathhouses in San Diego were requested to close to reduce the spread of AIDS in 1988, which the Vulcan Steam Room and Sauna did not abide by, an appropriate period of time. Therefore, staff has concluded that limiting the period of significance to 1974-1988 for the years that the Vulcan Steam Room and Sauna opened its doors and remained open to provide a safe, private space for men to meet, engage in discrete sexual activities as well as a venue to learn more about the AIDS crisis during a period of time when limited information and resources were available for the highly stigmatized disease.

Significant properties related to the "Social Life" contextual theme within the *2016 San Diego Citywide LGBT Historic Context Statement*, are directly associated with the development of the LGBTQ social scene. The Vulcan Steam Room and Sauna was a significant historical, cultural and social place of interaction for gay men and continues to retain integrity of location, feeling, design, materials, workmanship, and association as related to HRB Criterion A.

Significance Statement: The Vulcan Steam Room and Sauna, located at 805 West Cedar Street, provided a private, safe space for gay men to meet, socialize, and engage in discrete sexual activities at a time when homosexuality was not only condemned, but prior to 1976, illegal. Additionally, the Vulcan Steam Room and Sauna provided emotional support and information to its members regarding sexually transmitted diseases and how best to protect themselves from infection during the height of the HIV/AIDS epidemic when the disease was poorly understood and highly stigmatized. Therefore, staff recommends designation of the resource located at 805 West Cedar Street under HRB Criterion A.

CRITERION B - Is identified with persons or events significant in local, state or national history.

The subject property located at 805 West Cedar Street is significant for its association with Frank Stiriti, the founder and owner of the Vulcan Steam Room and Sauna. Frank Stiriti was born in 1944 in Massachusetts and graduated from Northern University in Boston. He first visited San Diego in 1968 while stationed in the Navy and would later return with his then partner, Joe O'Toole. With the help of his business partner Don Schermerhorn, whom he had met while serving in Vietnam, the Vulcan Steam Room and Sauna opened in 1974. In the beginning one of the three, Stiriti, O'Toole, or Schermerhorn, were present on site. Later, they were able to hire six employees total who were paid an hourly wage as well as insurance and health benefits. With the onset of the AIDS crisis in the early 1980s, Stiriti worked with Jess Jessop, who founded The Center for Social Services in Hillcrest, to provide seminars as well as prepared literature to distribute to patrons about safe sex practices. Stiriti also stepped forward to fund the literature since government funding was not earmarked for addressing these issues at this time.

Along with being a business owner, Stiriti has been a longtime donor to LGBTQ and HIV and AIDS organizations. San Diego City Human Relations Commissioner Nicole Murray-Ramirez noted that Frank Stiriti was directly responsible for the AIDS Assistance Fund's food shelves being stocked during the early days of the AIDS epidemic and was responsible for donating thousands of dollars to the LGBTQ community throughout the Vulcan Steam Room and Sauna's operation. In recent history Stiriti has been acknowledged for his efforts within the LGBTQ community and he was inducted into the Community Wall of Honor located at The San Diego LGBT Community Center as well as the San Diego's LGBT Veteran's Wall of Honor.

Frank Stiriti is a significant individual within San Diego's LGBTQ community and is best associated with his ownership and operation of the Vulcan Steam Room and Sauna within its 1974-1988 period of significance for not only providing a safe space for gay men to be themselves during a period of time when it was illegal to do so, but for utilizing the Vulcan Steam Room and Sauna for lectures and distribution of self-made AIDS related literature during the height of the AIDS crisis, specifically during a time when the disease was poorly understood and highly stigmatized. Therefore, staff finds that the resource continues to retain integrity of location, feeling, design, materials, workmanship, and association as related to HRB Criterion B.

Significance Statement: The subject resource was owned and operated by Frank Stiriti during the its 39 years of operation. Throughout this time, Stiriti provide a safe space for gay men to meet and engage in sexual activities and was an early advocate, educator and donor to San Diego's LGBTQ community, specifically during the AIDS crisis. Therefore, staff recommends designation of the resource located at 805 West Cedar Street under HRB Criterion B.

CRITERION C - Embodies distinctive characteristics of a style, type, period or method of construction or is a valuable example of the use of natural materials or craftsmanship.

The subject property located at 805 West Cedar Street was constructed as an addition to the front façade of the Pioneer Printers building located at 1560 California Street in 1961. In its current condition, the property is a combination of the Block and Utilitarian Industrial architectural styles with the primary elevation of the site featuring an off centered, deeply recessed entrance with evenly spaced, semicircular Doric columns, a smooth stucco finish and two covered window openings. The side and rear elevations feature limited details other than the continuation of the same stucco texture and one Doric column along the east façade.

When the property was first constructed in 1961, it was originally for an addition to the Pioneer Printers located at the rear of the lot. At that time, the building featured a masonry façade with "Pioneer Printers" displayed around the parapet and did not include any window openings along the primary elevation. Modifications since its 1961 construction include the addition of ceramic tile veneer to the northeast corner between 1969 and 1976, the addition of a first-floor window opening on the north façade in 1972, sun deck and patio construction on the east façade between 1974 and 1976, changes to the "805 West Cedar Street" sign, the addition of stucco finish and Doric semicircular columns and window boarding between 1976-2007.

In 2014 the subject property experienced exterior modifications without the benefit of a permit. These modifications occurred on the primary elevation and included the addition of one new window on the second story, two operable windows within the existing boarded window openings, and the removal of a column along the east facing, side elevation. Since these modern modifications were done without the benefit of a permit, they are not considered an impact to the integrity of the building at this time.

While the property does retain its original square footprint and general form, extensive exterior modifications have cumulatively impacted the design, workmanship, and materials which are the significance aspects of integrity related to HRB Criterion C. Therefore, due to substantial alterations and a lack of character defining features of any recognized style, staff does not recommend designation under HRB Criterion C.

CRITERION D - Is representative of a notable work of a master builder, designer, architect, engineer, landscape architect, interior designer, artist or craftsman.

The subject property located at 805 West Cedar Street was built by the C.A. Larsen Construction Company in 1961 as an addition to the Pioneer Printers building located at 1560 California Street. The property which was later separately addressed as 805 West Cedar Street was modified throughout its period of significance by Stanley Brune, Julian V. Thompson, PBD Arch, Max Gurth, Bob Smith, and Guy Irwin. None of these architects or builders have been established by the Historical Resources Board as a Master Architect, Designer or Builder, and there is insufficient information to designate them as such at this time. Therefore, staff does not recommend designation under HRB Criterion D.

CRITERION E - Is listed or has been determined eligible by the National Park Service for listing on the National Register of Historic Places or is listed or has been determined eligible by the State Historical Preservation Office for listing on the State Register of Historical Resources.

The property at 805 West Cedar Street has not been listed on or determined eligible for listing on the State or National Registers. Therefore, the property is not eligible for designation under HRB Criterion E.

CRITERION F - Is a finite group of resources related to one another in a clearly distinguishable way or is a geographically definable area or neighborhood containing improvements which have a special character, historical interest or aesthetic value or which represent one or more architectural periods or styles in the history and development of the City.

The property at 805 West Cedar Street is not located within a designated historic district. Therefore, the property is not eligible for designation under HRB Criterion F.

OTHER CONSIDERATIONS

Designation brings with it the responsibility of maintaining the building in accordance with the Secretary of the Interior's Standards. The benefits of designation include the availability of the Mills Act Program for reduced property tax; the use of the more flexible Historical Building Code; flexibility in the application of other regulatory requirements; the use of the Historical Conditional Use Permit which allows flexibility of use; and other programs which vary depending on the specific site conditions and owner objectives. If the property is designated by the HRB, conditions related to restoration or rehabilitation of the resource may be identified by staff during the Mills Act application process, and included in any future Mills Act contract.

CONCLUSION

Based on the information submitted and staff's field check, it is recommended that the Vulcan Steam Room and Sauna located at 805 West Cedar Street be designated with a period of significance of 1974-1988 under HRB Criteria A as a special element of San Diego's historical, cultural, and social development and Criteria B, for its association with Frank Stiriti, a historically significant individual. The designation excludes the one-story property addressed at 1560 California Street.



Emma Haggerty
Senior Planner
Development Services Department

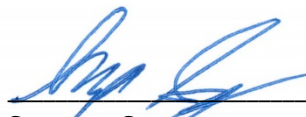

Suzanne Segur
Senior Planner/ HRB Liaison
Development Services Department

EH/ks/ss

Attachment(s):

1. Draft Resolution
2. Applicant's Historical Report under separate cover

RESOLUTION NUMBER N/A
ADOPTED ON 3/25/2021

WHEREAS, the Historical Resources Board of the City of San Diego held a noticed public hearing on 3/25/2021, to consider the historical designation of the Vulcan Steam Room and Sauna (owned by I P Investments LLC, 908 Southmore Avenue #270, Pasadena, CA 77502) located at **805 West Cedar Street, San Diego, CA 92101**, APN: **533-321-09-00**, further described as LOT 12 R/W in the City of San Diego, County of San Diego, State of California; and

WHEREAS, in arriving at their decision, the Historical Resources Board considered the historical resources report prepared by the applicant, the staff report and recommendation, all other materials submitted prior to and at the public hearing, inspected the subject property and heard public testimony presented at the hearing; and

WHEREAS, the property would be added to the Register of Designated Historical Resources as **Site No. ,** and

WHEREAS, designated historical resources located within the City of San Diego are regulated by the Municipal Code (Chapter 14, Article 3, Division 2) as such any exterior modifications (or interior if any interior is designated) shall be approved by the City, this includes but is not limited to modifications to any windows or doors, removal or replacement of any exterior surfaces (i.e. paint, stucco, wood siding, brick), any alterations to the roof or roofing material, alterations to any exterior ornamentation and any additions or significant changes to the landscape/ site.

NOW, THEREFORE,

BE IT RESOLVED, the Historical Resources Board based its designation of the Vulcan Steam Room and Sauna on the following findings:

(1) The property is historically significant under CRITERION A for its association with the LGBTQ community and reflects a special element of San Diego's historical, cultural, and social development and retains integrity to its 1974-1988 period of significance. Specifically, the Vulcan Steam Room and Sauna provided a private, safe space for gay men to meet, socialize, and engage in discrete sexual activities at a time when homosexuality was not only condemned, but prior to 1976, illegal. Additionally, the Vulcan Steam Room and Sauna provided emotional support and information to its members regarding sexually transmitted diseases and how best to protect themselves from infection during the height of the HIV/AIDS epidemic when the disease was poorly understood and highly stigmatized. This finding is further supported by the staff report, the historical research report, and written and oral evidence presented at the designation hearing.

(2) The property is historically significant under CRITERION B for its association with Frank Stiriti, a historically significant person and retains integrity for his association. Specifically, Frank Stiriti was the owner and founder of the Vulcan Steam Room and Sauna and was also an advocate, educator, and volunteer for the LGBTQ community, especially during the AIDS crisis in San Diego. This finding is further supported by the staff report, the historical research report, and written and oral evidence presented at the designation hearing.

BE IT FURTHER RESOLVED, in light of the foregoing, the Historical Resources Board of the City of San Diego hereby approves the historical designation of the above named property. The designation includes the parcel and exterior of the building as Designated Historical Resource **Site No. .**

BE IT FURTHER RESOLVED, the designation shall exclude the one-story property located at 1560 California Street.

BE IT FURTHER RESOLVED, the Secretary to the Historical Resources Board shall cause this resolution to be recorded in the office of the San Diego County Recorder at no fee, for the benefit of the City of San Diego, and with no documentary tax due.

Vote:

BY: _____
DAVID MCCULLOUGH, Chair
Historical Resources Board

APPROVED: MARA W. ELLIOTT,
CITY ATTORNEY

BY: _____
LINDSEY SEBASTIAN,
Deputy City Attorney