



Air Quality and Health Risk
Technical Analyses for the
Barrio Logan Community
Plan Update,
City of San Diego,
California

Prepared for

City of San Diego
202 C Street, MS-4A
San Diego, CA 92101
Contact: Lara Gates

Prepared by

RECON Environmental, Inc.
1927 Fifth Avenue
San Diego, CA 92101-2358
P 619.308.9333 F 619.308.9334
RECON Number 4716
August 16, 2012

This page is intentionally blank.

TABLE OF CONTENTS

1.0	Summary	1
2.0	Introduction and Project Description	1
3.0	Regulatory Framework	3
3.1	Federal Regulations	4
3.2	State Regulations	9
3.3	State Implementation Plan	14
3.4	The California Environmental Quality Act	14
3.5	Regional Air Quality Strategy	15
4.0	Environmental Setting	15
4.1	Geographic Setting	15
4.2	Climate	15
4.3	Existing Air Quality—Criteria Pollutants	16
4.4	Regional Background Toxic Air Pollutants	23
4.5	Previous Air Quality Monitoring Studies in the Barrio Logan Area	23
4.6	Other Air Pollution Control Efforts	32
5.0	Thresholds of Significance	34
5.1	California Air Resources Board	34
5.2	City of San Diego	34
5.3	Public Nuisance Law (Odors)	35
5.4	San Diego Air Pollution Control District	35
5.5	Evaluation of Air Toxic Emissions	37
6.0	Criteria Pollutant Air Quality Assessment	37
6.1	Methodology & Assumptions	37
6.2	Construction-related Air Quality Effects	38
6.3	Operation-related Emissions	41
7.0	Health Risk Assessment	49
7.1	Health Risk Assessment Process	49
7.2	Freeway Diesel Emissions	58
7.3	Truck Route Diesel Emissions	63
7.4	Train Diesel Emissions	65
7.5	Total Assessed Health Risk	76
8.0	Conformance with Regional Plans and City Criteria	78
8.1	California Air Resources Board	78
8.2	City of San Diego	80
9.0	Conclusions and Recommendations	82
10.0	References Cited	85

TABLE OF CONTENTS (CONT.)

TABLES

1:	Ambient Air Quality Standards	5
2:	Ambient Air Quality Summary—San Diego Air Basin	18
3:	Summary of Air Quality Measurements Recorded at the San Diego—1110 Beardsley Street Monitoring Station	19
4:	Pollutants Measured at Memorial Academy in a 12-Month Period	25
5:	Hexavalent Chromium Measurements, Barrio Logan	26
6:	4 th Quarter 2009 Port of San Diego Vessel Speed Reduction Emission Reductions	32
7:	Air Quality Impact Screening Levels	36
8:	Daily Construction Emissions	40
9:	Existing and Future Modeled Land Uses	42
10:	Existing Land Uses that Will Remain and Not Change	43
11:	Average Daily Operational Emissions to the San Diego Air Basin	46
12:	Ranking of Alternative Criteria Pollutant Emissions	47
13:	Diesel Particulate Matter Risk Data	51
14:	Point Estimates for Daily Breathing Rate for 9-, 30-, and 70-Year Exposure Durations	56
15:	Adjustment Factors to Convert Inhalation-based Cancer Risk Estimates for a Residential Receiver to a Worker Receiver	57
16:	Incremental Cancer Risk Diesel Particulate Matter Concentration Multiplication Factors	57
17:	Wind Direction and Relative Duration	60
18:	Locomotives Modeled	66
19:	Rail Line Operations	67
20:	Locomotive Diesel Particulate Matter Emission Factors	68
21:	Train Diesel Particulate Matter Emissions	69
22:	SCREEN3 Exhaust Parameters	73
23:	Exhaust Plume Rise and AERMOD Volume Source Parameters	74

ATTACHMENTS

1	Figures
1:	Regional Location of the Barrio Logan Community Plan Area
2:	Barrio Logan Community Plan Area on Aerial Photograph
3a:	Adopted Community Plan Land Uses
3b:	Alternative 1 Proposed Land Use
3c:	Revised Alternative 2 Proposed Land Use
4:	Regulatory and Jurisdictional Boundaries
5:	San Diego—1110 Beardsley Street Air Monitoring Station and Memorial Academy Charter School
6:	Hexavalent Chromium Sampling Locations
7:	SDIY Yard Incremental Cancer Risk Contours Overlain on the Adopted Community Plan Land Uses
8:	SDIY Yard Incremental Cancer Risk Contours Overlain on the Alternative 1 Community Plan Land Uses
9:	SDIY Yard Incremental Cancer Risk Contours Overlain on the Revised Alternative 2 Community Plan Land Uses

TABLE OF CONTENTS (CONT.)

ATTACHMENTS (CONT.)

- 1 Figures (cont.)
 - 10: BNSF Yard Incremental Cancer Risk Contours Overlain on the Adopted Community Plan Land Uses
 - 11: BNSF Yard Incremental Cancer Risk Contours Overlain on the Alternative 1 Community Plan Land Uses
 - 12: BNSF Yard Incremental Cancer Risk Contours Overlain on the Revised Alternative 2 Community Plan Land Uses
 - 13: BNSF Yard Study Off-Site Incremental Cancer Risk Contours Overlain on the Adopted Community Plan Land Uses
 - 14: BNSF Yard Study Off-Site Incremental Cancer Risk Contours Overlain on the Alternative 1 Community Plan Land Uses
 - 15: BNSF Yard Study Off-Site Incremental Cancer Risk Contours Overlain on the Revised Alternative 2 Community Plan Land Uses
 - 16: Prior Studies Estimated Combined Total Incremental Cancer Risk Contours Overlain on the Adopted Community Plan Land Uses
 - 17: Prior Studies Estimated Combined Total Incremental Cancer Risk Contours Overlain on the Alternative 1 Community Plan Land Uses
 - 18: Prior Studies Estimated Combined Total Incremental Cancer Risk Contours Overlain on the Revised Alternative 2 Community Plan Land Uses
 - 19: Surface Wind Rose for Lindbergh Field 2006 to 2010
 - 20: Modeled Freeway Receivers and Freeway Segments – Proposed CPU Alternatives 1 and 2
 - 21: Modeled Freeway Receivers and Freeway Segments – Adopted Community Plan
 - 22: Diesel Particulate 80th Percentile Residential Incremental Cancer Risk Contours due to Freeway Traffic Overlain on the Adopted Community Plan Land Uses
 - 23: Diesel Particulate 80th Percentile Residential Incremental Cancer Risk Contours due to Freeway Traffic Overlain on the Alternative 1 Community Plan Land Uses
 - 24: Diesel Particulate 80th Percentile Residential Incremental Cancer Risk Contours due to Freeway Traffic Overlain on the Revised Alternative 2 Community Plan Land Uses
 - 25: Diesel Particulate Worker Incremental Cancer Risk Contours due to Freeway Traffic Overlain on the Adopted Community Plan Land Uses
 - 26: Diesel Particulate Worker Incremental Cancer Risk Contours due to Freeway Traffic Overlain on the Alternative 1 Community Plan Land Uses
 - 27: Diesel Particulate Worker Incremental Cancer Risk Contours due to Freeway Traffic Overlain on the Revised Alternative 2 Community Plan Land Uses
 - 28: Modeled Truck Route Receivers and Truck Route Segments
 - 29: Diesel Particulate 80th Percentile Residential Incremental Cancer Risk Contours due to Truck Route Traffic Overlain on the Alternative 1 Community Plan Land Uses
 - 30: Diesel Particulate 80th Percentile Residential Incremental Cancer Risk Contours due to Truck Route Traffic Overlain on the Revised Alternative 2 Community Plan Land Uses
 - 31: Diesel Particulate Worker Incremental Cancer Risk Contours due to Truck Route Traffic Overlain on the Alternative 1 Community Plan Land Uses
 - 32: Diesel Particulate Worker Incremental Cancer Risk Contours due to Truck Route Traffic Overlain on the Revised Alternative 2 Community Plan Land Uses
 - 33: Locations of Rail Lines in Barrio Logan Area
 - 34: Modeled Rail Lines
 - 35: Meteorology Data Stations
 - 36: U.S. Census Bureau Census Blocks

TABLE OF CONTENTS (CONT.)

ATTACHMENTS (CONT.)

- 1 Figures (cont.)
 - 37: Urban Population
 - 38: Example Volume Source Layout
 - 39: Locomotive Exhaust Plume Rise
 - 40: Coordinate System for Gaussian Modeling
 - 41: Rail Line Grid Receivers
 - 42: Diesel Particulate 80th Percentile Residential Incremental Cancer Risk Contours due to Main Line Rail Operations Overlain on the Adopted Community Plan Land Uses
 - 43: Diesel Particulate 80th Percentile Residential Incremental Cancer Risk Contours due to Main Line Rail Operations Overlain on the Alternative 1 Community Plan Land Uses
 - 44: Diesel Particulate 80th Percentile Residential Incremental Cancer Risk Contours due to Main Line Rail Operations Overlain on the Revised Alternative 2 Community Plan Land Uses
 - 45: Total Estimated Diesel Particulate 80th Percentile Residential Incremental Cancer Risk Contours Overlain on the Alternative 1 Community Plan Land Uses
 - 46: Total Estimated Diesel Particulate 80th Percentile Residential Incremental Cancer Risk Contours Overlain on the Revised Alternative 2 Community Plan Land Uses
 - 47: Total Estimated Diesel Particulate 80th Percentile Residential Incremental Cancer Risk Contours Overlain on the Adopted Community Plan Land Uses
- 2: CalEEMod 2011 v1.1 Input and Output Files (on CD)
- 3: EMFAC2007 Output (on CD)
- 4: CALINE4 Modeling Assumptions (on CD)
- 5: CALINE4 Freeway Input and Output Files—Adopted Plan (on CD)
- 6: CALINE4 Freeway Input and Output Files—CPU Alternative 1 (on CD)
- 7: CALINE4 Freeway Input and Output Files—CPU Alternative 2 (on CD)
- 8: Freeway Diesel Particulate Matter Carcinogenic and Chronic Risk Calculations (on CD)
- 9: CALINE4 Truck Route Input and Output Files—CPU Alternative 1 (on CD)
- 10: CALINE4 Truck Route Input and Output Files—CPU Alternative 2 (on CD)
- 11: Truck Route Diesel Particulate Matter Carcinogenic and Chronic Risk Calculations (on CD)
- 12: Screen3 Output Files (on CD)
- 13: AERMOD Input and Output Files—BNSF Vehicle Train Operations (on CD)
- 14: AERMOD Input and Output Files—BNSF “Local” Train Operations (on CD)
- 15: AERMOD Input and Output Files—SDIY Train Operations (on CD)

1.0 Summary

The proposed Barrio Logan Community Plan Update (proposed CPU) area is located south of Commercial Street, north of Division Street, west of Interstate 5 (I-5), and east the Pacific coastline in the City of San Diego (City). This report evaluates potential local and regional air quality impacts by comparing the existing air pollutant emissions in the proposed CPU area to the future emissions associated with the adopted community plan and the two proposed project alternatives. This report also evaluates health risks within the community associated with heavily traveled roadways and freeways, as well as from trains in the proposed CPU area.

As discussed below, future non-attainment criteria pollutant emissions under the proposed project alternatives are projected to be greater than existing emissions and future emissions under the adopted community plan. Because emissions of non-attainment criteria pollutants would be greater than those anticipated under current regional air quality plans, impacts associated with the project alternatives are considered significant and unmitigable. In general, impacts associated with proposed CPU land use Revised Alternative 2 are less than those associated with proposed CPU land use Alternative 1.

Further—as discussed below—overall, the entire Barrio Logan community is exposed to incremental and total cancer risks greater than the significance threshold of 10 in one million due to sources located primarily outside of the Barrio Logan community boundaries. This also represents a significant impact for which no mitigation is available. The absolute cancer risks are similar for the adopted community plan and both CPU alternatives. However, because the proposed CPU alternatives designate more residential uses than does the adopted community plan, the relative cancer risk associated with the proposed CPU alternatives is generally considered to be more than that under the adopted community plan due to the larger exposed residential population.

2.0 Introduction and Project Description

The proposed project would replace the existing Barrio Logan Community Plan with updated land uses, development standards, and design guidelines. Two land use alternatives are presented as part of the proposed project. The purpose of the proposed project is to build upon the goals and strategies in the General Plan and guide the future development of the Barrio Logan community. The purpose of this report is to assess potential local and regional air quality impacts that could result from adoption of either of the proposed project alternatives.

Air pollution affects all southern Californians. Effects can include the following:

- Increased respiratory infection
- Increased discomfort
- Missed days from work and school
- Increased mortality

Polluted air also damages agriculture and our natural environment.

The Barrio Logan community is located within the San Diego Air Basin (SDAB), one of 15 air basins that geographically divide the state of California (State). The SDAB is currently classified as a federal non-attainment area for ozone and a State non-attainment area for particulate matter less than 10 microns (PM_{10}), particulate matter less than 2.5 microns ($PM_{2.5}$), and ozone.

Air quality impacts can result from the construction and operation of projects approved under the proposed CPU. Construction impacts are short-term and result from fugitive dust, equipment exhaust, and indirect effects associated with construction workers and deliveries. Operational impacts can occur on three levels: (1) regional impacts resulting from additional population and vehicle-related emissions associated with development, (2) local hot-spot effects stemming from sensitive receivers being placed close to highly congested roadways, freeways, and other localized sources of air pollutants (e.g., factories, trains, etc.), and (3) introduction of new stationary source emitters. In the case of the proposed CPU, operational impacts would be primarily due to emissions to the basin from mobile sources associated with the vehicular travel along the roadways within the proposed CPU area. Other sources of operational emissions would include stationary sources, such as fireplaces and natural gas heating.

Given that the proposed CPU is a plan, it does not in and of itself involve project construction or operation. However, its implementation would allow for the buildout of the proposed CPU area in accordance with its proposed land use designations and allowable density and mass.

The proposed CPU area is generally located south of Commercial Street and north of Division Street. I-5 defines the eastern border and San Diego Bay defines the western border. Figure 1 shows the regional location of the proposed CPU area, Figure 2 provides an aerial photograph of the proposed CPU area, and Figures 3a–c show the land uses for the adopted Community Plan and the proposed land uses for Alternative 1 and Revised Alternative 2 of the proposed CPU. All figures referenced in this report are located in Attachment 1.

Although the City does not have regulatory jurisdiction over Port Tidelands or Navy properties, portions of these lands are within the boundaries of the City and the proposed CPU area and thus are reflected on the maps. However, for the purposes of this analysis the proposed CPU area was divided into two distinct areas: (1) lands under City Regulatory Jurisdiction and (2) lands under Port/Navy Jurisdiction (Figure 4). Potential regional air quality impacts resulting from the proposed CPU were only analyzed for sources located within the proposed CPU area in which the City has regulatory jurisdiction. Further, localized impacts were only addressed for lands within the proposed CPU area under City regulatory jurisdiction.

3.0 Regulatory Framework

Motor vehicles are San Diego County's leading source of air pollution and the largest contributor to greenhouse gases (County of San Diego 2008). In addition to these sources, other mobile sources include construction equipment, trains, and airplanes. Emission standards for mobile sources are established by state and federal agencies, such as the California Air Resources Board (CARB) and the U.S. Environmental Protection Agency (EPA). Reducing mobile source emissions requires the technological improvement of existing mobile sources and the examination of future mobile sources, such as those associated with new or modification projects (e.g., retro-fitting older vehicles with cleaner emission technologies). The State of California has developed statewide programs to encourage cleaner cars and cleaner fuels. Since 1996, smog-forming emissions from motor vehicles have been reduced by 15 percent, and the cancer risk from exposure to motor vehicle air toxics has been reduced by 40 percent (County of San Diego 2008). The regulatory framework described below details the federal and State agencies that are in charge of monitoring and controlling mobile source air pollutants and the measures currently being taken to achieve and maintain healthful air quality in the SDAB.

In addition to mobile sources, stationary sources also contribute to air pollution in the SDAB. Stationary sources include gasoline stations, power plants, dry cleaners, and other commercial and industrial uses. Stationary sources of air pollution are regulated by the local air pollution control or management district, in this case the San Diego County Air Pollution Control District (APCD).

The state of California is divided geographically into 15 air basins for managing the air resources of the State on a regional basis. Areas within each air basin are considered to share the same air masses and, therefore, are expected to have similar ambient air quality.

If an air basin is not in either federal or State attainment for a particular pollutant, the basin is classified as a moderate, serious, severe, or extreme non-attainment area for that pollutant (there is also a marginal classification for federal non-attainment areas). Once a non-attainment area has achieved the air quality standards for a particular pollutant, it may

be re-designated to an attainment area for that pollutant. To be re-designated, the area must meet air quality standards and have a 10-year plan for continuing to meet and maintain air quality standards, as well as satisfy other requirements of the Clean Air Act. Areas that are re-designated to attainment are called maintenance areas.

3.1 Federal Regulations

Ambient Air Quality Standards (AAQS) represent the maximum levels of background pollution considered safe, with an adequate margin of safety, to protect the public health and welfare. The federal Clean Air Act (CAA) was enacted in 1970 and amended in 1977 and 1990 [42 United States Code (U.S.C.) 7401] for the purposes of protecting and enhancing the quality of the nation's air resources to benefit public health, welfare, and productivity. In 1971, in order to achieve the purposes of Section 109 of the CAA [42 U.S.C. 7409], the EPA developed primary and secondary national ambient air quality standards (NAAQS).

Seven criteria pollutants of primary concern have been designated: ozone (O_3), carbon monoxide (CO), sulfur dioxide (SO_2), nitrogen dioxide (NO_2), lead (Pb), and respirable particulate matter (PM_{10} and $PM_{2.5}$). The primary NAAQS "... in the judgment of the Administrator, based on such criteria and allowing an adequate margin of safety, are requisite to protect the public health . . ." and the secondary standards "... protect the public welfare from any known or anticipated adverse effects associated with the presence of such air pollutant in the ambient air" [42 U.S.C. 7409(b)(2)]. The primary NAAQS were established, with a margin of safety, considering long-term exposure for the most sensitive groups in the general population (i.e., children, senior citizens, and people with breathing difficulties). The NAAQS are presented in Table 1 (State of California 2010a).

Ozone (O_3)

In 1997, the EPA promulgated a new eight-hour ozone standard of eight parts per hundred million (pphm) to replace the existing one-hour standard of 12 pphm. On June 15, 2004, that portion of the SDAB containing the project site was designated a "basic" non-attainment area for the 1997 eight-hour ozone standard under Subpart 1 of Part D of the CAA. Per the EPA's final Phase 1 rule for implementing the 1997 eight-hour ozone standard, the one-hour ozone standard was to be revoked "in full, including the associated designations and classifications, one year following the effective date of the designations for the eight-hour NAAQS [for ozone]" (69 Federal Register [FR] 23951). As such, the one-hour ozone standard was revoked in the SDAB on June 15, 2005. Requirements for transitioning from the one-hour to eight-hour ozone standard are described in the final rule.

**TABLE 1
AMBIENT AIR QUALITY STANDARDS**

Pollutant	Averaging Time	California Standards ¹		Federal Standards ²		
		Concentration ³	Method ⁴	Primary ^{3,5}	Secondary ^{3,6}	Method ⁷
Ozone (O ₃)	1 Hour	0.09 ppm (180 µg/m ³)	Ultraviolet Photometry	–	Same as Primary Standard	Ultraviolet Photometry
	8 Hour	0.07 ppm (137 µg/m ³)		0.075 ppm (147 µg/m ³)		
Respirable Particulate Matter (PM ₁₀)	24 Hour	50 µg/m ³	Gravimetric or Beta Attenuation	150 µg/m ³	Same as Primary Standard	Inertial Separation and Gravimetric Analysis
	Annual Arithmetic Mean	20 µg/m ³		–		
Fine Particulate Matter (PM _{2.5})	24 Hour	No Separate State Standard		35 µg/m ³	Same as Primary Standard	Inertial Separation and Gravimetric Analysis
	Annual Arithmetic Mean	12 µg/m ³	Gravimetric or Beta Attenuation	15.0 µg/m ³		
Carbon Monoxide (CO)	8 Hour	9.0 ppm (10 mg/m ³)	Non-Dispersive Infrared Photometry (NDIR)	9 ppm (10 mg/m ³)	None	Non-Dispersive Infrared Photometry (NDIR)
	1 Hour	20 ppm (23 mg/m ³)		35 ppm (40 mg/m ³)		
	8 Hour (Lake Tahoe)	6 ppm (7 mg/m ³)		–		
Nitrogen Dioxide (NO ₂)	Annual Arithmetic Mean	0.030 ppm (57 µg/m ³)	Gas Phase Chemiluminescence	53 ppb ⁸ (100 µg/m ³)	Same as Primary Standard	Gas Phase Chemiluminescence
	1 Hour	0.18 ppm (339 µg/m ³)		100 ppb ⁸ (188 µg/m ³)	None	
Sulfur Dioxide (SO ₂)	24 Hour	0.04 ppm (105 µg/m ³)	Ultraviolet Fluorescence	–	–	Ultraviolet Fluorescence; Spectrophotometry (Pararosaniline Method) ⁹
	3 Hour	–		–	0.5 ppm ⁹ (1300 µg/m ³)	
	1 Hour	0.25 ppm (655 µg/m ³)		75 ppb ⁹ (196 µg/m ³)	–	
Lead ¹⁰	30 Day Average	1.5 µg/m ³	Atomic Absorption	–	–	–
	Calendar Quarter	–		1.5 µg/m ³	Same as Primary Standard	High Volume Sampler and Atomic Absorption
	Rolling 3-Month Average ¹¹	–		0.15 µg/m ³		
Visibility Reducing Particles	8 Hour	Extinction coefficient of 0.23 per kilometer—visibility of 10 miles or more (0.07–30 miles or more for Lake Tahoe) due to particles when relative humidity is less than 70 percent. Method: Beta Attenuation and Transmittance through Filter Tape.		No Federal Standards		
Sulfates	24 Hour	25 µg/m ³	Ion Chromatography			
Hydrogen Sulfide	1 Hour	0.03 ppm (42 µg/m ³)	Ultraviolet Fluorescence			
Vinyl Chloride ¹⁰	24 Hour	0.01 ppm (26 µg/m ³)	Gas Chromatography			

See notes on next page.

TABLE 1
AMBIENT AIR QUALITY STANDARDS
(continued)

SOURCE: State of California 2010a.

ppm = parts per million; ppb = parts per billion; $\mu\text{g}/\text{m}^3$ = micrograms per cubic meter; -- = not applicable.

¹ California standards for ozone, carbon monoxide (except Lake Tahoe), sulfur dioxide (1 and 24 hour), nitrogen dioxide, suspended particulate matter— PM_{10} , $\text{PM}_{2.5}$, and visibility reducing particles, are values that are not to be exceeded. All others are not to be equaled or exceeded. California ambient air quality standards are listed in the Table of Standards in Section 70200 of Title 17 of the California Code of Regulations.

² National standards (other than ozone, particulate matter, and those based on annual averages or annual arithmetic mean) are not to be exceeded more than once a year. The ozone standard is attained when the fourth highest eight hour concentration in a year, averaged over three years, is equal to or less than the standard. For PM_{10} , the 24 hour standard is attained when the expected number of days per calendar year with a 24-hour average concentration above $150 \mu\text{g}/\text{m}^3$ is equal to or less than one. For $\text{PM}_{2.5}$, the 24 hour standard is attained when 98 percent of the daily concentrations, averaged over three years, are equal to or less than the standard. Contact U.S. EPA for further clarification and current federal policies.

³ Concentration expressed first in units in which it was promulgated. Equivalent units given in parentheses are based upon a reference temperature of 25°C and a reference pressure of 760 torr. Most measurements of air quality are to be corrected to a reference temperature of 25°C and a reference pressure of 760 torr; ppm in this table refers to ppm by volume, or micromoles of pollutant per mole of gas.

⁴ Any equivalent procedure which can be shown to the satisfaction of the ARB to give equivalent results at or near the level of the air quality standard may be used.

⁵ National Primary Standards: The levels of air quality necessary, with an adequate margin of safety to protect the public health.

⁶ National Secondary Standards: The levels of air quality necessary to protect the public welfare from any known or anticipated adverse effects of a pollutant.

⁷ Reference method as described by the EPA. An "equivalent method" of measurement may be used but must have a "consistent relationship to the reference method" and must be approved by the EPA.

⁸ To attain this standard, the 3-year average of the 98th percentile of the daily maximum 1-hour average at each monitor within an area must not exceed 0.100 ppm (effective January 22, 2010). Note that the EPA standards are in units of parts per billion (ppb). California standards are in units of parts per million (ppm). To directly compare the national standards to the California standards the units can be converted from ppb to ppm. In this case, the national standards of 53 ppb and 100 ppb are identical to 0.053 ppm and 0.100 ppm, respectively.

⁹ On June 2, 2010, the U.S. EPA established a new 1-hour SO_2 standard, effective August 23, 2010, which is based on the 3-year average of the annual 99th percentile of 1-hour daily maximum concentrations. EPA also proposed a new automated Federal Reference Method (FRM) using ultraviolet technology, but will retain the older pararosaniline methods until the new FRM have adequately permeated State monitoring networks. The EPA also revoked both the existing 24-hour SO_2 standard of 0.14 ppm and the annual primary SO_2 standard of 0.030 ppm, effective August 23, 2010. The secondary SO_2 standard was not revised at that time; however, the secondary standard is undergoing a separate review by EPA. Note that the new standard is in units of parts per billion (ppb). California standards are in units of parts per million (ppm). To directly compare the new primary national standard to the California standard the units can be converted to ppm. In this case, the national standard of 75 ppb is identical to 0.075 ppm.

¹⁰ The ARB has identified lead and vinyl chloride as 'toxic air contaminants' with no threshold level of exposure for adverse health effects determined. These actions allow for the implementation of control measures at levels below the ambient concentrations specified for these pollutants.

¹¹ National lead standard, rolling 3-month average; final rule signed October 15, 2008.

However, because of subsequent litigation concerning the Phase 1 implementation rule, the provisions of the 1997 eight-hour ozone standard Phase 1 implementation rule that placed eight-hour ozone non-attainment areas under Subpart 1, Part D, Title I of the CAA instead of Subpart 2 were vacated. Consequently, on January 16, 2009, it was proposed that the SDAB be classified as “moderate” non-attainment for the 1997 eight-hour ozone standard under Subpart 2 (U.S. EPA 2009a). On May 14, 2012, the EPA issued their final designation for the SDAB. The SDAB was designated a “moderate” non-attainment area for the 1997 8-hour ozone standard under subpart 2 (77 FR 28423). Under Subpart 2, consistent with Section 182 of the CAA, the period of attainment for areas designated as moderate non-attainment will be no more than six years from the effective date of designation (U.S. EPA 2009a).

On March 12, 2008, the EPA revised the eight-hour ozone standard to 7.5 pphm. On March 12, 2009, CARB submitted its recommendations for area designations for the revised federal 2008 eight-hour ozone standard. The recommendations were based on ozone measurements collected during 2006 through 2008. It was recommended that the SDAB be classified as non-attainment for the revised standard. The EPA was required to issue final area designations no later than March 2010. However, there was insufficient information to make these designations and the EPA extended the deadline to March 2011.

Criticism of the standards proposed in March 2008 resulted in the reconsideration of those standards by the EPA. On January 16, 2010, the EPA again proposed revision of the eight-hour ozone standards. The EPA proposed to set the primary standard at a level ranging between 6 and 7 pphm. The EPA also proposed establishing a distinct cumulative, seasonal “secondary” standard, designed to protect sensitive vegetation and ecosystems, including forests, parks, wildlife refuges and wilderness areas. The EPA proposed to set the secondary standard at a level within the range of 7–15 parts per million-hours (ppm-hours).

The EPA was to issue final standards by August 31, 2010. However, on December 8, 2010, the EPA Administrator asked the Clean Air Scientific Advisory Committee (CASAC) for further interpretation of the epidemiological and clinical studies used to make their recommendation. On January 26, 2011, the EPA provided “charge questions” to the Clean Air Scientific Advisory Committee regarding the reconsideration of the 2008 ozone standards. The EPA reviewed the additional input the Clean Air Scientific Advisory Committee provided, and in July 2011 had proposed to set the final 8-hour ozone standard to 0.070 parts per million (ppm). On September 2, 2011, President Obama directed the EPA to withdraw this draft ozone NAAQS. The EPA will continue to implement the 2008 standards set during the previous administration while the ongoing five-year review of the updated science continues, which is scheduled to be completed in 2013.

As such, on April 30, 2012, the EPA provided final designations for the 2008 8-hour ozone standards. The SDAB was designated a “marginal” non-attainment area for the 2008 8-hour ozone standards (77 FR 30087). The APCD must submit a State Implementation Plan (SIP) revision outlining how the SDAB will meet the 2008 standards by December 31, 2015 (77 FR 30160).

PM₁₀ and PM_{2.5}

The SDAB is unclassified for the federal PM₁₀ standard and classified as an attainment area for the federal PM_{2.5} standard (State of California 2009). On September 21, 2006, the EPA revised the NAAQS for particulate matter. The 24-hour PM_{2.5} standard was strengthened from 65 micrograms per cubic meter (µg/m³) to 35 µg/m³. The existing standard for annual PM_{2.5} of 15 µg/m³ remained the same. The SDAB is classified as an attainment area for the new federal 24-hour PM_{2.5} standard (U.S. EPA 2009b).

The EPA also revised the standard for PM₁₀. Due to a lack of evidence linking health problems to long-term exposure to coarse particle pollution, the agency revoked the annual PM₁₀ standard (effective December 17, 2006), retaining only the existing 24-hour standard.

Sulfur Dioxide (SO₂)

The SDAB is a federal attainment area for sulfur dioxide. On June 22, 2010, the EPA established a new one-hour SO₂ standard, effective August 23, 2010 (75 FR 35519). The revised standard is based on the three-year average of the annual 99th percentile of one-hour daily maximum concentrations. The EPA also revoked both the existing 24-hour SO₂ standard of 0.14 ppm and the annual primary SO₂ standard of 0.030 ppm, effective August 23, 2010. The EPA intends to complete designations for the new standards within two years of promulgation, which would be by June 2012. Areas designated non-attainment would be required to submit SIPs within two years of designation that demonstrate how the standard would be met no later than August 2017. All other areas would be required to submit maintenance plans by June 2013.

The secondary standards for SO₂ also underwent separate review. On March 20, 2012, the EPA took final action to retain the existing secondary SO₂ standard of 0.5 ppm averaged over three hours, not to be exceeded more than once per year (77 FR 20218). The final rule for the secondary standard became effective June 4, 2012.

Nitrogen Dioxide (NO₂)

All areas of the state, including the SDAB, are either unclassified or in attainment of the federal nitrogen dioxide standards. On February 9, 2010, the EPA strengthened the one-hour NO₂ standard to 100 parts per billion (ppb) based on the three-year average of the 98th percentile of the annual distribution of daily maximum one-hour average concentrations (75 FR 6473). The annual NO₂ standard of 53 ppb remained unchanged. The EPA completed

final designations for the new standards on January 20, 2012. The EPA determined that no area of the country, including the SDAB, is violating the 2010 national standard for NO₂. As such, all areas have been designated as “unclassifiable/attainment.” To determine compliance with the standard, the new NO₂ rule also establishes a new ambient air monitoring network and reporting requirements. Once the expanded network of NO₂ monitors is fully deployed and three years of air quality data have been collected, EPA intends to redesignate areas in 2016 or 2017, as appropriate, based on the air quality data from the new monitoring network.

The secondary standards for NO₂ also underwent separate review. On March 20, 2012, the EPA took final action to retain the existing secondary NO₂ standard of 0.053 ppm averaged over a year (77 FR 20218). The final rule for the secondary standard became effective June 4, 2012.

Lead (Lb)

In 2008, the EPA revised the primary standard for lead from 1.5 micrograms per cubic meter (µg/m³) to 0.15 µg/m³ over a rolling three-month period, and revised the secondary standard to be identical to the primary standard (73 FR 66964). On November 22, 2011, the EPA finalized designations for the 2008 lead standard. Although limited portions of Los Angeles County were designated as non-attainment, all other areas within the state of California were designated as unclassifiable/attainment (76 FR 72097). The 1978 lead NAAQS was to be retained until one year after designations for the new standards, except in current non-attainment areas. The SDAB is in attainment of the 1978 lead NAAQS.

Carbon Monoxide (CO)

The CAA requires that the EPA review the standards every five years. On August 31, 2011, the EPA finalized review of the CO standards and concluded that the existing standards would be retained (76 FR 54294). All areas of California are either unclassifiable or in attainment (maintenance) for CO standards. The SDAB is a federal maintenance area for CO.

3.2 State Regulations

3.2.1 Criteria Pollutants

The EPA allows states the option to develop different (stricter) standards. The State of California has developed the California Ambient Air Quality Standards (CAAQS) and generally has set more stringent limits on the seven criteria pollutants (see Table 1). In addition to the federal criteria pollutants, the CAAQS also specify standards for visibility-reducing particles, sulfates, hydrogen sulfide, and vinyl chloride (see Table 1). The California CAA, also known as the Sher Bill or California Assembly Bill 2595 (AB 2595), was

signed into law on September 30, 1988, and became effective on January 1, 1989. The California CAA requires that districts implement regulations to reduce emissions from mobile sources through the adoption and enforcement of transportation control measures. The California CAA also requires that a district must (South Coast Air Quality Management District [SCAQMD] 2003):

- Demonstrate the overall effectiveness of the air quality program;
- Reduce non-attainment pollutants at a rate of five percent per year, or include all feasible measures and expeditious adoption schedule;
- Ensure no net increase in emissions from new or modified stationary sources;
- Reduce population exposure to severe non-attainment pollutants according to a prescribed schedule;
- Include any other feasible controls that can be implemented, or for which implementation can begin, within 10 years of adoption of the most recent air quality plan; and
- Rank control measures by cost-effectiveness.

The SDAB is a non-attainment area for the State ozone standards, the State PM₁₀ standard, and the State PM_{2.5} standard.

3.2.2 Toxic Air Contaminants

The public's exposure to toxic air contaminants (TACs) is a significant public health issue in California. In 1983, the California Legislature enacted a program to identify the health effects of TACs and to reduce exposure to these contaminants to protect the public health (AB 1807: Health and Safety Code Sections 39650–39674). The Legislature established a two-step process to address the potential health effects from TACs. The first step is the risk assessment (or identification) phase. The second step is the risk management (or control) phase of the process.

The California Air Toxics Program establishes the process for the identification and control of toxic air contaminants and includes provisions to make the public aware of significant toxic exposures and for reducing risk. Additionally, the Air Toxics "Hot Spots" Information and Assessment Act (AB 2588, 1987, Connelly Bill) was enacted in 1987 and requires stationary sources to report the types and quantities of certain substances routinely released into the air. The goals of the Air Toxics "Hot Spots" Act are to collect emission data, to identify facilities having localized impacts, to ascertain health risks, to notify nearby residents of significant risks, and to reduce those significant risks to acceptable levels. The Children's Environmental Health Protection Act, California Senate Bill (SB) 25 (Chapter 731, Escutia,

Statutes of 1999), focuses on children's exposure to air pollutants. The Act requires CARB to review its air quality standards from a children's health perspective, evaluate the statewide air monitoring network, and develop any additional air toxic control measures needed to protect children's health. Locally, toxic air pollutants are regulated through the APCD's Regulation XII.

Of particular concern statewide are diesel-exhaust particulate matter (DPM) emissions. DPM was established as a TAC in 1998 and is estimated to represent a majority of the cancer risk from TACs statewide (based on the statewide average). Diesel exhaust is a complex mixture of gases, vapors, and fine particles. This complexity makes the evaluation of health effects of diesel exhaust a complex scientific issue. Some of the chemicals in diesel exhaust, such as benzene and formaldehyde, have been previously identified as TACs by the CARB and are listed as carcinogens either under the State's Proposition 65 or under the federal Hazardous Air Pollutants program. Diesel emissions generated within the Barrio Logan community and the surrounding areas pose a potential hazard to residents and visitors.

Following the identification of diesel particulate matter as a TAC in 1998, CARB has worked on developing strategies and regulations aimed at reducing the risk from diesel particulate matter. The overall strategy for achieving these reductions is found in the *Risk Reduction Plan to Reduce Particulate Matter Emissions from Diesel-Fueled Engines and Vehicles* (State of California 2000). A stated goal of the plan is to reduce the cancer risk statewide arising from exposure to diesel particulate matter 85 percent by 2020.

A number of programs and strategies to reduce diesel particulate matter that have been implemented or are in the process of being developed include (State of California 2010b):

- **The Carl Moyer Memorial Air Quality Standards Attainment Program:** This program, administered by CARB, was initially approved in February 1999 and provides incentive grants to cover an incremental portion of the cost of upgrading to cleaner-than-required engines, equipment and other sources of pollution providing early or extra emission reductions. Eligible projects include cleaner on-road, off-road, marine, locomotive, and agricultural sources. The program guidelines are revised regularly (most recently in April 2011).
- **On-road Heavy-duty Diesel Engine Reduced Emission Standards:** This rule reduces emission standards for 2007 and subsequent model year heavy-duty diesel engines (66 FR 5002, January 18, 2001).
- **On-road Heavy-duty Diesel Engine In-use Compliance Program:** This program requires in-use compliance testing to ensure that existing vehicles/engines meet applicable emission standards throughout their useful life.

Other programs include:

- **Off-road Mobile Sources Emission Reduction Program:** The goal of this program is to develop regulations to control emissions from diesel, gasoline, and alternative-fueled off-road mobile engines. These sources include a range of equipment, from lawn mowers to construction equipment to locomotives.
- **Heavy-duty Vehicle Inspection Program:** The Heavy-duty Vehicle Inspection and Periodic Smoke Inspection Programs were established to control excessive smoke emissions and tampering from heavy-duty diesel trucks and buses.
 - **Heavy-duty Vehicle Inspection Program:** The Heavy-duty Vehicle Inspection Program was adopted into law in 1988 (SB 1997), with the regulations (13 California Code of Regulations [CCR] 2180–2189) governing this program last amended in 2007. The program requires heavy-duty trucks and buses to be inspected for excessive smoke and tampering, and engine certification label compliance. Any heavy-duty vehicle traveling in California, including vehicles registered in other states and foreign countries, may be tested. Tests are performed by CARB inspection teams at border crossings, California Highway Patrol weigh stations, fleet facilities, and randomly selected roadside locations.
 - **Periodic Smoke Inspection Program:** The Periodic Smoke Inspection Program was adopted into law in 1990 (SB 2330), with the regulations (13 CCR 2190–2194) governing this program last amended in 2007. The program requires that diesel and bus fleet owners conduct annual smoke opacity inspections of their vehicles and repair those with excessive smoke emissions to ensure compliance.
- **Lower-emission School Bus Program:** Under this program, and in coordination with the California Energy Commission and local air districts, CARB developed guidelines to provide criteria for the purchase of new school buses and the retrofit of existing school buses to reduce particulate matter emissions. In addition, Proposition 1B, which was approved by the voters on November 7th, 2006, enacts the Highway Safety, Traffic Reduction, Air Quality, and Port Security Bond Act of 2006. This bond act authorizes \$200 million for replacing and retrofitting school buses.
- **School Bus Idling Airborne Toxic Control Measure:** Beginning in July 2003, the CARB approved an airborne toxic control measure (ATCM) that limits school bus idling and idling at or near schools. The ATCM to limit idling is intended to reduce diesel exhaust particulate matter and other TACs and air pollutants from heavy-duty motor vehicle exhaust. The ATCM requires a driver of a school bus or vehicle, transit bus, or other commercial motor vehicle to manually turn off the bus or vehicle engine upon arriving at a school and to restart no more than 30 seconds before departing. A driver of a school bus or vehicle is subject to the same requirement when operating within 100 feet of a school and is prohibited from idling more than five minutes at

each stop beyond schools, such as parking or maintenance facilities, school bus stops, or school activity destinations. A driver of a transit bus or other commercial motor vehicle is prohibited from idling more than five minutes at each stop within 100 feet of a school. Idling necessary for health, safety, or operational concerns is exempt from these restrictions.

In April 2005, CARB published *Air Quality and Land Use Handbook: A Community Health Perspective* (State of California 2005). The handbook makes recommendations directed at protecting sensitive land uses from air pollutant emissions while balancing a myriad of other land use issues (e.g., housing, transportation needs, economics, etc.). It notes that the handbook is not regulatory or binding on local agencies and recognizes that application takes a qualitative approach. As reflected in the CARB Handbook, there is currently no adopted standard for the significance of health effects from mobile sources. Therefore, the CARB has provided guidelines for the siting of land uses near heavily traveled roadways. Of pertinence to this study, the CARB guidelines indicate that siting new sensitive land uses within 500 feet of a freeway or urban roads with 100,000 or more vehicles/day should be avoided when possible.

As an ongoing process, CARB will continue to establish new programs and regulations for the control of diesel-particulate and other air-toxics emissions as appropriate. The continued development and implementation of these programs and policies will ensure that the public's exposure to diesel particulate matter will continue to decline.

As discussed below, the APCD implements rules and regulations for the control of toxic air contaminants through permitting of stationary and portable sources of air pollutants.

Numerous activities have also occurred at the federal level, including:

- In 2006 the EPA adopted low-sulfur fuel standards that are anticipated to significantly reduce diesel emissions.
- In January 2011, President Obama signed the Diesel Emission Reduction Act (DERA) of 2010 (HR 5809), which reauthorizes DERA for another five years. DERA was originally created in 2005 and provides grants to state, local, and tribal governments for programs to reduce emissions from existing diesel engines. This legislation authorizes \$100 million annually for five years, for a total of \$500 million, although the actual annual amount will depend on each year's funding appropriation. According to EPA, every \$1 spent on DERA upgrades has resulted in \$13 worth of health and environmental benefits (West Coast Collaborative 2011).

3.2.3 Children’s Environmental Health Protection Act

The Children’s Environmental Health Protection Act (SB 25, Escutia 1999) established specific requirements to determine if children are adequately protected from the harmful effects of air pollution. The act requires the CARB and the Office of Environmental Health Hazard Assessment to review all health-based California AAQS to determine if public health, particularly the health of infants and children, is adequately protected. It also requires a review of the air monitoring network to determine if it accurately measures the amount of pollutants in the air. Furthermore, the State’s list of TACs must be reviewed, and Air Toxic Control Measures must be implemented, in order to reduce exposure to TACs that cause children to be especially susceptible to illness.

Of particular interest to this study, as described in Section 4.5.1 below, Senate Bill 25 required that the CARB expand the existing monitoring program in six communities around the state and conduct special monitoring. Locations were selected where children are typically present, such as schools and daycare centers, and near sources of air pollution, including busy highways and industry. One of the six communities selected for this monitoring was the Barrio Logan Community.

3.3 State Implementation Plan

The SIP is a collection of documents that set forth the State’s strategies for achieving the NAAQS. In California, the SIP is a compilation of new and previously submitted plans, programs (such as monitoring, modeling, permitting, etc.), district rules, State regulations, and federal controls. The CARB is the lead agency for all purposes related to the SIP under State law. Local air districts and other agencies, such as the Department of Pesticide Regulation and the Bureau of Automotive Repair, prepare SIP elements and submit them to CARB for review and approval. The CARB then forwards SIP revisions to the EPA for approval and publication in the Federal Register. All of the items included in the California SIP are listed in the Code of Federal Regulations (CFR) at 40 CFR 52.220.

The APCD is responsible for preparing and implementing the portion of the SIP applicable to the SDAB. The APCD adopts rules, regulations, and programs to attain State and federal air quality standards, and appropriates money (including permit fees) to achieve these objectives.

3.4 The California Environmental Quality Act

Section 15125(d) of the California Environmental Quality Act (CEQA) Guidelines requires discussion of any inconsistencies between the proposed project and applicable general plans and regional plans, including the applicable air quality attainment or maintenance plan (or SIP).

3.5 Regional Air Quality Strategy

The APCD is the agency that regulates air quality in the SDAB. The APCD prepared the 1991/1992 Regional Air Quality Strategy (RAQS) in response to the requirements set forth in AB 2595. The draft was adopted, with amendments, on June 30, 1992 (County of San Diego 1992). Attached, as part of the RAQS, are the Transportation Control Measures (TCMs) for the air quality plan prepared by the San Diego Association of Governments (SANDAG) in accordance with AB 2595 and adopted by SANDAG on March 27, 1992, as Resolution Number 92-49 and Addendum. The required triennial updates of the RAQS and corresponding TCMs were adopted in 1995, 1998, 2001, 2004, and 2009. The RAQS and TCMs set forth the steps needed to accomplish attainment of the CAAQS.

4.0 Environmental Setting

4.1 Geographic Setting

The proposed CPU area is located in the SDAB adjacent to San Diego Bay and 2 to 3 miles east of the Pacific Ocean. The eastern portion of the SDAB is surrounded by mountains to the north, east, and south. These mountains tend to restrict airflow and concentrate pollutants in the valleys and low-lying areas below.

4.2 Climate

The proposed CPU area has a Mediterranean climate characterized by warm, dry summers and mild, wet winters. The mean annual temperature for the proposed CPU area is 63 degrees Fahrenheit (°F). The average annual precipitation is approximately 10 inches, falling primarily from November to April. Winter low temperatures in the proposed CPU area average about 49°F, and summer high temperatures average about 74°F (Western Regional Climate Center 2011).

The dominant meteorological feature affecting the region is the Pacific High Pressure Zone, which produces the prevailing westerly to northwesterly winds. These winds tend to blow pollutants away from the coast toward the inland areas. Consequently, air quality near the coast is generally better than that which occurs at the base of the coastal mountain range.

Fluctuations in the strength and pattern of winds from the Pacific High Pressure Zone interacting with the daily local cycle produce periodic temperature inversions that influence the dispersal or containment of air pollutants in the SDAB. Beneath the inversion layer, pollutants become “trapped” as their ability to disperse diminishes. The mixing depth is the area under the inversion layer. Generally, the morning inversion layer is lower than the

afternoon inversion layer. The greater the change between the morning and afternoon mixing depths, the greater the ability of the atmosphere to disperse pollutants.

Throughout the year, the height of the temperature inversion in the afternoon varies between approximately 1,500 and 2,500 feet above mean sea level (MSL). In winter, the morning inversion layer is about 800 feet above MSL. In summer, the morning inversion layer is about 1,100 feet above MSL. Therefore, air quality generally tends to be better in winter than in summer. The elevation of the proposed CPU area varies between approximately sea level and 75 feet above MSL.

The prevailing westerly wind pattern is sometimes interrupted by regional “Santa Ana” conditions. A Santa Ana occurs when a strong high pressure develops over the Nevada-Utah area and overcomes the prevailing westerly coastal winds, sending strong, steady, hot, dry northeasterly winds over the mountains and out to sea.

Strong Santa Ana winds tend to blow pollutants out over the ocean, producing clear days. However, at the onset or during breakdown of these conditions, or if the Santa Ana is weak, local air quality may be adversely affected. In these cases, emissions from the South Coast Air Basin (SCAB) to the north blow out over the ocean and low pressure over Baja California, Mexico draws this pollutant-laden air mass southward. As the high pressure weakens, prevailing northwesterly winds reassert themselves and send this cloud of contamination ashore in the SDAB. When this event does occur, the combination of transported and locally produced contaminants produce the worst air quality measurements recorded in the basin.

4.3 Existing Air Quality—Criteria Pollutants

Air quality at a particular location is a function of the kinds, amounts, and dispersal rates of pollutants being emitted into the air locally and throughout the basin. The major factors affecting pollutant dispersion are wind speed and direction, the vertical dispersion of pollutants (which is affected by inversions), and the local topography.

Air quality is commonly expressed as the number of days in which air pollution levels exceed State standards set by the CARB or federal standards set by the EPA. The APCD currently maintains 10 air quality monitoring stations throughout the greater San Diego metropolitan region. Air pollutant concentrations and meteorological information are continuously recorded at these 10 stations. Measurements are then used by scientists to help forecast daily air pollution levels. The San Diego–1110 Beardsley Street monitoring station is located within the project boundary (Figure 5). The monitoring station is less than ¼ mile southwest of I-5. It is also less than ¼ mile northeast of the San Diego Metropolitan Transit System (SDMTS) Trolley line and less than ½ mile east of the Port of San Diego 10th Avenue Marine Terminal and other port operations. In addition, the SDMTS Barrio Logan Trolley Station is approximately ¼ mile south of the San Diego–1110 Beardsley Street monitoring station.

The San Diego–1110 Beardsley Street monitoring station started taking measurements on July 14, 2005 and monitors the following criteria pollutants: O₃, CO, PM₁₀, PM_{2.5}, NO₂, and SO₂.

Table 2 summarizes the number of days per year during which State and federal standards were exceeded in the SDAB overall during the years 2007 to 2011.

Table 3 provides a summary of measurements of O₃, CO, SO₂, NO₂, PM₁₀, and PM_{2.5} collected at the San Diego–1110 Beardsley Street monitoring station for the years 2007 through 2011. Lead is not monitored at this station.

4.3.1 Ozone

Nitrogen oxides and hydrocarbons (reactive organic gases [ROGs]) are known as the chief “precursors” of ozone. These compounds react in the presence of sunlight to produce ozone. Ozone is the primary air pollution problem in the SDAB. Because sunlight plays such an important role in its formation, ozone pollution, or smog, is mainly a concern during the daytime in summer months. The SDAB is currently designated a federal and State non-attainment area for ozone. During the past 20 years, San Diego has experienced a decline in the number of days with unhealthy levels of ozone despite the region’s growth in population and vehicle miles traveled (County of San Diego 2010b).

Locally, about three-quarters of smog-forming emissions come from motor vehicles and mobile equipment powered by internal combustion engines (County of San Diego 2009). Population growth in San Diego has resulted in a large increase in the number of automobiles expelling ozone-forming pollutants while operating on area roadways. In addition, the occasional transport of smog-filled air from the SCAB only adds to the SDAB’s ozone problem. More strict automobile emission controls, including more efficient automobile engines, have played a large role in why ozone levels have steadily decreased.

In the SDAB overall, during the five-year period of 2007 to 2011 the former national one-hour ozone standard of 0.12 ppm was exceeded one day in 2007 and two days in 2008. The stricter State one-hour ozone standard of 0.09 ppm was exceeded 21 days in 2007, 18 days in 2008, 8 days in 2009, 7 days in 2010, and 5 days in 2011 (see Table 2).

Neither the former national one-hour ozone standard of 0.12 ppm, nor the State one-hour ozone standard were exceeded at the San Diego–1110 Beardsley Street monitoring station during the five-year period of 2007 to 2011 (see Table 3).

In order to address adverse health effects due to prolonged exposure, the EPA phased out the national one-hour ozone standard and replaced it with the more protective eight-hour ozone standard. The SDAB is currently a non-attainment area for the previous (1997) national eight-hour standard and is recommended as a non-attainment area for the revised (2008) national eight-hour standard of 0.075 ppm.

**TABLE 2
AMBIENT AIR QUALITY SUMMARY—SAN DIEGO AIR BASIN**

Pollutant	Average Time	California Ambient Air Quality Standards ^a	Attainment Status	National Ambient Air Quality Standards ^b	Attainment Status ^c	Maximum Concentration					Number of Days Exceeding State Standard					Number of Days Exceeding National Standard				
						2007	2008	2009	2010	2011	2007	2008	2009	2010	2011	2007	2008	2009	2010	2011
O ₃	1 hour	0.09 ppm	N	N/A	N/A	0.134	0.139	0.119	0.107	0.114	21	18	8	7	5	1	2	0	0	0
O ₃	8 hours	0.07ppm	N	0.08 ppm (1997)	N	0.092	0.110	0.098	0.088	0.093	50	69	47	21	33	7	11	4	1	3
O ₃	8 hours	---	---	0.075 ppm (2008)	N	0.092	0.109	0.097	0.088	0.093	---	---	---	--	--	27	35	24	14	10
CO	1 hour	20 ppm	A	35 ppm	A	8.7	4.6	Na	Na	Na	0	0	Na	Na	Na	0	0	Na	Na	Na
CO	8 hours	9 ppm	A	9 ppm	A	5.18	3.51	3.54	2.46	2.44	0	0	0	0	0	0	0	0	0	0
NO ₂	1 hour	0.18 ppm	A	N/A	N/A	0.101	0.123	0.091	0.091	0.1	0	0	0	0	0	N/A	N/A	N/A	N/A	N/A
NO ₂	Annual	0.030 ppm	N/A	0.053 ppm	A	0.015	0.015	0.016	0.013	0.013	N/A	N/A	N/A	N/A	N/A	NX	NX	NX	NX	NX
SO ₂	1 hour	25 pphm	A	N/A	N/A	2.7	1.9	Na	Na	Na	0	0	Na	Na	Na	N/A	N/A	N/A	N/A	N/A
SO ₂	3 hour	---	N/A	50 pphm ^d	A	1.7	1.4	Na	Na	Na	N/A	N/A	N/A	N/A	N/A	0	0	Na	Na	Na
SO ₂	24 hours	4 pphm	A	14 pphm	A	0.9	0.7	Na	Na	Na	0	0	Na	Na	Na	0	0	Na	Na	Na
SO ₂	Annual	N/A	N/A	3 pphm	A	0.3	0.2	Na	Na	Na	N/A	N/A	N/A	N/A	N/A	NX	NX	Na	Na	Na
PM ₁₀	24 hours	50 µg/m ³	N	150 µg/m ³	U	394	158	126	108	125	27/158.6*	30/163.4*	25/146.4*	22/136*	23/138.5*	1/6.1*	1/Na*	0/Na*	0/0*	0/0*
PM ₁₀	Annual	20 µg/m ³	N	N/A	N/A	58.4	56.1	53.9	47	46.2	EX	EX	EX	EX	EX	N/A	N/A	N/A	N/A	N/A
PM _{2.5}	24 hours	N/A	N/A	35 µg/m ³	A	151	44	78.4	52.2	35.5	N/A	N/A	N/A	N/A	N/A	17/11.4	5/3.5	4/3.4	2/2	3/3
PM _{2.5}	Annual	12 µg/m ³	N	15 µg/m ³	A	13.3	14.9	12.2	10.8	10.9	EX	EX	EX	EX	EX	NX	NX	NX	NX	NX

SOURCE: State of California 2011a; U.S. EPA 2011a

*Measured Days/Calculated Days—Calculated days are the estimated number of days that a measurement would have been greater than the level of the standard had measurements been collected every day. Particulate measurements are collected every six days. The number of days above the standard is not necessarily the number of violations of the standard for the year.

^aCalifornia standards for ozone, carbon monoxide (except at Lake Tahoe), sulfur dioxide (1-hour and 24-hour), nitrogen dioxide, and PM₁₀ are values that are not to be exceeded. Some measurements gathered for pollutants with air quality standards that are based upon 1-hour, 8-hour, or 24-hour averages, may be excluded if the CARB determines they would occur less than once per year on average.

^bNational standards other than for ozone and particulates, and those based on annual averages or annual arithmetic means are not to be exceeded more than once a year. The 1-hour ozone standard is attained if, during the most recent 3-year period, the average number of days per year with maximum hourly concentrations above the standard is equal to or less than one.

^cA = attainment; N = non-attainment; U = Unclassifiable

N/A = not applicable; Na = data not available; NX = annual average not exceeded; EX = annual average exceeded.

ppm = parts per million, pphm = parts per hundred million, µg/m³ = micrograms per cubic meter.

^dSecondary Standard

TABLE 3
SUMMARY OF AIR QUALITY MEASUREMENTS
RECORDED AT THE SAN DIEGO-1110 BEARDSLEY STREET MONITORING STATION

Pollutant/Standard	2007	2008	2009	2010	2011
Ozone					
Days State 1-hour Standard Exceeded (0.09 ppm)	0	0	0	0	0
Days Federal 1-hour Standard Exceeded (0.12 ppm) ^a	0	0	0	0	0
Days Federal 8-hour Standard Exceeded (0.075 ppm)	0	0	0	0	0
Days State 8-hour Standard Exceeded (0.07 ppm)	1	1	0	0	0
Max. 1-hr (ppm)	0.087	0.087	0.085	0.078	0.082
Max. 8-hr (ppm)	0.073	0.073	0.063	0.066	0.061
Carbon Monoxide					
Days State 8-hour Standard Exceeded (20 ppm)	0	0	0	0	0
Days Federal 8-hour Standard Exceeded (35 ppm)	0	0	0	0	0
Max. 1-hr (ppm)	4.4	3.1	NA	NA	NA
Max. 8-hr (ppm)	3.01	2.60	2.77	2.17	2.44
Nitrogen Dioxide					
Days State 1-hour Standard Exceeded (0.18 ppm)	0	0	0	0	0
Max 1-hr (ppm)	0.098	0.091	0.078	0.077	0.067
Annual Average (ppm)	0.018	0.019	0.017	0.015	0.014
Sulfur Dioxide					
Days State 24-hour Standard Exceeded (0.04 ppm)	0	0	0	0	0
Max 24-hr (ppm)	0.006	0.007	0.006	0.002	0.003
Annual Average (ppm)	0.002	0.003	0.001	0.000	NA
PM₁₀					
Days State 24-hour Standard Exceeded (50 µg/m ³)*	24.4	23.6	18.2	0	0
Days Federal 24-hour Standard Exceeded (150 µg/m ³)	0	0	0	0	0
Max. Daily—Federal (µg/m ³)	110.0	58.0	59.0	40.0	48.0
Max. Daily—State (µg/m ³)	111.0	59.0	60.0	40.0	49.0
State Annual Average (µg/m ³)	31.2	29.3	29.4	23.4	24.0
Federal Annual Average (µg/m ³)	30.5	28.6	28.8	22.8	23.3
PM_{2.5}					
Days Federal 24-hour Standard Exceeded (35 µg/m ³)*	8.9	3.5	3.4	0	0
Max. Daily—Federal (µg/m ³)	69.6	42.0	52.1	29.7	34.7
Max. Daily—State (µg/m ³)	71.4	42.0	52.1	31.0	35.5
State Annual Average (µg/m ³)	11.7	10.7	11.8	NA	10.9
Federal Annual Average (µg/m ³)	12.7	13.7	11.7	10.4	10.8

SOURCE: State of California 2011a; U.S. EPA 2011a

NA = Not available.

^aThe federal 1-hour standard for ozone (0.12 ppm) has been revoked.

^bDid not exceed the previous standard of 65 µg/m³ but would have exceed the new 2006 standard of 35 µg/m³.

*Calculated days. Calculated days are the estimated number of days that a measurement would have been greater than the level of the standard had measurements been collected every day. Particulate measurements are collected every six days. The number of days above the standard is not necessarily the number of violations of the standard for the year.

In the SDAB overall, during the five-year period of 2007 to 2011 the former national eight-hour ozone standard of 0.08 ppm was exceeded 7 days in 2007, 11 days in 2008, 4 days in 2009, 1 days in 2010, and 3 days in 2011. The revised national eight-hour standard of 0.075 was exceeded 27 days in 2007, 35 days in 2008, 24 days in 2009, 14 days in 2010, and 10 days in 2011. The stricter State eight-hour ozone standard of 0.07 ppm was exceeded 50 days in 2007, 69 days in 2008, 47 days in 2009, 21 days in 2010, and 33 days in 2011.

Neither the 1997 national eight-hour standard of 0.08 ppm nor the revised 2008 national eight-hour standard of 0.075 ppm were exceeded at the San Diego–1110 Beardsley Street monitoring station. However, at the San Diego–1110 Beardsley Street monitoring station the State standard of 0.07 ppm was exceeded 1 day in 2007 and 1 day in 2008.

As mentioned, not all of the ozone within the SDAB is derived from local sources. Under certain meteorological conditions, such as during Santa Ana wind events, ozone and other pollutants are transported from the SCAB and combine with ozone formed from local emission sources to produce elevated ozone levels in the SDAB.

Local agencies can control neither the source nor the transportation of pollutants from outside the air basin. The APCD's policy, therefore, has been to control local sources effectively enough to reduce locally produced contamination to clean air standards. Using air pollution control measures outlined in the RAQS, the APCD has effectively reduced ozone levels in the SDAB.

Actions that have been taken in the SDAB to reduce ozone concentrations include:

- **TCMs if vehicle travel and emissions exceed attainment demonstration levels.** The TCMs are strategies that will reduce transportation-related emissions by reducing vehicle use or improving traffic flow.
- **Enhanced motor vehicle inspection and maintenance program.** The smog check program is overseen by the Bureau of Automotive Repair. The program requires most vehicles to pass a smog test once every two years before registering in the state of California. The smog check program monitors the amount of pollutants automobiles produce. One focus of the program is identifying "gross polluters," or vehicles that exceed two times the allowable emissions for a particular model. Regular maintenance and tune-ups, changing the oil, and checking tire inflation can improve gas mileage and lower air pollutant emissions. It can also reduce traffic congestion due to preventable breakdowns, further lowering emissions.

- **Clean-fuel vehicle program.** The clean-fuel vehicle program, overseen by CARB, requires the development of cleaner burning cars and clean alternative fuels by requiring the motor vehicle industry to develop new technologies to meet air quality requirements. Clean-fuel vehicles are those that meet the emissions standards set in the 1990 amendments to the CAA. Cleaner vehicles and fuels will result in continued reductions in vehicle pollutant emissions despite increases in travel.

4.3.2 Carbon Monoxide

The SDAB is classified as a State attainment area and as a federal maintenance area for CO (County of San Diego 1998). Until 2003, no violations of the State standard for CO had been recorded in the SDAB since 1991, and no violations of the national standard had been recorded in the SDAB since 1989. The violations that took place in 2003 were likely the result of massive wildfires that occurred throughout San Diego County. No violations of the State or federal CO standards have occurred since 2003.

Small-scale localized concentrations of CO above the state and national standards have the potential to occur at intersections with stagnation points, such as those that occur on major highways and heavily traveled and congested roadways. Localized high concentrations of CO are referred to as “CO hot spots” and are a concern at congested intersections when automobile engines burn fuel less efficiently and their exhaust contains more CO.

4.3.3 PM₁₀

PM₁₀ is particulate matter with an aerodynamic diameter of 10 microns or less. Ten microns is about one-seventh of the diameter of a human hair. Particulate matter is a complex mixture of very tiny solid or liquid particles composed of chemicals, soot, and dust. Sources of PM₁₀ emissions in the SDAB consist mainly of urban activities, dust suspended by vehicle traffic, and secondary aerosols formed by reactions in the atmosphere.

Under typical conditions (e.g., no wildfires) particles classified under the PM₁₀ category are mainly emitted directly from activities that disturb the soil, including travel on roads and construction, mining, or agricultural operations. Other sources include windblown dust, salts, brake dust, and tire wear (County of San Diego 1998). For several reasons hinging on the area’s dry climate and coastal location, the SDAB has special difficulty in developing adequate tactics to meet present State particulate standards.

The SDAB is designated as federal unclassified and State non-attainment for PM₁₀. The measured federal PM₁₀ standard was exceeded once in 2007 and once in 2008 in the SDAB. The 2007 exceedance occurred on October 21, 2007, at a time when major wildfires were raging throughout San Diego County. Consequently, this exceedance was likely caused by the wildfires and would be beyond the control of the APCD (State of California 2010c). As such, this event is covered under the EPA’s Natural Events Policy that permits,

under certain circumstances, the exclusion of air quality data attributable to uncontrollable natural events (e.g., volcanic activity, wild land fires, and high wind events). The 2008 exceedance did not occur during wildfires and is not covered under this policy. The stricter State standard was exceeded a calculated number of days of 158.6 days in 2007, 163.4 days in 2008, 146.4 days in 2009, 136 days in 2010, and 138.5 days in 2011. Calculated days are the estimated number of days that a measurement would have been greater than the level of the standard had measurements been collected every day. Particulate measurements are collected every six days.

At the San Diego–1110 Beardsley Street monitoring station, the national 24-hour PM_{10} standard was not exceeded from 2007 through 2011. The stricter State 24-hour PM_{10} standard was exceeded 4 times in 2007, 4 times in 2008, and 3 times in 2009 0 times in 2010, and 0 times in 2011 (State of California 2011a). These exceedances result in a calculated number of days that the State standard was exceeded of approximately 24.4 days, 23.6, 18.2, 0, and 0 days for 2007, 2008, 2009, 2010, and 2011 respectively.

4.3.4 $PM_{2.5}$

Airborne, inhalable particles with aerodynamic diameters of 2.5 microns or less ($PM_{2.5}$) have been recognized as an air quality concern requiring regular monitoring. Federal regulations required that $PM_{2.5}$ monitoring begin January 1, 1999 (County of San Diego 1999). The San Diego–1110 Beardsley Street monitoring station is one of five stations in the SDAB that monitors $PM_{2.5}$. Federal $PM_{2.5}$ standards established in 1997 include an annual arithmetic mean of $15 \mu\text{g}/\text{m}^3$ and a 24-hour concentration of $65 \mu\text{g}/\text{m}^3$. As discussed above, the 24-hour $PM_{2.5}$ standard has been changed to $35 \mu\text{g}/\text{m}^3$. However, this does not apply to the monitoring from 2004 to 2006. State $PM_{2.5}$ standards established in 2002 are an annual arithmetic mean of $12 \mu\text{g}/\text{m}^3$.

The SDAB was classified as an attainment area for the previous federal 24-hour $PM_{2.5}$ standard of $65 \mu\text{g}/\text{m}^3$ and has been classified as an attainment area for the revised federal 24-hour $PM_{2.5}$ standard of $35 \mu\text{g}/\text{m}^3$ (U.S. EPA 2004a, 2009b). The SDAB is a non-attainment area for the State $PM_{2.5}$ standard (State of California 2009).

In the SDAB overall the new national standard of $35 \mu\text{g}/\text{m}^3$ was exceeded a calculated number of days of 11.4 days in 2007, 3.5 days in 2008, 3.4 days in 2009, 2 days in 2010, and 3 days in 2011. Additionally, although the federal annual standard was not exceeded during the period from 2007 through 2011, the State annual standard was routinely exceeded during this period in the SDAB overall.

The prior 24-hour PM_{2.5} standard of 65 µg/m³ was not exceeded and the new standard of 35 µg/m³ was exceeded a calculated 8.9 days in 2007, 3.5 days in 2008, 3.4 days in 2009, 0 days in 2010, and 0 days in 2011. at the San Diego–1110 Beardsley Street monitoring station. As with the SDAB overall, the federal annual standard was not exceeded during the period from 2007 through 2011, whereas the State annual standard was routinely exceeded during this period at the San Diego–1110 Beardsley Street monitoring station.

4.3.5 Nitrogen Dioxide, Sulfur Dioxide, Lead, and Other Criteria Pollutants

The national and State standards for NO₂, SO₂, and previous standard for lead are being met in the SDAB, and the latest pollutant trends suggest that these standards will not be exceeded in the foreseeable future. As discussed above, new standards for these pollutants have been adopted and new designations for the SDAB will be determined in the future. The SDAB is also in attainment of the State standards for hydrogen sulfides, sulfates, and visibility-reducing particles.

4.4 Regional Background Toxic Air Pollutants

The APCD samples for toxic air contaminants at the El Cajon and Chula Vista monitoring stations. Excluding diesel particulate emissions, data from these stations indicate that the background cancer risk in 2008 due to air toxics was 135 in one million in Chula Vista and 150 in one million in El Cajon. There is no current methodology for directly measuring diesel particulate concentrations. Based on CARB estimates, diesel particulate emissions could add an additional 420 in one million to the ambient cancer risk levels in San Diego County (County of San Diego 2010c).

Thus the combined background ambient cancer risk due to air toxics in the urbanized areas of San Diego County could potentially range from around 555 to 570 in one million. As such, the air toxic of primary concern on a regional basis is diesel particulate matter.

4.5 Previous Air Quality Monitoring Studies in the Barrio Logan Area

4.5.1 CARB Barrio Logan Studies

As mentioned in Section 3.2.3, SB 25 required that the CARB expand the existing air monitoring program in six communities around the state and conduct special monitoring. In order to develop assessment tools to evaluate and understand criteria and toxic air pollutant impacts in California communities affected by multiple emission sources, CARB established

the Neighborhood Assessment Program (NAP). In 1999, Barrio Logan was chosen as the community to begin the CARB's NAP.

There were three air monitoring efforts conducted in Barrio Logan and all three studies were summarized in one report (State of California 2004a). The individual studies were:

- Air Quality at the Memorial Academy Charter School in Barrio Logan, a Neighborhood Community in San Diego (State of California 2002);
- Ambient Air Monitoring for Hexavalent Chromium and Metals in Barrio Logan: May 2001 through May 2002 (State of California 2003a); and
- Measurement of Toxic Air Pollutants for Neighborhood Assessment: Final Report for Barrio Logan Measurement Study (University of California Riverside 2003).

These studies are discussed further in the sections below.

4.5.1.1 Air Quality at the Memorial Academy Charter School

Ambient air quality measurements were made at the Memorial Academy Charter School (Memorial Academy) located near the proposed CPU area (see Figure 5). The Memorial Academy study was conducted from October 1999 through February 2001. The site was selected partly due to its proximity to potential emission sources including a major freeway and industrial sources such as shipyards. Results of the air quality monitoring at Memorial Academy were compared to three long-term APCD air monitoring stations: Chula Vista, El Cajon–Redwood Avenue, and San Diego–12th Avenue⁹. Toxic air pollutants are measured routinely at Chula Vista and El Cajon. Criteria pollutants are measured at all three sites. Table 4 provides the results of measurements taken from October 1999 to September 2000.

⁹ In 2005 the San Diego–12th Avenue monitoring station was moved to Beardsley Street and is now the San Diego–1110 Beardsley Street monitoring station.

**TABLE 4
POLLUTANTS MEASURED AT MEMORIAL ACADEMY IN A 12-MONTH PERIOD**

	Pollutant	Location			
		Memorial Academy	Chula Vista	El Cajon	San Diego–12th Ave.
PM ₁₀ ^a	Average ¹	35	31	32	35
	Maximum ¹	61	59	60	64
	Number of Days Above State Standard ²	6 of 46 days	2 of 55 days	3 of 58 days	7 of 57 days
Ozone ^b	Average ³	42	50	49	43
	Maximum ³	96	91	106	118
	Number of Days Above State Standard ⁴	1	0	5	1
NO _x ^c	Average ^{5,6}	61	31	43	54
	Maximum ^{5,6}	234	137	184	276
CO ^d	Average ⁷	1	0.9	Not Monitored	1.2
	Maximum ⁷	2.7	2.1	Not Monitored	4.1
	Number of Days Above State Standard ⁸	0	0	Not Monitored	0

Sources: State of California 2004a—^aTable 2.1, ^bTable 2.2, ^cTable 2.3, ^dTable 2.4

¹ Units of measure are micro-grams per cubic meter ($\mu\text{g}/\text{m}^3$) for 24 hours.

² State PM₁₀ standard is 50 $\mu\text{g}/\text{m}^3$.

³ Units of measure are parts-per-billion (ppb) for one-hour averages. Average and maximum are based on daily one-hour maximum values.

⁴ State ozone standard is 90 ppb for one-hour average.

⁵ Units of measure are parts-per-billion (ppb) for one-hour averages. Average and maximum are based on daily one-hour maximum values.

⁶ No State or federal standards have been established for oxides of nitrogen; the State standard for NO₂ is 250 ppb for a one-hour average; the federal annual average standard for NO₂ is 53 ppb.

⁷ Units of measure are ppm. The State standard and the daily maximum values are determined for an 8-hour average.

⁸ State CO standard is 9 ppm for an 8-hour average.

The PM₁₀ results indicate that about one out of eight days measured at Memorial Academy were higher than the State standard of 50 $\mu\text{g}/\text{m}^3$. Levels were higher than the State standard in about one out of 30 days measured at Chula Vista, and in about one out of 20 measured at El Cajon. Although the number of days with levels above the standard may differ between Memorial Academy and the other three sites, the average and maximum levels are comparable.

The ozone results indicate that over a 12-month period, Memorial Academy's measured ozone levels are comparable to the San Diego region, with only one day above the State standard of 90 ppb.

Annual levels of NO_x are slightly higher than those at Chula Vista and El Cajon, but they are similar to San Diego 12th Avenue.

At the time of the study, CO levels in most areas of California were below the State standard of 9 ppm. The data in Table 4 show that Memorial Academy, like other sites in San Diego, is no exception.

Overall, the report concluded that levels of most toxic air pollutants were higher in the winter than for other seasons during the study, as is the case for most locations in the state, and that air quality was found to be similar to measurements made at other routine data collection locations in the urban San Diego region. It is important to note that diesel particulate matter, the primary contributor to health risks from urban toxic air pollutants, was not measured as part of this study because there is no peer reviewed accepted method to measure diesel particulate matter separate from other particulate matter.

4.5.1.2 Ambient Air Monitoring for Hexavalent Chromium and Metals in Barrio Logan Memorial Academy Charter School

The special hexavalent chromium study was conducted December 2001 through May 2002 and was done in response to community concerns about two chromium plating facilities on Newton Avenue. The results of the measurements are provided in Table 5. The approximate sampling locations are shown on Figure 6.

It was concluded that the elevated hexavalent chromium levels were associated with a decorative plating operation and that the impact was extremely localized. That operation was closed permanently in October 2002 pursuant to a settlement agreement with the San Diego Superior Court (State of California 2004a).

**TABLE 5
HEXAVALENT CHROMIUM MEASUREMENTS, BARRIO LOGAN
(December 3, 2001 to May 12, 2002)**

Location	# Samples	Average Cancer Risk	Concentration (ng/m ³)		
			Average ^a	Highest	Date of Highest Concentration
1	107	114	0.76	21.0	April 6
2	45	33	0.22	3.6	December 7
2c ^b	43	31	0.21	3.2	December 7
3	44	50	0.33	7.9	December 7
4	43	43	0.28	4.8	December 7
5	107	69	0.46	22.0	December 13
6	42	23	0.15	1.0	December 12
Average			0.42		

Source: State of California 2004a, Table 2.5

ng/m³ = nanograms per cubic meter

^aAverage values include ½ the limit of detection (LOD) for non-detects. LOD for hexavalent chromium is 0.2 ng/m³ (for this study).

^bLocation 2c is a co-located sampler.

4.5.1.3 Measurement of Toxic Air Pollutants for Neighborhood Assessment

CARB staff developed micro-scale emission inventories and tested them using several models to determine if localized hot spots could be predicted through air quality modeling. The University of California Riverside's College of Engineering–Center for Environmental Research and Technology conducted short-term toxic monitoring to support validation of the emissions inventory and these local scale models. Over 50 pollutants were measured at four sites (two located within the proposed CPU area and two located just outside of the proposed CPU area) and at one background site located in Point Loma for 12 days in winter 2001–2002. A cursory review of the study's report illustrated no significant difference in observed concentrations between monitoring locations for most pollutants. However, due to the limited amount of toxic data collected, further analysis of these data was not conducted (State of California 2004a).

4.5.1.4 Study Conclusions

The CARB report (State of California 2004a) summarizes the results of the three studies described above. Memorial Academy was chosen as the focal point for these studies because CARB staff and the community believed it would provide information on the impact of local air pollutant sources in the neighborhood and particularly the school. It was generally thought that this school might represent high concentrations of air pollutants due to its location between many neighborhood sources of air pollution.

However, based on the 17 months of ambient air measurements, it was found that the air quality at Memorial Academy Charter School was similar to measurements made at other routine air monitoring locations in the San Diego urban region. Toxic air pollution levels at Memorial Academy Charter School were similar to measured levels in El Cajon and to statewide averages, but were slightly higher than those measured in Chula Vista. Nevertheless, the potential cancer risks due to airborne toxic pollutants at Memorial Academy and Chula Vista were found not to be statistically different. In contrast, the potential cancer risk at Memorial Academy was found to be much lower than that in urban Los Angeles.

Overall, it was found that as with other studies prepared in compliance with the Children's Environmental Health Protection Act (SB 25), the monitoring was adequate for assessing the regional impact from air pollution, but not adequate for assessing very near source impacts.

The hexavalent chromium study showed that community involvement is important to identifying localized hot spots and that partnerships between the communities and the other involved government agencies are critical to the success of reducing localized sources of air pollutants. It was also found that sources in close proximity to residences may have a high near source impact that is very localized, but the impact of the source drops off quickly as

the emissions disperse. In addition, it was determined that chrome platers not only may emit chromium as part of the plating process, but also may cause emissions as a result of various housekeeping activities. The findings were important as they would not have been “discovered” with regional ambient air monitoring or modeling.

The report concludes (State of California 2004a):

Today, all of California attains the health based air quality standards for lead, sulfur dioxide, and nitrogen dioxide and most areas attain the CO standard. Annual averages of PM concentration have declined over 20% and the statewide cancer risk from toxic air pollutants has been reduced by about 50%. Despite these successes, air pollution continues to be a public health issue. Most areas in California continue to exceed the State’s health-based air quality standards for ozone and PM. Federal air quality standards for these pollutants are also exceeded in a number of areas. Air monitoring shows that over 90% of Californians still breathe unhealthy levels of one or more air pollutants during some part of the year. And while regional exposure to air toxics is declining, health risk remains high.

While the overall study findings are important, it must be remembered that diesel particulate matter is the largest contributor to known air pollution risk in the community and area (State of California 2004a). The risk due to diesel particulate matter is not included in the risk estimates discussed above because there is no peer-reviewed accepted method to measure diesel particulate matter [separate from other particulate matter].

As discussed in Section 4.4, the CARB has estimated that diesel particulate emissions could add an additional 420 in one million to the ambient cancer risk levels in San Diego County. The rail studies discussed in the following sections shed some light on the potential impact of diesel particulate matter in the Barrio Logan Area.

4.5.2 Previous Rail Studies

4.5.2.1 San Diego Imperial Valley San Diego Rail Yard HRA

The San Diego and Imperial Valley Railroad (SDIY¹⁰) San Diego rail yard is located northwest of the proposed CPU area (Figure 7). This rail yard is not within the proposed CPU area and, therefore, is not specifically analyzed in this study. However, in 2005 a draft health risk assessment (HRA) was conducted to assess the air quality impacts of yard operations at the SDIY San Diego rail yard upon a nearby residential project (SD Freight

¹⁰ The San Diego and Imperial Valley Railroad operates under the initials “SDIY.”

Rail Consulting 2005). The study focused on the potential health effects resulting from diesel particulate emissions due to locomotive operations in the yard.

The report concluded that the impact of diesel emissions from the SDIY San Diego rail yard to the Ballpark Village project (the project being evaluated) was minimal. Chronic health risks were also found to be less than significant.

Lines of constant incremental cancer risk (“isopleths” or “contours”) due to diesel particulate emissions resulting from yard operations were developed in the 2005 study and are reproduced in Figures 7 through 9. Figure 7 shows the SDIY incremental cancer risk contours overlain on the adopted land use plan, Figure 8 shows the contours overlain on the Alternative 1 land use plan, and Figure 9 shows the contours overlain on the Revised Alternative 2 land use plan. As seen in these figures, the incremental cancer risk within the Barrio Logan Community Plan area (plan area) varies from approximately 1 in one million to over 10 in one million.

The report also discusses chronic health risks and concludes that the chronic health hazard index is well below 1 and thus not significant.

4.5.2.2 South Line Rail Goods Movement Project HRA

This study evaluated the potential health risk effects due to diesel particulate exhaust that could result from increased operations on the SDIY “south” line (San Diego to San Ysidro). The study focused on portions of the line south of Barrio Logan and concluded that the increase in rail line operations being contemplated would result in a less than 1 in one million incremental cancer risk in the surrounding communities (Dudek 2009). Chronic health risks were also found to be less than significant.

4.5.2.3 San Diego BNSF Rail Yard

Burlington Northern Santa Fe (BNSF) Railway’s San Diego rail yard is generally located northwest of the proposed CPU area (Figure 10). This rail yard lies primarily outside of the proposed CPU area boundary and, therefore, is not specifically analyzed in this study. However, in 2008 CARB conducted an HRA to evaluate the impacts to the surrounding community from airborne diesel particulate emissions associated with activities at the BNSF Railway’s San Diego rail yard (State of California 2008a). As with the SDIY yard study described above, this study focused on the operations in the yard.

In addition to the assessment of diesel particulate health risk associated with the yard operations, the study also assessed airborne toxic health risks resulting from sources surrounding the yard. Specifically (State of California 2008a):

ARB staff analyzed the significant off-site emission sources based on two categories: mobile and stationary. For the off-site mobile on-road sources, the analysis focused on on-road heavy-duty diesel trucks, as these are the primary source of diesel PM from the on-road vehicle fleet . . . All roadway links within a one-mile distance from the BNSF San Diego Railyard are included in the analysis. The estimates do not include the diesel PM emissions generated from other modes such as extended idling, starts, and off-road diesel-fuel equipment outside the railyard . . . Emissions from off-site stationary source facilities are identified using the California Emission Inventory Development and Reporting System (CEIDARS) database . . . More than 99% of the off-site stationary diesel PM emissions [in the study area] are from two sources: National Steel and Shipbuilding, at 4.1 tons per year; and Southwest Marine Inc., at 1.5 tons per year.

The study also assessed off-site (outside of the rail yard) emissions of air toxics other than diesel particulate matter.

Isopleths of the incremental cancer risk due to both yard operations (diesel particulate emissions) and off-site sources (diesel particulate emissions and other air toxics) were developed in the 2008 study and are reproduced in Figures 10 through 15. Figure 10 shows the BNSF yard incremental cancer risk contours overlain on the adopted land use plan, Figure 11 shows the contours overlain on the Alternative 1 land use plan, and Figure 12 shows the contours overlain on the Revised Alternative 2 land use plan. The minimum incremental cancer risk contour plotted in the 2008 study is 10 in one million. As seen in these figures, the incremental cancer risk within the Barrio Logan plan area varies from approximately 10 in one million (or less) to over 100 in one million near the rail yard.

Figure 13 shows the off-site sources incremental cancer risk contours overlain on the adopted land use plan, Figure 14 shows the contours overlain on the Alternative 1 land use plan, and Figure 15 shows the contours overlain on the Revised Alternative 2 land use plan. The minimum incremental cancer risk contour due to off-site sources plotted in the 2008 study is 25 in one million. As seen in these figures, the incremental cancer risk within the Barrio Logan plan area varies from approximately 25 in one million to over 250 in one million, with the contours primarily centered on the off-site (beyond the rail yard) port uses.

The report also discusses chronic health risks and concludes that the chronic health hazard index ranged from 0.1 to 0.2 in the residential areas surrounding the rail yard. Thus chronic risks were found not to be significant.

4.5.2.4 Combined Effects of Rail Yard Studies

The contours described above from the BNSF and SDIY rail yard studies were used to estimate the combined effects of all of the studied emission sources (i.e., BNSF yard activities, off-site sources evaluated in the BNSF yard study, and SDIY yard activities) on the Barrio Logan community. Because the raw data for the various contours from these prior studies were not available, there are certain inherent limitations with regard to combining the contours. For example, it is not possible to extrapolate values beyond the last contour for each source in a meaningful way. Therefore, each source's contribution to the incremental cancer risk beyond the last contour plotted for that source was assumed to be zero, which is likely not a conservative assumption.

Nevertheless, combining the contours provides a reasonable estimation of the total incremental cancer risk to the surrounding community due to the studied sources in these prior studies. Figures 16 through 18 show the resulting total incremental cancer risk contours developed from the prior study data.

Figure 16 shows the total incremental cancer risk contours due to the evaluated sources overlain on the adopted land use plan, Figure 17 shows the contours overlain on the Alternative 1 land use plan, and Figure 18 shows the contours overlain on the Revised Alternative 2 land use plan. As seen in these figures, the incremental cancer risk within the Barrio Logan plan area varies from approximately 25 in one million to over 300 in one million, with the contours primarily centered on the Port uses.

These risk contours do not include the effects of the ambient toxic concentrations discussed in Section 4.4. As discussed, the APCD samples for toxic air contaminants at the El Cajon and Chula Vista monitoring stations. Excluding diesel particulate emissions, data from these stations indicate that the background cancer risk in 2008 was 135 in one million in Chula Vista and 150 in one million in El Cajon. These background risks are consistent with the results of the CARB studies conducted in the Barrio Logan community and described in Section 4.5.1 above.

As also mentioned, there is no current methodology for directly measuring diesel particulate concentrations. Based on CARB estimates, diesel particulate emissions could add an additional 420 in one million to the ambient cancer risk levels in San Diego County (San Diego County 2010c). The actual ambient background risk due to diesel particulates in the Barrio Logan Community is not known with certainty. Nevertheless, including the cited background ambient risks (diesel and non-diesel) to the prior rail yard study data discussed above suggests that the incremental cancer risk within limited portions of the proposed CPU area could exceed 850 in one million.

It is important to note that there may be other sources of air toxics in the areas surrounding the Barrio Logan community that were not addressed in these prior studies (e.g., Port and

Navy operations further to the south). Therefore, the incremental cancer risks discussed above may not represent the total risk in the area.

Evaluation of the data in the reports discussed above indicates that the sum of chronic health hazard indices from each study would result in values less than one and, thus, chronic health risks from all sources evaluated in the prior studies would be less than significant.

4.6 Other Air Pollution Control Efforts

4.6.1 Port Of San Diego

Portions of the Port are located within the proposed CPU area, but not within the area the City has jurisdictional control over. Therefore, potential air quality impacts from Port operations were not analyzed in this study (other than the effects described above in Section 4.5.2.3).

The Port implements the voluntary Vessel Speed Reduction (VSR) Program to reduce air pollutants and greenhouse gas emissions from cargo and cruise ships by reducing speeds in the vicinity of San Diego Bay. Studies show that reducing vessel speeds decreases air emissions which ultimately lead to better air quality. The Port asks cargo vessel operators entering or leaving San Diego Bay to observe a 12-knot speed limit. For cruise ships, a 15-knot limit is requested. The VSR zone extends 20 nautical miles seaward from Point Loma (Port of San Diego 2009).

In the last quarter of 2009, the VSR Program resulted in a 10–12 percent reduction in emissions within the VSR zone, depending on the pollutant (Port of San Diego 2010). Emissions reductions are calculated using vessel type engine specifications. The emissions reductions displayed in Table 6 were achieved by the participating vessels as compared to the emissions generated traveling at typical cruising speeds in the VSR zone.

TABLE 6
4th QUARTER 2009 PORT OF SAN DIEGO VESSEL SPEED REDUCTION
EMISSION REDUCTIONS

Pollutant	Reduction (tons)	% Reduction
NO _x	6.6	12
CO	0.48	11
PM	0.17	11
VOC	0.32	11
CO ₂	261	10

Source: Port of San Diego 2010

The Drayage Truck Regulation (DTR) is also an ongoing effort, implemented by CARB, to reduce PM and NO_x emissions from diesel-fueled engines and improve air quality associated with goods movement. The DTR applies to owners and operators of on-road diesel fueled, alternative diesel-fueled, and dual-fueled heavy-duty drayage trucks operated at California ports and intermodal rail facilities. The DTR is intended to reduce PM, NO_x, and other air contaminants by setting emission standards for in-use, heavy-duty diesel-fueled vehicles that transport cargo to and from California's ports and intermodal rail facilities (State of California 2011b).

This rule is implemented by the Port of San Diego through its Clean Truck Program and its Truck Rule adopted in July 2010 (Environmental Health Coalition [EHC] 2011). Further, the Proposition 1B: Goods Movement Emission Reduction Program (Program), administered locally by the APCD, provides grants to equipment owners on a competitive basis to upgrade their equipment to cleaner technologies. Higher grant amounts are available for cleaner technologies.

However, according to the EHC, truck trips to and from the Port cargo terminals increased between the first and third quarters of 2010, from 11 thousand to 13 thousand (EHC 2011). Many of these were trucks that were exempt from the DTR, such as car carriers and trucks transporting windmill parts and outsized military equipment. In addition, trucks picking up fruit and other cargoes at warehouses in Barrio Logan may not be compliant with the DTR because they do not specifically access the port (the "dray-off problem"). Thus diesel particulate emissions continue to be a concern in the Barrio Logan area.

The Port also implemented a shore power system in November 2010 designed to reduce air emissions from cruise ships sitting in port. It is estimated that a reduction of 22 tons of air pollutants and 448 tons of greenhouse gas emissions have been achieved between November 2010, when the system went on-line, and April 16, 2011 (Port of San Diego 2011).

4.6.2 United States Naval Station San Diego

The United States Naval Station, San Diego (Naval Base San Diego [NBSD]) is located within the proposed CPU planning area, but not within the area the City has jurisdictional control over. Therefore, potential air quality impacts from Navy operations were not analyzed in this study.

Naval Base San Diego is committed to environmental protection and compliance. In order to achieve this goal, NBSD works to minimize environmental liabilities through continual review of existing operations and processes looking for opportunities to use new technologies that are environmentally friendly, identifies and reviews environmental impacts for significance, and sets objectives and targets for the reduction and eventual elimination of the environmental impacts (U.S. Department of the Navy 2011).

5.0 Thresholds of Significance

5.1 California Air Resources Board

For purposes of assessing the significance of air quality impacts, the CARB has established guidelines for assessing consistency with applicable air quality plans (e.g., air quality management plan [AQMP]/SIP) per Section 15125(d) of the CEQA Guidelines, as described below.

For long-term emissions, the direct impacts of a project can be measured by the degree to which the project is consistent with regional plans to improve and maintain air quality. The regional plans for San Diego are the 1991/1992 RAQS and attached TCM, as revised by the triennial updates adopted in 1995, 1998, 2001, 2004, and 2009, and the applicable portions of the SIP. The CARB provides criteria for determining whether a project conforms to the RAQS/SIP (State of California 1989a), which include the following.

1. Is an Air Quality Plan being implemented in the area where the project is proposed?
2. Is the proposal consistent with the growth assumptions of the applicable AQMP?
3. Does the project contain in its design all reasonably available and feasible air quality control measures?

5.2 City of San Diego

The Scope of Work letter prepared for the Program Environmental Impact Report (PEIR) for the proposed CPU includes the following issue statements related to air quality (City of San Diego 2010):

1. Could implementation of the proposed CPU result in an increased number of automobile trips or stationary source emissions which could potentially affect San Diego's ability to meet regional, State and federal clean air standards, including the (RAQS) [*sic*] or SIP?
2. Could implementation of the proposed CPU result in air emissions that could substantially deteriorate ambient air quality, including the exposure of sensitive receptors to substantial pollutant concentrations?

Potential air quality effects related to the proposed CPU will be evaluated in regard to these issues. Guidance from the City's Significance Determination Thresholds was used in part in the evaluation of potential impacts related to these issue statements (City of San Diego 2011). Numeric thresholds related to potential air quality effects are discussed further in Section 5.4 below.

5.3 Public Nuisance Law (Odors)

The State of California Health and Safety Code Sections 41700 and 41705, and APCD Rule 51, commonly referred to as public nuisance law, prohibit emissions from any source whatsoever in such quantities of air contaminants or other material, which cause injury, detriment, nuisance, or annoyance to the public health or damage to property. The provisions of these regulations do not apply to odors emanating from agricultural operations necessary for the growing of crops or the raising of fowl or animals. It is generally accepted that the “considerable” number of persons requirement in Rule 51 is normally satisfied when 10 different individuals/households have made separate complaints within 90 days. Odor complaints from a “considerable” number of persons or businesses in the area will be considered to be a significant, adverse odor impact.

Every use and operation shall be conducted so that no unreasonable heat, odor, vapor, glare, vibration (displacement), dust, smoke, or other forms of air pollution subject to APCD standards shall be discernible at the property line of the parcel upon which the use or operation is located. Therefore, any unreasonable odor discernible at the property line of the project site will be considered a significant odor impact.

5.4 San Diego Air Pollution Control District

The APCD is the agency that regulates air quality in the SDAB. Vehicle emissions are regulated at the federal and State levels. Air quality management districts and air pollution control districts do not set vehicle emission standards.

The APCD is responsible for preparing and implementing the portion of the SIP applicable to the SDAB. The SIP contains the State’s strategies for achieving the NAAQS. The APCD also prepared the 1991/1992 RAQS in response to requirements set forth in the California CAA (AB 2595). Attached as part of the RAQS are the TCMs adopted by SANDAG in accordance with AB 2595 and adopted by SANDAG on March 27, 1992, as Resolution Number 92-49 and Addendum. The RAQS and TCM set forth the steps needed to accomplish attainment of State AAQS. Updates of the RAQS and corresponding TCM are required every three years. The required triennial updates of the RAQS and corresponding TCM occurred in 1995, 1998, 2001, and 2004, with the most recent update of the RAQS and TCM in 2009.

The APCD has also established a set of rules and regulations initially adopted on January 1, 1969, and periodically reviewed and updated. These rules and regulations are available for review on the agency’s website (County of San Diego 2010a). The rules and regulations define requirements regarding stationary sources of air pollutants and fugitive dust.

The APCD does not provide specific numerics for determining the significance of mobile source-related impacts, or for evaluating CEQA projects or projects that do not require an APCD permit to operate (e.g., non-stationary sources). However, the district does specify Air Quality Impact Analysis (AQIA) trigger levels for new or modified stationary sources (APCD Rules 20.2 and 20.3). Although these trigger levels do not generally apply to mobile sources or general land development projects, for comparative purposes these levels are used to evaluate the increased emissions that would be discharged to the SDAB if the proposed CPU were approved.

The APCD thresholds are also utilized by the City in their Significance Determination Thresholds (City of San Diego 2011) as one of the considerations when determining the potential significance of air quality impacts for projects within the city. APCD Rules 20.2 and 20.3 do not specify thresholds for ROG or PM_{2.5}. The threshold for ROG used by the City is based on levels per the SCAQMD and Monterey Bay APCD which have similar federal and State attainment status as San Diego (City of San Diego 2011). The terms reactive organic gas (ROG) and volatile organic compound (VOC) are essentially synonymous and are used interchangeably in this analysis. The threshold for PM_{2.5} used by the City was obtained from the SCAQMD Final Methodology to Calculate PM_{2.5} and PM_{2.5} Significance Thresholds (SCAQMD 2006).

The air quality impact screening levels used in this analysis are shown in Table 7.

**TABLE 7
AIR QUALITY IMPACT SCREENING LEVELS**

Pollutant	Emission Rate		
	(lb/hr)	(lb/day)	(tons/yr)
NO _x	25	250	40
SO _x	25	250	40
CO	100	550	100
PM ₁₀	--	100	15
Lead	--	3.2	0.6
VOC, ROG ¹	--	137	15
PM _{2.5} ²	--	55	10

SOURCE: APCD, Rule 20.2 (12/17/1998); City of San Diego 2011.

¹VOC threshold based on levels per SCAQMD and Monterey Bay APCD which have similar federal and State attainment status as San Diego.

²PM_{2.5} threshold obtained from the SCAQMD *Final Methodology to Calculate PM_{2.5} and PM_{2.5} Significance Thresholds* (SCAQMD 2006)

5.5 Evaluation of Air Toxic Emissions

The APCD does not specify thresholds for evaluating CEQA projects or for projects that do not require an APCD permit to operate (e.g., non-stationary sources). In general, for permitted projects the APCD does not identify a significant impact if the potential health risks from the proposed project would not exceed the health risk public notification thresholds specified by APCD Rule 1210. The public notification thresholds are:

- i. Maximum incremental cancer risks equal to or greater than 10 in one million, or
- ii. Cancer burden equal to or greater than 1.0, or
- iii. Total acute non-cancer health hazard index equal to or greater than 1.0, or
- iv. Total chronic non-cancer health hazard index equal to or greater than 1.0.

Therefore, for the purposes of evaluating the potential health risks associated with the air toxics addressed in this assessment, a significant impact would occur if the worst-case incremental cancer risk is greater than or equal to 10 in one million, or if the worst-case total acute or chronic health hazard index is greater than or equal to one.

6.0 Criteria Pollutant Air Quality Assessment

6.1 Methodology & Assumptions

Air emissions for each land use alternative were calculated using the California Emissions Estimator Model (CalEEMod) computer program that was released in March 2011 by the CARB (State of California 2011c). The CalEEMod 2011 v1.1 program is a tool used to estimate air emissions resulting from land development projects in the state of California. CalEEMod was developed by the CARB and an air quality consultant, with the participation of several State air districts including the SCAQMD and the APCD.

In brief, CalEEMod is a computer model that estimates criteria air pollutant and greenhouse gas emissions from mobile (i.e., vehicular) sources, area sources (fireplaces, woodstoves, and landscape maintenance equipment), energy use (electricity and natural gas used in space heating, ventilation, and cooling; lighting; and plug-in appliances), water and wastewater use, and solid waste disposal. Emissions are estimated based on land use information input to the model by the model user.

In the first module, the user defines the specific land uses that will occur at the project site. The user also selects the appropriate land use setting (urban, suburban, or rural), operational year, air basin, climate zone, and utility provider. The input land uses, size features, and population are used throughout CalEEMod in determining default variables and calculations in each of the subsequent modules. The input land use information consists of land use subtypes (such as the residential subtypes of single-family residential and multi-family medium-rise residential) and their unit or square footage quantities.

Subsequent modules include construction (including off-road vehicle emissions), mobile (on-road vehicle emissions), area sources (woodstoves, fireplaces, consumer products [cleansers, aerosols, solvents], landscape maintenance equipment, architectural coatings), water and wastewater, and solid waste. Each module comprises multiple components including an associated mitigation module to account for further reductions in the reported baseline calculations. Other inputs include trip generation rates, trip lengths, vehicle fleet mix (percentage autos, medium truck, etc.), trip distribution (i.e., percent home to work, etc.), duration of construction phases, construction equipment usage, grading areas, season, and ambient temperature, as well as other parameters.

In various places the user can input additional information and/or override the default assumptions to account for project- or location-specific parameters. For this assessment the model default parameters including vehicle trip lengths and energy intensity factors were not changed unless otherwise noted.

The input data and the reported criteria pollutant emission estimates based on these inputs are discussed below. Electronic copies of the CalEEMod 2011 input and output files are contained as Attachment 2 of the enclosed CD. Emissions of NO_x, CO, SO_x, PM₁₀, PM_{2.5}, and ROG, an ozone precursor, are calculated. Emission factors are not available for lead, and consequently, lead emissions are not calculated. The SDAB is currently in attainment of the State and federal lead standards. Furthermore, fuel used in construction equipment and most other vehicles is not leaded.

6.2 Construction-related Air Quality Effects

Construction-related activities are temporary, short-term sources of air emissions. Sources of construction-related air emissions include:

- Fugitive dust from grading activities;
- Construction equipment exhaust;
- Construction-related trips by workers, delivery trucks, and material-hauling trucks; and
- Construction-related power consumption.

Air pollutants generated by the construction of projects within the plan area would vary depending upon the number of projects occurring simultaneously and the size of each individual project. Construction-related pollutants result from dust raised during demolition and grading, emissions from construction vehicles, and chemicals used during construction.

6.2.1 Project Characteristics Assumptions

CalEEMod prompts the user to enter the project's location, setting, climate zone, utility provider, and the specific land uses that will occur. For this analysis, the location was selected as the SDAB with an urban (versus suburban) setting, in climate zone 13, served by San Diego Gas & Electric (SDG&E).

6.2.2 Land Use and Construction Assumptions

The exact number and timing of all development projects that could occur under the proposed plan are unknown. However, since the area is heavily developed, it can be assumed that these areas would experience relatively small projects in terms of land area, most of which would involve the demolition of existing structures and improvements.

To illustrate the range of potential air effects from projects that could occur, two types of hypothetical projects were evaluated. These hypothetical projects include a 1.8 acre multi-family residential project and a 65,000 square foot industrial project. The 1.8 acre multi-family development is assumed to consist of the demolition of an existing 5,000-square-foot structure and the construction of a 29-unit multi-family structure. The industrial development is assumed to consist of the demolition of an existing 5,000-square-foot structure and the construction of 65,000 square feet of industrial use.

CalEEMod default parameters were used for the equipment needed for all phases of construction which are estimated based on the size of the land use subtype features entered in the land use module.

This analysis assumes that standard dust and emission control during grading operations would be implemented to reduce potential nuisance impacts and to ensure compliance with APCD rules and regulations.

As of January 1, 2011, architectural paints and coatings shall comply with VOC limits specified in CalGreen 2010 (Green Building Standards Code, California Code of Regulations, Title 24, Part 11) unless more stringent local limits apply. Currently, depending on the coating, the CalGreen VOC limits generally are more stringent than the APCD limits specified in Rule 67.0. The CalGreen VOC limit is 150 mg/L whereas APCD Rule 67.0 allows a VOC content for coatings of up to 250 mg/L. The CalGreen architectural coating VOC limit of 150 mg/L was used in each model run for all coatings.

6.2.3 Construction Source Emissions and Impacts

A summary of the modeling results is shown in Table 8.

TABLE 8
DAILY CONSTRUCTION EMISSIONS
(pounds/day)

Pollutant	Multi-family Project	Industrial Project	Threshold
ROG	55.0	90.9	137
NO _x	44.3	44.3	250
CO	26.9	26.9	550
SO ₂	0.0	0.0	250
PM ₁₀ Total	7.8	7.8	100
PM ₁₀ —fugitive dust	5.9	5.9	--
PM ₁₀ —exhaust	2.8	2.8	--
PM _{2.5} Total	4.8	4.8	55
PM _{2.5} —fugitive dust	2.9	2.9	--
PM _{2.5} —exhaust	2.8	2.8	--

NOTE: the total PM emissions indicated in the CalEEMod output files do not equal the sum of the individual source emissions.

Note that the emissions summarized in Table 8 are the maximum emissions for each pollutant and that they may occur during different phases of construction. They would not necessarily occur simultaneously. These are, therefore, the worst-case emissions. As discussed above, for assessing the significance of the air quality emissions resulting during construction of the hypothetical projects, the construction emissions were compared to the thresholds shown in Table 7.

As seen, the relatively small hypothetical individual projects are not expected to result in air emissions that exceed the applicable thresholds. However, if several of these projects were to occur simultaneously, there is the potential to exceed significance thresholds.

Fugitive dust is any solid particulate matter that becomes airborne directly or indirectly as a result of the activities of man (other than that emitted from an exhaust stack) or from natural events such as windborne dust. Construction dust is comprised primarily of chemically inert particles that are too large to enter the human respiratory tract when inhaled.

Fugitive dust emissions vary greatly during construction and are dependent on the amount and type of activity, silt content of the soil, and the weather. Vehicles moving over paved and unpaved surfaces, demolition, excavation, earth movement, grading, and wind erosion from exposed surfaces are all sources of fugitive dust. As indicated above, fugitive dust emissions to the air basin resulting from construction of small projects are not expected to

be significant within the proposed CPU area; however, they could be perceived as a nuisance to the immediate area. Dust control during demolition and grading operations would be implemented to reduce potential nuisance impacts. Construction operations are subject to the particulate and fugitive dust requirements established in Regulation 4, Rules 52, 54, and 55 of the APCD's rules and regulations.

The small projects discussed above are illustrative only. Approval of the proposed CPU would not permit the construction of any individual project, and no specific development details are available at this time. The thresholds presented above are applied on a project-by-project basis and are not used for assessment of regional planning impacts. The information is presented to illustrate the potential scope of air impacts for projects that could be reviewed under the plan. However, it is not anticipated that construction activities expected to occur if the proposed plan update were adopted would result in a significant direct air quality impact.

The SDAB is not in attainment for ozone, PM₁₀, and PM_{2.5}. Clearly, there is the potential for future projects that would conform to the proposed CPU to contribute to cumulatively considerable emissions should multiple projects be implemented simultaneously. Should multiple small projects be initiated in any given year, the potential exists that the construction of those projects would result in a cumulatively considerable increase in criteria air pollutant emissions.

6.3 Operation-related Emissions

Operational source emissions would originate from traffic generated within or as a result of the proposed CPU. Area source emissions would result from activities such as the use of natural gas, fireplaces, and consumer products. In addition, landscaping maintenance activities associated with the proposed land uses would produce pollutant emissions.

6.3.1 Project Characteristics Assumptions

CalEEMod prompts the user enter the project's location, setting, climate zone, utility provider, and the specific land uses that will occur. For this analysis, the location was selected as the SDAB with an urban (versus suburban) setting, in climate zone 13, served by SDG&E.

6.3.2 Land Use Assumptions

For comparative purposes, air emissions were calculated for the existing land uses, the adopted community plan in the year 2030, and the proposed CPU Alternative 1 and Revised Alternative 2 land use plans in the year 2030 using CalEEMod 2011. Table 9 summarizes the existing and future build out land uses entered into CalEEMod 2011.

**TABLE 9
EXISTING AND FUTURE MODELED LAND USES**

Land Uses ¹	Existing (Year 2010)	Adopted Community Plan (Year 2030)	Alternative 1 (Year 2030)	Revised Alternative 2 (Year 2030)
Commercial (square feet) ²	1,234,490	1,741,210	2,191,310	2,465,104
Educational (student)	634	529	529	529
Educational (square feet) ³	8,700	61,300	61,300	61,300
Hotel (rooms)	67	0	0	0
Industrial (square feet) ⁴	2,482,850	6,590,300	3,300,500	3,660,400
Park (acres)	0	9	9	9
Retail (square feet) ⁵	194,900	194,600	194,600	194,600
Retail (pumps)	16	0	0	0
Residential: Multi-family ⁶ (dwelling units)	518	3,191	4,203	3,642
Residential: Single-family (dwelling units)	477	31	69	56

¹Land use data obtained from Kimley-Horn & Associates, Inc. 2011 traffic impact analysis (TIS) and recategorized to match land use subtypes of CalEEMod. The Revised Alternative 2 numbers were updated per the revised Table 6-1 from the TIS addendum (2012) and City of San Diego data.

²Includes low rise office, other public service, other transportation, rail station, street front commercial, fire or police station, and other health care.

³Includes junior college.

⁴Includes heavy industrial, light industrial and warehousing

⁵Includes fast food restaurant and neighborhood shop center

⁶The residential categories have the same designations in CalEEMod.

Portions of existing developed lands within the plan area would remain and likely not change as a part of the adopted plan or proposed CPU. These include several single-family residences, recently constructed multi-family residences, recently entitled projects, existing major public and institutional uses such as the Cesar Chavez Continuing Education Center, the health center, Cesar Chavez and Chicano parks, Perkins Elementary School, and the Barrio Station. Because the existing developed land uses were built to older, less stringent code requirements than those applicable to future development or re-development, the existing developed land uses that will not change and the land uses that would be developed or re-developed as a part of buildout of the adopted Plan or proposed CPU land use alternatives have different energy consumptions associated with them. In order to reflect these energy consumption differences, emissions were estimated using two separate CalEEMod runs for the land uses in the adopted community plan, and the proposed CPU Alternative 1 and Revised Alternative 2 land use plans. These two runs are termed “No Change” to reflect the existing unchanging land uses and “Change” to reflect the future development-redevelopment areas. These runs are discussed further in Section 6.3.4 below.

The quantities listed in Table 10 consist of the existing developed land uses that were assumed to remain and not be redeveloped as part of any of the Barrio Logan community plan alternatives.

**TABLE 10
EXISTING LAND USES THAT WILL REMAIN AND NOT CHANGE**

Land Uses	Adopted Community Plan (Year 2030)	Alternative 1 (Year 2030)	Revised Alternative 2 (Year 2030)
Residential Single Family (du)	31	69	56
Residential Multi-Family (du)	375	532	603
Educational (student)	529	529	529
Educational (sf)	8,700	8,700	8,700
Government Office Building (Barrio Station) (sf)	110,000	110,000	110,000
Medical Office Building (Health Center) (sf)	76,400	76,400	76,400
General Office Building (Public/Institutional) (sf)	257,010	257,010	257,010
Park (acres)	9.1	9.1	9.1

du: dwelling unit; sf: square feet

The quantities in Table 10 were subtracted from the total buildout quantities in Table 9 in order to obtain the land use quantities subject to future development/re-development for use in the first model run (“Change”). The remaining quantities (unchanging existing development) were used in the second model run (“No Change”). As described in Section 6.3.4 below, it was assumed that the energy related emissions associated with the developed land uses that would not be redeveloped were related to older energy codes, while those associated with new or redevelopment projects would be the result of recent energy code revisions. The two model runs were then added together to obtain the total projected emissions associated with the Plan buildout year.

To account for higher urban existing and planned residential densities associated with the proposed CPU, CalEEMod’s default 3 dwelling units per acre (du/ac) for single-family residential was changed to 14 dwelling units per acre (du/ac) in the Land Use input module.

6.3.3 Estimating Vehicle Emissions

The CalEEMod model estimates vehicle emissions by first calculating trip rate, trip length, trip purpose, and trip type percentages (e.g., home to work, home to shop, home to other) for each land use type, based on the land use types and quantities entered by the user in the land use module. CalEEMod’s default trip rates are based on the Institute of Transportation Engineers (ITE) Trip Generation 8th Edition trip rates for each respective land use category. According to the CalEEMod User’s Guide, for residential uses, CalEEMod default ITE trip lengths are based on the assumption of a suburban setting. The user can edit any of this information by entering a new value in the appropriate cell and/or by accounting for reductions in the traffic mitigation module.

For this analysis, CalEEMod default trip rates were edited to reflect the trip rates identified for each land use subtype in the traffic impact analysis (Kimley–Horn & Associates 2011;

Addendum 2012). However, the model's default trip lengths were not edited. As indicated, to account for higher urban existing and planned residential densities associated with the proposed CPU, CalEEMod's default 3 dwelling units per acre (du/ac) for single-family residential was changed to 14 du/ac in the Land Use input module. These edits were entered in the land use module in the lot acreage column to reflect proposed CPU area densities.

6.3.4 Estimating Energy Use Emissions

Air emissions are emitted as a result of activities in buildings for which electricity and natural gas are used as energy sources. Pollutant emissions are generated during the generation of electricity from fossil fuels off-site in power plants. These emissions are considered indirect but are calculated in CalEEMod as associated with a building's operation. Combustion of fossil fuel emits criteria pollutants directly into the atmosphere. When this occurs in a building this is considered a direct emissions source associated with that building. CalEEMod only estimates emissions from the direct combustion of natural gas. Fuel oil, kerosene, liquefied petroleum gas, and wood can also be used as fuels, but they generally contribute only small amounts, and thus CalEEMod does not account for their emissions. Use of these other fuels is not anticipated for Barrio Logan.

CalEEMod estimates emissions from energy use by multiplying average rates of residential and non-residential energy consumption by the quantities of residential units and non-residential square footage entered in the land use module to obtain total projected energy use. This value is then multiplied by electricity and natural gas air pollutant emission factors applicable to the project location and utility provider.

Building energy use is typically divided into energy consumed by the built environment and energy consumed by uses that are independent of the construction of the building such as plug-in appliances. In California, Title 24 governs energy consumed by the built environment, mechanical systems, and some types of fixed lighting. Non-building energy use, or "plug-in energy use," can be further subdivided by specific end-use (refrigeration, cooking, office equipment, etc.). CalEEMod thus calculates electricity use by:

- Calculating energy use from systems covered by Title 24 (i.e., Heating, Ventilating, and Air Conditioning (HVAC) system, water heating system, and the lighting system);
- Calculating energy use from lighting use; and
- Calculating energy use from office equipment, appliances, plug-in electronics, and other sources not covered by Title 24 or lighting.

Lighting is calculated separately, since it can be both part and not part of Title 24. Natural gas use is just distinguished in the model as Title 24 or Non-Title 24 similar to electricity consumption.

CalEEMod default energy values are based on the CEC-sponsored California Commercial End Use Survey (CEUS) and Residential Appliance Saturation Survey (RASS) studies, which identify energy use by building type and climate zone. Each land use type input to the land use module is mapped in the energy module to the appropriate CEUS and RASS building type. Because these studies are based on older buildings, adjustments have been made in CalEEMod to account for changes to Title 24 building codes. The default adjustment is to the current 2008 Title 24 energy code (part 6 of the building code). Adjustments to simulate the 2005 Title 24 energy code are available in the model by selecting the "use historical data" box. The CalEEMod User's Guide states that "a user should select the use historical box if they only want an adjustment to the 2005 standards which were in effect when CARB developed its Scoping Plan 2020 No Action Taken [i.e., BAU] predictions" (State of California 2011c, page 30). Emission factors are not available for earlier codes.

Therefore, for the existing conditions estimate, the historical data box was selected in order to reflect emissions from energy use as associated with a building built to the 2005 Title 24 energy code. For the estimates of each buildout land use alternative, energy related emissions were estimated using two runs of the model. One run assumed the default 2008 Title 24 energy code adjustments for the portion of the total buildout land use quantities that would be new and therefore constructed in accordance with the 2008 (or later) Title 24 energy code. The second model run for each land use alternative selected the historical data box for the portion of the total buildout land use quantities that comprise existing developed land uses that would not change. The two model runs were then added together to obtain the total projected energy related emissions associated with the plan buildout year.

6.3.5 Estimating Area Source Emissions

This CalEEMod module estimates the emissions that would occur from the use of hearths, woodstoves, and landscaping equipment. This module also estimates emissions due to use of consumer products and architectural coatings that have volatile organic (VOC) content. The use of hearths (fireplaces) and woodstoves directly emits air pollutants from the combustion of natural gas, wood, or biomass. CalEEMod estimates emissions from hearths and woodstoves only for residential uses based on the type and size features of the residential land use inputs. By default, commercial land uses do not have any hearths or woodstoves in CalEEMod but can be added for those cases where they may occur such as in restaurants or hotels if such information is known. In this analysis no hearths or woodstoves were attributed to any commercial uses.

The use of landscape equipment emits air pollutants associated with the equipment's fuel combustion. CalEEMod estimates the number and types of equipment needed based on the number of summer days given the project's location as entered in the project characteristics module. The model defaults for hearths, woodstoves, and landscaping equipment were used.

**TABLE 11
AVERAGE DAILY OPERATIONAL EMISSIONS TO THE SAN DIEGO AIR BASIN
(pounds/day)**

Season/ Pollutant	Existing Emissions (Year 2009)				Adopted Community Plan (Year 2030)				Alternative 1 (Year 2030)				Revised Alternative 2 (Year 2030)			
	Area Source	Energy Source	Mobile Source	Total Emissions ¹	Area Source	Energy Source	Mobile Source	Total Emissions ¹	Area Source	Energy Source	Mobile Source	Total Emissions ¹	Area Source	Energy Source	Mobile Source	Total Emissions ¹
Summer																
ROG	683	3	520	1,206	2,045	5	476	2,525	2,554	4	346	2,904	2,250	4	388	2,642
NOx	10	26	1,094	1,130	33	47	850	929	44	37	616	697	38	38	691	767
CO	862	19	5,342	6,223	2,780	33	3,900	6,714	3,683	26	2,797	6,506	3,188	28	3,141	6,357
SO ²	1	0	6	7	2	0	12	15	3	0	9	11	3	0	9	12
PM ₁₀	113	2	657	773	367	4	1,423	1,793	486	3	1,007	1,496	421	3	1,132	1,556
PM _{2.5}	113	2	42	157	367	4	78	448	486	3	55	544	421	3	62	486
Winter																
ROG	683	3	562	1,247	2,045	5	503	2,553	2,554	4	365	2,923	2,250	4	409	2,663
NOx	10	26	1,157	1,193	33	47	878	958	44	37	635	716	38	38	713	789
CO	862	19	5,343	6,224	2,780	33	3,863	6,676	3,683	26	2,784	6,493	3,188	28	3,125	6,341
SO ²	1	0	5	6	2	0	12	14	3	0	8	12	3	0	9	12
PM ₁₀	113	2	658	773	367	4	1,423	1,794	486	3	1,007	1,496	421	3	1,132	1,556
PM _{2.5}	113	2	42	158	367	4	78	448	486	3	55	544	421	3	62	486

¹Totals may differ due to rounding.

²Emissions calculated by CalEEMod are for SO₂.

Architectural VOC emissions for operation are primarily associated with maintenance activities. These activities are not covered under CalGreen. However, coatings sold in San Diego County must comply with Rule 67.0. As a worst-case, the upper end APCD architectural coating VOC limit of 250 mg/L was used in each run.

6.3.6 Total Operational Emissions

A summary of the modeling results, which includes both mobile and area source emissions, is shown in Table 11. As seen in Table 11, total future ROG, CO, SO₂, PM₁₀, and PM_{2.5} emissions under the adopted community plan, the proposed CPU Alternative 1, and the proposed Revised Alternative 2 are projected to be greater than existing conditions. This is due to the increase in development associated with buildout of the various plans. The total future ozone precursors are greatest under Alternative 1, followed by the adopted community plan and then Revised Alternative 2. The total future PM₁₀ pollutants are greatest under the adopted community plan, followed by Revised Alternative 2 and then Alternative 1. The total future PM_{2.5} pollutants are greatest under Alternative 1, followed Revised Alternative 2 and then the adopted community plan.

The alternative land use plan that results in the lowest year 2030 emissions varies depending on the criteria pollutant being considered. As seen in Table 11, Alternative 1 would result in the greatest ROG, NO_x, and PM_{2.5} emissions. The adopted plan would result in the greatest CO, SO₂, and PM₁₀ emissions. For comparative purposes, the criteria pollutant emissions were ranked by plan in Table 12 with a rank of 1 corresponding to the lowest emissions of the three alternative plans considered and a rank of 3 corresponding to the highest emissions of the three.

**TABLE 12
RANKING OF ALTERNATIVE CRITERIA POLLUTANT EMISSIONS**

Pollutant	Adopted Community Plan (Year 2030)	Alternative 1 (Year 2030)	Alternative 2 (Year 2030)
ROG	1	3	2
NO _x	3	1	2
CO	3	2	1
SO ₂	3	1	2
PM ₁₀	3	1	2
PM _{2.5}	1	3	2

As discussed, the SDAB is non-attainment for ozone, PM₁₀, and PM_{2.5}. With regard to ozone precursors, Revised Alternative 2 would result in the lowest combined ROG and NO_x emissions, followed by the adopted community plan then t Alternative 1, which would result in the greatest combined ozone precursors of the three alternative plans. Alternative 1

results in the lowest PM₁₀ emissions, followed by Revised Alternative 2, with the adopted plan resulting in the greatest PM₁₀ emissions. Conversely, the adopted land use plan results in the lowest PM_{2.5} emissions, followed by Revised Alternative 2, with Alternative 1 resulting in the greatest PM_{2.5} emissions.

Given that both Alternative 1 and Revised Alternative 2 would decrease the amount of industrial use relative to that under the adopted plan, this explains why there are lower NO_x, CO and SO₂. However, both Alternatives 1 and 2 of the proposed CPU would increase housing units, as well as substantially increase the amount of commercial development relative to that under the adopted plan which could explain the higher values of ROG for Alternative 1 and Revised Alternative 2.

Under Alternative 1, the combined ozone precursors (NO_x and ROG) are higher than both the adopted community plan and existing emissions. Despite the NO_x quantity being lower than the all other plans, when combined with the higher ROG number the total amount of ozone precursor is higher than the other plans. Additionally, Alternative 1 has the highest level of PM_{2.5} when compared to the other plans. Given the fine particulate matter is normally a result of combustion, this could explain why Alternatives 1 and 2 have higher levels based on the higher amount of VMT under these alternatives. As discussed above, the SDAB is non-attainment for ozone, PM₁₀, and PM_{2.5}. As such, an increase in future emissions of particulates and ozone precursors would result in a significant air quality impact. There would be a beneficial impact with respect to CO, SO₂, and PM₁₀ relative to the adopted plan.

Under Revised Alternative 2, the combined ozone precursors (NO_x and ROG) would be less than both the adopted community plan and existing emissions. CO, SO₂ and PM₁₀ emissions would be less than those anticipated to occur under the adopted community plan (the resulting PM_{2.5} emissions would be more than those that occur under the adopted community plan). Therefore, only the increase in PM_{2.5} emissions would represent a significant air quality impact.

Given the modeling results, Revised Alternative 2 would represent a somewhat lower air quality impact than Alternative 1, given the higher amounts of criteria pollutants such as the combined ozone precursors (ROG and NO_x) and PM_{2.5}, although both alternatives represent a significant adverse impact when compared to existing conditions, as does the adopted plan.

7.0 Health Risk Assessment

RECON was tasked with assessing direct impacts to receivers within the community plan area resulting from diesel particulate emissions due to main line rail operations within and adjacent to the plan area, as well as diesel particulate emissions from vehicular traffic on the freeways (I-5, State Route 15 [SR-15], and State Route 75 [SR-75]) and designated truck routes within and adjacent to the plan area. The assessment of freeway diesel particulate emissions is contained in Section 7.2, the assessment of truck route diesel particulate emissions is contained in Section 7.3, and the assessment of train diesel particulate emissions is contained in Section 7.4.

As previously discussed, diesel particulate matter has been identified as an air toxic of concern. Both diesel-electric locomotives and vehicles (primarily heavy-duty trucks) emit diesel particulates through the combustion of diesel fuel. An assessment of the potential health risks associated with the anticipated diesel particulate emissions from these sources was performed for receivers in the plan area. The assessment involves four basic steps: hazard identification, dose-response assessment, exposure assessment, and characterization of the risk. The steps are discussed below.

The assessment presented here is being prepared in support of the project's CEQA processing, rather than specifically for permitting and or compliance with the AB 2588 "Hot Spots" program. In addition, the diesel particulate emissions are generated by external sources (e.g., trains and vehicular traffic) rather than the proposed uses within the proposed CPU area.

Nevertheless, the assessment generally follows the Office of Environmental Health Hazard Assessment's (OEHHA) Air Toxics Hot Spots Program Risk Assessment Guidelines (State of California 2003b) and guidance provided by the APCD (County of San Diego 2006). Other Guidance includes the CARB's "ARB Health Risk Assessment Guidance for Rail Yard and Intermodal Facilities" (State of California 2006a), the CARB's "Roseville Rail Yard Study" ("Roseville Study"; State of California 2004b), and several studies prepared for the BNSF San Diego Rail Yard (ENVIRON 2008a, 2008b; State of California 2008a).

7.1 Health Risk Assessment Process

7.1.1 Hazard Identification

Hazard identification is the process by which contaminants of concern are selected for investigation in the risk assessment and includes a review of the chemicals that are potentially released to the atmosphere from the equipment of concern. As indicated, this assessment is limited to diesel particulate emissions from the main rail lines and vehicular

traffic. Emission factors of diesel particulate matter for these types of equipment were obtained from various sources as discussed below.

Diesel particulate matter emission factors for the rail line operations and on-road vehicles, as well as assessment of potential impacts due to these sources are considered and discussed separately below.

7.1.2 Dose-Response Assessment

The dose-response assessment develops relationships between exposures to a given chemical and the corresponding potential health effects associated with exposure to that chemical. In general, data are limited regarding adverse effects associated with direct exposure of humans to a particular chemical. Therefore, animal experiments have often been performed to assess a chemical's toxicity. These experiments are conducted to determine the organs that are adversely affected by a toxic chemical and the amount of chemical needed to produce an adverse effect.

Two types of adverse health effects are generally considered in health risk assessments: carcinogenic and non-carcinogenic. Non-carcinogenic effects, such as liver or kidney damage, may be either reversible or permanent. In these situations, it is assumed that there is a level of exposure at which these chemicals produce no adverse effects in the human body. In other words, exposure to these chemicals in amounts less than a threshold level will result in no adverse health effects.

Chemicals that potentially produce carcinogenic effects have been shown or are suspected to produce tumors in animals or humans. There are no threshold levels below which these chemicals are assumed not to have carcinogenic effects. Therefore, carcinogenic effects are assessed in terms of incremental or excess risks.

Toxicological properties and estimates of the dose-response relationships of the diesel particulate matter assessed in this risk assessment are provided by OEHHA and the CARB (State of California 2010d). For non-carcinogens, the Reference Exposure Level (REL) is identified. RELs represent a dose believed to be below the threshold for adverse non-carcinogenic health effects. For carcinogens, the cancer potency values (CPVs) are identified. The CPVs are expressed either as a "unit risk factor" [i.e., $(\mu\text{g}/\text{m}^3)^{-1}$] or as a "potency factor" in units of inverse dose as a potency slope [i.e., $(\text{mg}/\text{kg}\text{-day})^{-1}$]. The OEHHA guidance recommends the use of inhalation cancer potency factors instead of unit risk factors (State of California 2003b). Therefore, this assessment utilizes the inhalation cancer potency factor. Table 13 summarizes the dose-response values for diesel particulate matter.

TABLE 13
DIESEL PARTICULATE MATTER RISK DATA

Substance	Acute Inhalation ($\mu\text{g}/\text{m}^3$)	8-hour Inhalation ($\mu\text{g}/\text{m}^3$)	Chronic Inhalation ($\mu\text{g}/\text{m}^3$)	Chronic Oral (mg/kg-d)	Inhalation Unit Risk ($\mu\text{g}/\text{m}^3$) ⁻¹	Inhalation Cancer Potency Factor (mg/kg-d) ⁻¹	Oral Slope Factor (mg/kg-d) ⁻¹
Diesel Particulate	--	--	5.0E + 00	--	3.0E – 04	1.1E + 00	--

7.1.3 Exposure Assessment

The exposure assessment identifies potential exposure pathways, estimates chemical concentrations at potential exposure points, and calculates expected doses of emitted substances. An exposure pathway is defined as the means by which an individual or a population is exposed to contaminants that originate from a source. Each pathway represents a different mechanism for exposure.

Four elements must be present in order for a potential human exposure pathway to exist.

- A source and mechanism of substance release to the environment
- An environmental transport medium (e.g., air, water, soil)
- An exposure point, or point of potential contact with the contaminated medium
- A receiver (i.e., human) with a route of entry (e.g., inhaling air, drinking water) at the point of contact

The current risk assessment only considers substances that are released into the air and inhaled. It is noted that there are no designated agricultural uses within the plan area.

Ambient atmospheric concentrations resulting from emissions of diesel particulates are calculated using mathematical air dispersion models, which use emission rates and durations, design features specific to the emissions sources, and meteorological data. The air modeling results include annual average and hourly ambient air concentrations of the modeled substances at various receiver points. In order to evaluate human exposure, a human receiver with a route of exposure to the affected medium is required, such as a person inhaling air in a potentially affected area. Therefore, potential health risks are only evaluated for developed areas where humans typically are present. A quantitative estimate of potential human exposure is developed for the inhalation pathway in this study. All of the assumptions made for the exposure assessment are intended to overestimate the calculated health risk (i.e., to be “health conservative”).

7.1.4 Risk Characterization

Risk characterization is the process of combining dose-response information with the estimates of human exposure in order to derive a quantitative estimate of the likelihood that humans will experience any adverse health effects for the given exposure assumptions. As mentioned, two general types of health effects are generally considered: potential carcinogenic risks after chronic (long-term) exposure and potential non-carcinogenic health impacts following chronic and acute (short-term) exposure. For this assessment, only long-term carcinogenic and long-term non-carcinogenic (chronic) risks resulting from diesel particulate matter exposure are evaluated (acute health risks due to diesel particulate matter exposure have not been identified; see Table 13).

Typically, the potential risks are calculated at a given receiver for each emitted substance to estimate the individual risks associated with the release of each substance. The individual risks from each emitted substance are then combined to estimate the total potential health risks at that receiver. For the worst-case carcinogenic risk this receiver is a hypothetical maximally exposed individual (MEI) who is assumed to be exposed at a single location to the estimated maximum average concentrations of toxic chemicals emitted from a project for a 70-year lifetime. Using the hypothetical maximum off-site (i.e., outside of an emitting facility boundary) impact for the risk analysis provides a health-conservative, upper-bound risk estimate of off-site risks. The average person will not experience the high degree of exposure assumed for the maximum off-site impact.

For non-carcinogenic risks, the worst-case chronic risk is based on the estimated maximum average annual concentrations of toxic chemicals emitted from a project or facility.

The “zone of impact” is the geographic area potentially affected by emissions from a facility or project. A common definition of the zone of impact for carcinogenic risks is the area exposed to an estimated residential carcinogenic risk of one excess incidence per million exposed people (1×10^{-6}) and greater. For non-carcinogenic substances, the zone of impact is generally the area exposed to a maximum off-site hazard index of 0.5 and greater. The zone of impact does *not* define significant impact areas. Rather, these areas require a greater level of consideration.

Under Proposition 65, the State of California considers an incremental excess cancer risk of less than 10 in 1,000,000 (10^{-5}) for each toxic chemical to be acceptable for involuntary exposure. For AB-2588, agencies in California have commonly established 10 in 1,000,000 as the risk threshold for notification; this threshold applies to the summed risk from all compounds emitted from a facility. For chronic health hazard indices, a value of 1 or greater is generally considered to be significant for the sum of all chemicals that affect a particular toxicological endpoint.

The APCD has adopted these values for notification of a potential air quality impact from permitted facilities. Furthermore, the APCD uses these thresholds (with the implementation of Toxics Best Available Control Technology) for the issuance of permits without the need for satisfying additional conditions specified in APCD Rule 1200 Section (d)(1)(iii). Therefore, for this analysis, an incremental cancer risk of greater than or equal to 10 in 1,000,000 to the MEI for exposure to diesel particulate emissions is considered significant. A hazard index greater than or equal to 1 for any toxicological endpoint is considered significant for chronic non-carcinogenic impacts.

7.1.5 Calculation of Health Risks

As discussed, the exposure and risk assessment methodology used in this analysis follows the OEHHA Risk Assessment Guidelines (State of California 2003b) and supplemental guidance from the APCD (County of San Diego 2006).

Carcinogenic health risk is determined by calculating the lifetime average daily dose based on several exposure assumptions, some of which are:

- Residency time at the receiver point
- Daily respiration rate
- Average body weight
- Pollutant concentration for each medium (air, water, soil, etc.)
- Ingestion rate of contaminated soil (oral exposure only)
- Ingestion rate of contaminated water (oral exposure only)
- Ingestion rate of contaminated food products (oral exposure only)

The dose calculations use the conservative exposure assumptions as recommended by OEHHA. Once the exposure dose has been determined, the carcinogenic health risk is calculated by applying the compound's potency risk factor (PF). Total risk at a receiver is then determined by summing the pathway risks for each compound and then totaling the individual compound risks.

Potential non-carcinogenic health effects are evaluated by dividing each compound's modeled concentrations at each receiver by the REL to calculate an individual substance "hazard quotient." Overall, potential non-carcinogenic health effects at each receiver, for each toxicological endpoint, are then determined by taking the sum of the individual hazard quotients of each compound that impacts an endpoint to calculate the total endpoint hazard index.

The pollutant toxicity/carcinogenicity data used in this assessment are shown in Table 13. As indicated previously, air exposure is the only pathway considered in this analysis. For both carcinogenic and non-carcinogenic effects, the projected risks are reported for the point of maximum impact (PMI), the maximally exposed individual resident (MEIR), and the maximally exposed individual worker (MEIW).

Generally, health risk assessments evaluate the potential effects on the surrounding community due to operation of the facility under consideration. The PMI is defined as the receiver point(s) with the highest acute, chronic, or cancer health impacts outside of the facility boundary (defined as the property line). The MEIR is defined as the existing off-site residence(s) (e.g., house or apartment) with the highest acute, chronic, or cancer health impacts. The MEIW is defined as the highest acute, chronic, or cancer health impacts at an existing workplace off-site.

As noted, this assessment is not an evaluation of the potential effects associated with placing a polluting facility near sensitive uses. Rather, it is an evaluation of the potential effects associated with placing sensitive land uses in the vicinity of existing sources of air pollution. Therefore, this assessment evaluates the maximum potential health risk impacts (residential and worker) within the proposed CPU area due to these existing external sources.

As mentioned previously, acute health effects have not been associated with diesel particulate emissions. Therefore, this assessment only considers carcinogenic and chronic non-carcinogenic effects.

7.1.5.1 Carcinogenic Risk

Carcinogenic risk characterization estimates the probability that cancer will occur in an individual in a potentially exposed population. For the inhalation pathway, the exposure point inhalation dose ($D_{\text{OSE-INH}}$) of a toxic substance (in milligrams of dose per kilogram of body weight each day [mg/kg BW-day]) is multiplied by the cancer PF for that substance (in [mg/kg BW-day]⁻¹) to estimate the individual excess (incremental) cancer risk.

$$\text{individual excess cancer risk} = D_{\text{OSE-INH}} \text{ (mg/kg BW - day)} \times \text{PF (mg/kg BW - day)}^{-1}$$

The inhalation dose was calculated following the OEHHA guidance using the following equation (State of California 2003b):

$$D_{OSD-INH} = \frac{C_{AIR} * \{DBR\} * A * EF * ED * 10^{-6}}{AT}$$

where:

$D_{OSD-INH}$ = Dose through inhalation (mg/kg BW-day)

10^{-6} = Micrograms to milligrams conversion, Liters to cubic meters conversion

C_{AIR} = Concentration in air ($\mu\text{g}/\text{m}^3$)

{DBR} = Daily breathing rate $\left(\frac{L}{kg \text{ body weight} - \text{day}} \right)$

A = Inhalation absorption factor

EF = Exposure frequency (days/year)

ED = Exposure duration (years)

AT = Averaging time period over which exposure is averaged, in days (e.g., 25,550 for 70 year cancer risk)

The average annual concentration of diesel particulates at each modeled receiver was calculated using air dispersion models as discussed in the following sections. The recommended defaults were used for the other parameters as shown below (State of California 2003b):

EF = 350 days/year

ED = 70 years

AT = 25,550

A = 1

with the values for the daily breathing rate as shown in Table 14 (State of California 2003b, 2003c, 2008b).

**TABLE 14
POINT ESTIMATES FOR DAILY BREATHING RATE
FOR 9-, 30-, AND 70-YEAR EXPOSURE DURATIONS (DBR)
(L per kg body weight [BW] per day)**

9-Year Exposure Duration		30 & 70-Year Exposure Duration			Off-site Worker ¹
Average	High End	Average (65 th percentile)	80 th Percentile	High End (95 th percentile)	(Single Value)
452	581	271	302	393	149

¹This value corresponds to a 70 kg worker breathing 1.3 m³/hour for an eight-hour day. 1.3 m³/hr is the breathing rate recommended by EPA (U.S. EPA 1997; State of California 2003b) as an hourly average for outdoor workers.

Nine- and 30-year exposure durations are representative of typical residency periods for adults. Additionally, the parameters used for 9-year exposure scenarios are for the first 9 years of life, and are thus protective of children. However, it is required that all health risk assessments address the 70-year lifetime exposure duration. Further, while the breathing rates of children are greater than that of adults as indicated by the 9-year exposure duration DBR values in Table 14, the 70-year lifetime exposure risk represents the greatest risk overall. As such, this assessment evaluates adverse impacts based on the 70-year cancer risk. As seen in Table 14, there are three values given for the 70-year exposure daily breathing rate. These values are the mean (65th percentile), 80th percentile, and high end (95th percentile) breathing rates used to estimate the range of risk. The HRA guidance recommends that the risk for all three breathing rates be identified in the assessment (State of California 2003b, 2003c). The range of incremental cancer risks is discussed in this assessment.

However, it appears that the cancer risk contours in the rail yard studies discussed above in Section 4.5.2 were generated using the 80th percentile breathing rates. Using the 80th percentile breathing rate is consistent with CARB guidance (State of California 2008b):

“where a single cancer risk value (rather than a range of risk) is needed or prudent for characterizing risk or where a single risk value is used for (cancer) risk management decision-making for residential receptors.”

Therefore, for consistency in comparing results across studies, the discussion of residential incremental cancer risk in this assessment focuses on risks associated with the 80th percentile breathing rate.

The 70-year lifetime exposure is used to evaluate potential risks to residential areas. However, potential risks to commercial and on-site (i.e., within the emitting facility grounds) areas are more accurately reflected by worker exposure. In general, it is assumed that workers that are affected by facility emissions would be exposed 8 hours per day, 5 days per week, 49 weeks per year, for 40 years (State of California 2003b; County of San Diego

2006). As indicated in Table 14, a worker is assumed to breathe 149 L/kg BW—day for an 8-hour workday. With these exposure adjustments, the adjustment factors shown in Table 15 were applied to the 70-year residential inhalation excess cancer risk estimates to obtain the worker inhalation incremental cancer risk estimate.

**TABLE 15
ADJUSTMENT FACTORS TO CONVERT INHALATION-BASED CANCER RISK ESTIMATES FOR
A RESIDENTIAL RECEIVER TO A WORKER RECEIVER**

Worker Receiver Type (Hrs/Days/Weeks/Years)	Facility Operating Schedule (Hrs/Days/Weeks/Years)	Adjustment Factor	
		(High End)*	(Average)*
8/5/49/40	Continuous (24/7/52/70)	0.1516	0.2199
8/5/49/40	Standard (8/5/52/70)	0.6366	0.9234

*High End adjustment factors convert the residential receiver risk based on the high-end breathing rate point-estimate to a worker receiver risk. Average adjustment factors convert the residential receiver risk based on the average breathing rate point-estimate to a worker receiver risk.

(Note: there is no equivalent worker reduction for evaluating chronic risk). The surrounding sources were treated as continuous operations.

Using the information above, the factors shown in Table 16 were developed that were then multiplied by the modeled average annual diesel particulate matter concentrations in order to calculate the risk at each receiver in incremental cancers per million.

**TABLE 16
INCREMENTAL CANCER RISK DIESEL PARTICULATE MATTER
CONCENTRATION MULTIPLICATION FACTORS
(m³/µg)**

30- & 70-Year Exposure Duration			Off-site Worker ¹ (Single Value)
Average (65 th percentile)	80 th Percentile	High End (95 th percentile)	
285.85	318.55	414.53	62.86

At each modeled receiver, the total lifetime incremental cancer risk is calculated by summing the cancer risks from all substances analyzed (in this case only diesel particulates). The incremental cancer risk is the likelihood (above the background cancer rate in the general population) that an individual will develop cancer during his or her lifetime as a result of exposure to a substance. The incremental cancer risk is expressed as a probability. For example, a risk of 10 in 1,000,000 (1×10^{-5}) means that, within an exposed population subject to the assumptions presented in the exposure assessment section, 10 additional individuals in one million would be expected to develop cancer during his or her lifetime. In other words, an individual would have an increased risk of 1 in 100,000 of getting cancer in their lifetime.

7.1.5.2 Chronic Non-carcinogenic Health Effects

Chronic (long-term) non-carcinogenic risk characterization is performed by comparing the estimated annual air concentration of the substance (C_{ANN}) with an REL. For each substance, the average annual concentration is divided by the REL to determine a chronic hazard quotient.

$$\text{chronichazardquotient} = \frac{C_{ANN}(\mu\text{g}/\text{m}^3)}{\text{REL}(\mu\text{g}/\text{m}^3)}$$

The hazard index, which provides a measure of total potential chronic non-carcinogenic health effects, is calculated for each receiver by summing the hazard quotients for all individual substances that impact the same toxicological endpoint. Again, for this study only inhalation of diesel particulate matter is considered. According to general risk policy, when an individual hazard quotient is less than or equal to one, the chronic REL has not been exceeded and no adverse chronic non-carcinogenic health effects are expected from that substance. Similarly, if the hazard index is greater than one, chronic non-carcinogenic effects resulting from exposure to the substances emitted may be possible.

7.2 Freeway Diesel Emissions

7.2.1 Methodology

A health risk assessment was performed to consider the potential effects of placement of various land uses near I-5, SR-15, and SR-75 (refer to Figures 3a–3c). This analysis includes calculation of potential incremental cancer risks and chronic health hazard indices resulting from exposure to diesel particulates produced by vehicles on the freeways.

The calculation first involves generation of diesel particulate composite emission factors for the vehicle fleet on the freeways using the EMFAC2007 program (State of California 2006b). Diesel particulate emissions were assumed to be equal to the PM_{10} exhaust emissions from diesel powered vehicles. Emission factors were calculated for annual average conditions of 64 °F and 70 percent humidity. Other default parameters provided by the model for the SDAB were used in the calculation of individual emission factors for each type of vehicle in the fleet.

Using the individual vehicle emission factors, diesel particulate matter composite emission rates were then generated, which assumed 1.87 percent of traffic as diesel-emitting. An assumption of 1.87 percent traffic on the freeways being diesel-emitting was the year 2030 fleet average in EMFAC2007 and was based on an analysis of Department of Motor Vehicles (DMV) registration data (State of California 2006b). The average traffic speed for I-5 was assumed to be 65 miles per hour (mph); the average traffic speed for the transition

ramps (SR-75 and SR-15) and for SR-75 beyond the transition ramps was assumed to be 50 mph. The resulting composite emission factors were 0.00303 g/mile at 50 mph and 0.00415 g/mile at 65 mph. The EMFAC2007 output is contained in Attachment 3.

These emission factors were then applied to the vehicles using the freeway and the resulting emissions were dispersed using the CALINE4 dispersion model (State of California 1989b). The CALINE4 model results in predicted concentrations of diesel particulates at modeled locations throughout the community. It is a line source dispersion model that does not specifically address topographic variability or intervening structures (e.g., flat site topography was assumed).

Future traffic volumes for I-5, SR-75, and SR-15 were obtained from the Traffic Impact Analysis prepared for the proposed CPU (Kimley–Horn and Associates 2011; Addendum 2012). The year 2030 I-5 traffic volume varies between 221,600 and 262,100 average daily traffic (ADT) depending on the freeway segment and alternative. The year 2030 SR-75 total traffic volume varies between 89,800 and 93,500 ADT depending on the alternative. The SR-75 traffic volumes were distributed between the various transition ramps near I-5. The year 2030 SR-15 total traffic volume varies between 129,700 and 130,800 ADT depending on the alternative. The SR-15 traffic volumes were distributed between the various transition ramps near I-5. The average annual hourly traffic volume was assumed to be the ADT divided by 24. The width of the roadways was taken to be the approximate average width of the traveled roadway plus 3 meters on either side per the CALINE4 manual (State of California 1989b).

As discussed in more detail in Section 7.4.2, per the EPA's *Guideline on Air Quality Models* (40 CFR 51 Appendix W § 8.3.1.2), five sequential years of meteorological data were used in the risk assessment. Wind direction, speed, and frequency for the 5-year period from 2006 through 2010 were taken into account based on a wind rose developed for Lindbergh Field surface wind data. This information included direction and strength. The wind rose is shown in Figure 19. Table 17 provides the angles, average speeds, and relative durations of the wind used in the analysis. Separate CALINE4 runs were made for each 22.5 degree wind angle. Additional assumptions used in the CALINE4 dispersion model are provided in Attachment 4.

TABLE 17
WIND DIRECTION AND RELATIVE DURATION

Wind Direction	Angle	Average Wind Speed (meters/second)	Relative Duration (%)
N	0.0	1.8	6.72
NNE	22.5	1.8	4.26
NE	45.0	1.8	2.62
ENE	67.5	1.8	1.69
E	90.0	2.0	2.13
ESE	112.5	2.4	1.58
SE	135.0	2.7	1.01
SSE	157.5	3.7	3.29
S	180.0	3.4	8.18
SSW	202.5	3.3	7.25
SW	225.0	3.6	7.24
WSW	247.5	3.5	3.82
W	270.0	3.8	6.93
WNW	292.5	4.0	22.55
NW	315.0	3.1	10.44
NNW	337.5	2.2	7.11
Calm	n/a	n/a	3.18

Calculations were made for a grid of receivers throughout the community. The receivers were spaced 25 meters apart and extend out to 1/3 of a mile beyond the plan area boundary as shown in Figure 20. Figure 20 also indicates the modeled freeway segments for Alternative 1 and Revised Alternative 2. Traffic volumes were not provided for the transition ramps for the adopted community plan; thus for the adopted community plan only the freeway main lines were modeled as shown in Figure 21.

As indicated, at each receiver for each modeled wind angle the diesel particulate concentration was calculated. The individual wind angle concentrations were then weighted for the relative duration of the wind and combined to develop the total diesel particulate concentration at each modeled location. Based on the modeled concentrations, the incremental cancer risk per million and the chronic health hazard index were determined for each modeled receiver using the factors described above.

Attachment 5 includes the CALINE4 input and output files for the adopted land use plan. Attachment 6 includes the CALINE4 input and output files for proposed CPU land use Alternative 1. Attachment 7 includes the CALINE4 input and output files for proposed CPU land use Revised Alternative 2.

7.2.2 Results

As indicated, at each receiver for each 22.5 degree wind angle, a diesel particulate concentration was calculated, weighted for the relative duration of the wind and combined with all of the other wind angle concentrations to develop the total average annual diesel particulate concentration at the receiver. The total concentration was then used to calculate the incremental cancer risk and chronic health hazard index at each modeled location. The carcinogenic and chronic risk calculations for each alternative are contained in Attachment 8.

7.2.2.1 Carcinogenic Risk

Figure 22 shows the residential incremental cancer risk isopleths based on the 80th percentile breathing rate plotted on the adopted plan land uses. Figure 23 shows the residential incremental cancer risk isopleths based on the 80th percentile breathing rate plotted on the proposed CPU Alternative 1 land uses. Figure 24 shows the residential incremental cancer risk isopleths based on the 80th percentile breathing rate plotted on the proposed CPU Revised Alternative 2 land uses. The results indicate that all but a small portion of the plan area is exposed to an incremental cancer risk of greater than 10 in one million due to diesel particulate emissions from the freeways. The risk drops off relatively quickly as one moves away from the freeways, but exceeds 50 in one million adjacent to the freeways.

The average residential incremental cancer risk would be 10.3 percent less than that shown in Figures 22, 23, and 24; the high-end residential incremental cancer risk would be 30.1 percent greater than that shown in Figures 22, 23, and 24. Figure 22 also shows the location of the MEIR for the adopted plan land uses. At this location the average residential incremental cancer risk due to diesel particulates from the freeways is 81.0 in one million; the 80th percentile risk is 90 in one million; and the high-end risk is 117 in one million. Figure 23 also shows the location of the MEIR for the proposed CPU Alternative 1 land uses. At this location the average residential incremental cancer risk due to diesel particulates from the freeways is 75 in one million; the 80th percentile risk is 84 in one million; and the high-end risk is 109 in one million. Figure 24 also shows the location of the MEIR for the proposed CPU Revised Alternative 2 land uses. At this location the average residential incremental cancer risk due to diesel particulates from the freeways is 75 in one million; the 80th percentile risk is 84 in one million; and the high-end risk is 109 in one million.

Figure 25 shows the worker incremental cancer risk isopleths plotted on the adopted plan land uses. Figure 26 shows the worker incremental cancer risk isopleths plotted on the proposed CPU Alternative 1 land uses. Figure 27 shows the worker incremental cancer risk isopleths plotted on the proposed CPU Revised Alternative 2 land uses. The results indicate that the majority of the plan area lies outside of the 10 in one million incremental cancer risk contour due to diesel particulate emissions from the freeways, although the risk does

exceed 10 in one million adjacent to the freeways. Figure 25 also shows the location of the MEIW for the adopted plan land uses. At this location the worker incremental cancer risk due to diesel particulates from the freeways is 28 in one million. Figure 26 also shows the location of the MEIW for the proposed CPU Alternative 1 land uses. At this location the worker incremental cancer risk due to diesel particulates from the freeways is 17 in one million. Figure 27 also shows the location of the MEIW for the proposed CPU Revised Alternative 2 land uses. At this location the worker incremental cancer risk due to diesel particulates from the freeways is 17 in one million.

It should be reminded that incremental cancer risk is calculated assuming a 24-hour-per-day-70-year-lifetime exposure. The assessment also does not account for significant mobile source emission reductions mandated to occur by State and federal regulations over the next 10 years per the diesel particulate reduction plan (State of California 2000).

Although there is no adopted standard for evaluating the impacts due to emissions from mobile sources, such as vehicles traveling the freeways, as discussed in Section 5.5 the commonly used incremental cancer risk threshold of 10 in one million was used as the threshold of significance in this assessment. Thus, based on this threshold, the effects detailed above are considered to be significant.

The only means of reducing these effects is the implementation of source controls and to avoid locating new sensitive land uses within the 10 in one million contours. It is noted that the CARB Air Quality and Land Use Handbook (State of California 2005) recommends avoiding siting new sensitive receivers within 500 feet of freeways and heavily traveled urban roads. However, based on the analysis above, even at 500 feet from the freeways the incremental cancer risk exceeds 10 in one million.

The CARB has worked on developing strategies and regulations aimed at reducing the risk from diesel particulate matter. The overall strategy for achieving these reductions is found in the "Risk Reduction Plan to Reduce Particulate Matter Emissions from Diesel-Fueled Engines and Vehicles" (State of California 2000). A stated goal of the plan is to reduce the cancer risk statewide arising from exposure to diesel particulate matter 75 percent by 2010 and 85 percent by 2020. A number of programs and strategies to reduce diesel particulate matter have been or are in the process of being developed including the Diesel Risk Reduction Program which aims to reduce diesel particulate emissions through improved automobile design and alternative fuel efficiency (State of California 2000).

7.2.2.2 Chronic Risk

An assessment of the potential chronic risk due to diesel particulate emissions from the freeway was made at the same receivers throughout the community as discussed above for the carcinogenic risk. The results of the analysis indicate that the worst-case chronic health hazard index due to diesel particulate emissions from the freeways for all alternatives is approximately 0.17 or less. At all locations within the community the chronic health hazard

index is less than one. Therefore, this represents a less than significant chronic health impact.

7.3 Truck Route Diesel Emissions

7.3.1 Methodology

A health risk assessment was also performed to consider the potential diesel particulate health effects resulting from placement of various land uses along the proposed truck routes shown on proposed CPU land use Alternative 1 and Revised Alternative 2. The proposed truck routes are the same for both proposed CPU alternatives and are shown in Figure 28. The analysis only considers truck traffic on the proposed truck routes and used essentially the same methodology as that for the freeways with specific assumptions as follows.

The analysis first involved generation of emissions factors for diesel particulates using the EMFAC2007 program. Emission factors were calculated for annual average conditions of 64° F and 70 percent humidity as for the freeway analysis discussed above. Other default parameters provided by the model for the SDAB were used in the calculation of individual emission factors for each type of vehicle in the fleet. To be conservative, it was assumed that 100 percent of the truck traffic on the truck routes consisted of heavy-heavy-duty diesel trucks. As seen in Figure 28, four roadways were considered in the analysis: Harbor Drive, 28th Street, 32nd Street, and Wabash Boulevard. The average truck speeds for these roadways were assumed to be 40 mph, 30 mph, 35 mph, and 40 mph, respectively. The EMFAC2007 output is contained in Attachment 3.

These emission factors were then applied to the trucks using the proposed truck routes and dispersed using the CALINE4 dispersion model. Future truck volumes for the roadways were obtained from the Traffic Impact Analysis prepared for the proposed CPU (Kimley–Horn and Associates 2011; Addendum 2012). For Harbor Drive, 32nd Street and Wabash Boulevard the future truck volumes are the same for both proposed CPU land use Alternative 1 and Revised Alternative 2. For Harbor Drive the year 2030 truck volume varies between 100 and 1,325 ADT depending on the roadway segment, and for both 32nd Street and Wabash Boulevard the year 2030 truck volume is 740 ADT. For 28th Street the year 2030 truck volume is 495 ADT for proposed CPU land use Alternative 1 and 645 ADT for proposed CPU land use Revised Alternative 2.

The same wind data were used for the truck route dispersion analysis as for the freeway analysis. Calculations were made for the same receiver grid as in the freeway analysis. As with the freeway analysis, at each receiver for each modeled wind angle the average annual diesel particulate concentration was calculated. The individual wind angle concentrations were then weighted for the relative duration of the wind and combined to develop the total diesel particulate concentration at each modeled location. Based on the modeled

concentrations, the incremental cancer risk per million and the chronic health hazard index were determined for each modeled receiver using the factors described above.

Attachment 9 includes the CALINE4 input and output files for proposed CPU land use Alternative 1. Attachment 10 includes the CALINE4 input and output files for proposed CPU land use Revised Alternative 2.

7.3.2 Results

As indicated, at each receiver for each 22.5 degree wind angle, an average annual diesel particulate concentration was calculated, weighted for the relative duration of the wind and combined with all of the other wind angle concentrations to develop the total diesel particulate concentration at the receiver. The total concentration was then used to calculate the incremental cancer risk and chronic health hazard index at each modeled location. The carcinogenic and chronic risk calculations for each alternative are contained in Attachment 11.

7.3.2.1 Carcinogenic Risk

Figure 29 shows the residential incremental cancer risk isopleths based on the 80th percentile breathing rate plotted on the proposed CPU Alternative 1 land uses. Figure 30 shows the residential incremental cancer risk isopleths based on the 80th percentile breathing rate plotted on the proposed CPU Revised Alternative 2 land uses. The results indicate that much of the plan area under the City's jurisdiction is located outside of the 10 in one million incremental cancer risk contour due to diesel particulate emissions from the truck routes. However, a substantial portion of the lands under the City's jurisdiction are within the 10 in one million contour.

The average residential incremental cancer risk would be 10.3% less than that shown in Figures 29 and 30; the high-end residential incremental cancer risk would be 30.1 percent greater than that shown in Figures 29 and 30. Figure 29 also shows the location of the MEIR for the proposed CPU Alternative 1 land uses. At this location the average residential incremental cancer risk due to diesel particulates from the truck routes is 18 in one million; the 80th percentile risk is 20 in one million; and the high-end risk is 26 in one million. Figure 30 also shows the location of the MEIR for the proposed CPU Revised Alternative 2 land uses. At this location the average residential incremental cancer risk due to diesel particulates from the truck routes is 19 in one million; the 80th percentile risk is 22 in one million; and the high-end risk is 28 in one million.

Figure 31 shows the worker incremental cancer risk isopleths plotted on the proposed CPU Alternative 1 land uses. Figure 32 shows the worker incremental cancer risk isopleths plotted on the proposed CPU Revised Alternative 2 land uses. The results indicate that the majority of the plan area lies outside of the 10 in one million incremental cancer risk contour

due to diesel particulate emissions from the truck routes, although the risk does exceed 10 in one million immediately adjacent to portions of the truck routes. Figure 31 also shows the location of the MEIW for the proposed CPU Alternative 1 land uses. At this location the worker incremental cancer risk due to diesel particulates from the truck routes is 13 in one million. Figure 32 also shows the location of the MEIW for the proposed CPU Revised Alternative 2 land uses. At this location the worker incremental cancer risk due to diesel particulates from the truck routes is 13 in one million.

As with the freeways, there is no adopted standard for evaluating the diesel particulate emission impacts due to the trucks traveling the truck routes. Therefore, the significance threshold of 10 in one million used in the freeway assessment was used in evaluating the potential impacts from the truck routes. Thus the effects detailed above are considered to be significant. The only means of reducing these effects is the implementation of source controls and to avoid locating new sensitive land uses within the 10 in one million contours. The State diesel particulate emission reduction activities discussed above are also aimed at reducing emissions from trucks.

7.3.2.2 Chronic Risk

An assessment of the potential chronic risk due to diesel particulate emissions from the truck routes was made at the same receivers throughout the community as discussed above for the carcinogenic risk. The results of the analysis indicate that the worst-case chronic health hazard index due to diesel particulate emissions from the truck routes for both proposed CPU alternatives is approximately 0.06 or less. At all locations within the community the chronic health hazard index is less than one. Therefore, this represents a less than significant chronic health impact.

7.4 Train Diesel Emissions

The potential health risks associated with diesel particulate emissions from the rail line operations were assessed following the four-step assessment process discussed above in Section 7.1. Rail line operations within and adjacent to the plan area are currently conducted by three separate entities: the Burlington Northern-Santa Fe Railway (BNSF), the San Diego and Imperial Valley Railroad (SDIY), and the Metropolitan Transit System (MTS). The MTS operates light rail (trolley) service on the “Blue” and “Orange” Lines through and adjacent to Barrio Logan. The trolleys are electric and do not emit diesel particulate matter. The BNSF is a Class I railroad that provides freight service throughout much of the country. The BNSF San Diego Railyard is located to the northwest of the Barrio Logan community planning area and operates regular freight service through Barrio Logan to the South Bay. The SDIY is a short-line railroad that provides a connection from the BNSF in San Diego to the Mexican border at San Ysidro, as well as service from San Diego to El Cajon. The SDIY trains use

the MTS “Blue” and “Orange” Lines when the trolleys are not running. The general locations of these lines in the Barrio Logan area are shown in Figure 33.

As discussed in Section 4.5.2.3, an HRA was prepared for the BNSF San Diego Railyard. This study did not include rail activities on the main lines north or south of the rail yard (ENVIRON 2008b), but did model all assumed main line operations within the yard (south to approximately Cesar E. Chavez Parkway). The current assessment focuses on the main line operations south of the yard. Therefore, for the BNSF, rail activities were modeled on the assumed BNSF main lines stretching from approximately Cesar E. Chavez Parkway on the west to near West 8th Street in National City on the east (at which point the rail line is more than ¼ mile from the planning area boundary; see Figure 34).

As discussed in Section 4.5.2.1, the CARB has posted on its website a Draft HRA prepared for the SDIY yard in 2005 (SD Freight Rail Consulting 2005). The assessment evaluated activities in the SDIY San Diego yard, but presumably did not include activities on the main lines beyond the yard. Therefore, for the SDIY trains to/from San Ysidro, rail activities were modeled on the assumed SDIY main line (MTS “Blue” Line) stretching from approximately Park Boulevard on the west (near the BNSF interchange) to near West 8th Street in National City on the east (at which point the rail line is more than ¼ mile from the planning area boundary). For the SDIY trains to/from El Cajon, rail activities were modeled on the assumed SDIY main line (MTS “Orange” Line) stretching from approximately Park Boulevard on the west (near the BNSF interchange) to approximately 25th Street on the east (at which point the rail line is more than ¼ mile from the planning area boundary; see Figure 34).

The following discusses the specifics of the current assessment.

7.4.1 Emission Estimates

Table 18 indicates the typical locomotive models that are involved in the regular rail activities through the area.

**TABLE 18
LOCOMOTIVES MODELED**

Railroad	Engine Model Number Used
BNSF ¹	EMD GP60M GE ES44DC
SDIY ²	EMD SW 1500 NRE 3GS21B Gen-Sets

Sources: ¹ Phillips, per. com. 2011a

² Domen, per. com. 2011a

EMD—General Motors Electro-Motive Division

GE—General Electric

NRE—National Railway Equipment

Table 19 shows the assumed rail activities for the BNSF and SDIY through the Barrio Logan community.

**TABLE 19
RAIL LINE OPERATIONS**

Railroad	Trips Per Week	Trips Per Year	Time of operation	Engine Model Number	Number of Engines per Train
BNSF	1 round trip "local" to National City 5 days per week ¹	1 round trip 261 days per year	Monday–Saturday (on average) 0630–2300 ¹	GP-60	2 ³
BNSF	1 roundtrip vehicle train to National City 4 days per week ¹	1 round trip approximately 209 days per year	Monday–Saturday (on average) 1700–0630 ¹	ES44DC	4 ³
SDIY	1 round trip to Mexican border (San Ysidro) 5 days per week ²	1 round trip 261 days per year	Sunday–Thursday 0100–0400 ²	SW1500/3GS21B	1–2 ^{4,5}
SDIY	1 round trip to El Cajon 2 days per week ⁵	1 round trip 104 days per year	Normally Sunday and Wednesday 0130–0400 ⁵	SW1500/3GS21B	1 ⁵

Source: ¹Phillips, per. com. 2011a,b; ²Domen, per. com. 2011b; ³Phillips, per. com. 2011c; ⁴Domen, per. com. 2011c; ⁵Domen, per. com. 2011d

Locomotive use was obtained directly from the respective rail line operators. The BNSF "local" train is assumed to use 2 GP60Ms, while the BNSF "vehicle" train is assumed to use 4 ES44DCs (Phillips, pers. com. 2011b, c).

For the SDIY trains, in general only one locomotive is used on each train (Domen, per. com. 2011c). However, the San Ysidro train is generally longer than the El Cajon train and on occasion the additional tonnage requires the use of two locomotives. Based on emissions data provided in both the BNSF San Diego Rail Yard Study and by the SDIY, it was observed that the SW1500 generally has greater particulate matter emissions than does the 3GS21B (ENVIRON 2008a; Flurry, per. com. 2011). As noted in Table 19, on Sundays and Wednesdays operations occur simultaneously on both the San Ysidro and El Cajon lines. The SDIY has only one SW1500 and two 3GS21Bs. Thus on any given day the SW1500 could only operate on either the San Ysidro or El Cajon line. However, to be conservative since any locomotive could end up on either train, for this analysis it is assumed that the El Cajon train uses the SW1500, while the San Ysidro train uses the SW1500 and one 3GS21B. This results in the worst-case emissions.

For the BNSF, the project traffic engineer has indicated that the trains running through Barrio Logan have a timetable speed of 10 mph (Espelet 2010). For the SDIY, the permitted speed in and out of the SDIY yard is 5 mph (Domen, per. com. 2011d). The slower the

speed the longer the trains will be emitting pollutants into the Barrio Logan area. Therefore, to be conservative, a train speed of 5 miles per hour for all trains is assumed in this analysis.

Locomotives operate over a range of throttle settings generally referred to as “notches” that range from “Idle” to “Notch 8.” Larger throttle notch settings result in greater emission rates. Based on information provided in the Roseville study, 5 mph could be associated with throttle settings of up to Notch 2 (State of California 2004b Appendix C). Therefore, it is conservatively assumed that the trains operate continuously in Notch 2.

Diesel particulate matter emissions for the BNSF locomotives were obtained from an emissions inventory prepared for the BNSF San Diego rail yard (ENVIRON 2008a). It is assumed that the BNSF locomotives that operate on the main line are made up of the same fleet as the general BNSF locomotive fleet assessed in the rail yard study. Therefore, the emission factors assuming a 0.105% diesel fuel sulfur content were used (ENVIRON 2008a). Because the fuel composition for the SDIY engines was not provided, the more conservative emission factors for a switcher (SW1500) assuming a diesel fuel sulfur content of 0.3% were assumed for the SDIY SW1500 (ENVIRON 2008a). The emission factors for the 3GS21Bs were obtained from the SDIY (Flurry, per. com. 2011). Table 20 summarizes the diesel particulate emission factors used for each of the locomotives in this study.

**TABLE 20
LOCOMOTIVE DIESEL PARTICULATE MATTER EMISSION FACTORS
[Throttle Notch 2]**

Engine	Emission Factor (g/hr)
SW1500 ¹	76.0
3GS21B ²	33.9
GP60M ¹	75.5
ES44DC ¹	145.8

Source: ¹ENVIRON 2008a; ²Flurry, pers. com. 2011

Based on these emission factors, the number of locomotives per train, the assumed speed of 5 mph, and the length of the rail lines studied, the total diesel particulate matter emissions were calculated for each round trip and are summarized in Table 21.

TABLE 21
TRAIN DIESEL PARTICULATE MATTER EMISSIONS
[Throttle Notch 2]

Train	Total Emissions per Round Trip (g)	Window of Hours of Operation	Duration Window of Operation (hours)	Trains per Week	On Potential Days Per Week	Average Emission Rate during Potential Hours of Operations (g/s)
BNSF Vehicle	590.5	1700–0630	13.5	4	5 ^a	9.720E-03
BNSF “Local”	152.9	0630–2300	16.5	5	6 ^b	2.145E-03
SDIY San Ysidro	144.5	0100–0400	3.0	5	5 ^c	1.338E-02
SDIY El Cajon	30.0	0130–0400	2.5	2	2 ^d	3.337E-03

^aMonday evening–Saturday morning; ^bMonday–Saturday; ^cSunday–Thursday; ^dSunday & Wednesday

The AERMOD model (discussed below) only takes emission factors on an hourly basis. Therefore, to be conservative the potential hours of operation for each train were rounded to the next whole hour (e.g., in the model the BNSF vehicle train hours of operation were assumed to be 1700–0700) and the average emission rates shown in Table 21 were assumed to occur over the entire adjusted period.

7.4.2 Atmospheric Dispersion Modeling of Toxic Emissions

Version 11103 of the EPA-approved American Meteorological Society/EPA Regulatory Model (AERMOD) was used for the air dispersion modeling (U.S. EPA 2004b, 2011b). AERMOD is the successor to the EPA’s Industrial Source Complex (ISC) model for use in regulatory modeling applications per the EPA’s *Guideline on Air Quality Models* (Guideline), published as Appendix W to Title 40 of the Code of Federal Regulations, Part 51 (40 CFR 51 Appendix W).

The AERMOD model allows modeling of point, area, and volume sources. It utilizes detailed meteorology and includes various regulatory options including stack-tip downwash, a routine for processing averages when calm winds or missing meteorological data occur, consideration of building downwash, and elevated terrain. The following provides discussion of specific inputs to the AERMOD model.

7.4.2.1 Meteorological Data

The AERMOD model uses a file of surface boundary layer parameters (surface data) and a file of atmospheric profile variables including wind speed, wind direction, and turbulence parameters (upper air data). Upper air data are generally collected at fewer stations than surface data as upper air data are less influenced by local surface features. The Guideline (40 CFR 51 Appendix W § 8.3.1.2) specifies that generally five sequential years of data should be used in the risk assessment.

The National Weather Service (NWS) station nearest the project site that collects upper air data is at the Miramar Marine Corps Air Station (Miramar MCAS). It was determined that the NWS station nearest the project site for which good quality surface data were available is the Lindbergh Field station (Hammer per. com. 2011). Figure 35 shows the proximity of these stations to the proposed CPU area. Processed data, suitable for use in AERMOD, for the years 2006 through 2010 (the most recent years with consistent data available) were obtained for the Miramar MCAS and Lindbergh Field stations from Trinity Consultants, Inc. A wind rose of the surface data was created using the WRPLOT View software from Lakes Environmental Software (2011) for this five-year period and is shown in Figure 19. The processed surface data obtained from Trinity Consultants were developed using 1-minute Automated Surface Observing System (ASOS) wind data and version 11059 of the AERMOD Meteorological Preprocessor (AERMET) program (U.S. EPA 2004c, 2011c).

7.4.2.2 Urban/Rural Dispersion Coefficients

The AERMOD model has the ability to incorporate the effects of increased surface heating from urban areas on pollutant dispersion under stable atmospheric conditions. The decision whether to use urban or rural dispersion coefficients is determined using the EPA's Guideline.

Per the Guideline (40 CFR 51 Appendix W § 7.2.3):

- b. The selection of either rural or urban dispersion coefficients in a specific application should follow one of the procedures suggested by Irwin (1978) and briefly described in paragraphs (c)–(f) of this subsection. These include a land use classification procedure or a population based procedure to determine whether the character of an area is primarily urban or rural.
- c. Land Use Procedure: (1) Classify the land use within the total area, A_0 , circumscribed by a 3 km radius circle about the source using the meteorological land use typing scheme proposed by Auer (1978); (2) if land use types I1, I2, C1, R2, and R3 account for 50 percent or more of A_0 , use urban dispersion coefficients; otherwise, use appropriate rural dispersion coefficients.

- d. Population Density Procedure: (1) Compute the average population density, \bar{p} per square kilometer with A_0 as defined above; (2) If \bar{p} is greater than 750 people/km², use urban dispersion coefficients; otherwise use appropriate rural dispersion coefficients.
- e. Of the two methods, the land use procedure is considered more definitive. Population density should be used with caution and should not be applied to highly industrialized areas where the population density may be low and thus a rural classification would be indicated, but the area is sufficiently built-up so that the urban land use criteria would be satisfied. In this case, the classification should already be “urban” and urban dispersion parameters should be used.
- f. Sources located in an area defined as urban should be modeled using urban dispersion parameters. Sources located in areas defined as rural should be modeled using the rural dispersion parameters. For analyses of whole urban complexes, the entire area should be modeled as an urban region if most of the sources are located in areas classified as urban.

As seen in Figure 36 the area in and around the planning area is highly urbanized.

Population data by census block for the area were obtained from SanGIS (2003 [the most recent detailed census block data available at the time of this analysis]). Because the project is a large planning area rather than a single facility, as shown in Figure 36 a 3-km buffer was drawn around the Barrio Logan planning area boundary (which includes the modeled rail lines). Figure 36 also shows the census blocks that are within 3 km of the planning area boundary. Population data for partial census blocks are not available. Therefore, in Figure 36, census blocks are distinguished between those entirely contained within the 3 km buffer, and those that are partially contained within the 3 km buffer. Using just those census blocks that are entirely within the 3 km buffer results in a calculated population density of approximately 4,257 people/km². Adding in the census blocks that are partially within the 3 km buffer decreases the calculated population density to 1,784 people/km², although it is noted that much of this additional area is open water. The more conservative 1,784 people/km² is still greater than 750 people/km². Therefore, the use of urban dispersion coefficients is appropriate.

When using urban dispersion coefficients, an input to AERMOD is the population of the urban area. Figure 37 shows the parcels in the project region that have a density of at least 750 people/km². Using guidance in the AERMOD Implementation Guide, the urban population input parameter was determined by estimating the area of continuous urban features (primarily determined by the guideline density of 750 people/km²). Figure 37 shows the continuous urban area assumed for the model. The total population of this area is

1,629,283 (SanGIS 2003) and is consistent with the total population used in the San Diego Railyard study (State of California 2008a). This value was used in the AERMOD model.

7.4.2.3 Source Configuration

Consistent with the guidance, the locomotive emissions were modeled as a series of volume sources (State of California 2006a). Beyond the SDIY yard the trains travel on either the MTS “Blue” Line to San Ysidro, or on the MTS “Orange” Line to El Cajon. These lines are double tracked and it is assumed that the freight trains could travel on either track. Therefore, in order to reduce the complexity of the model and decrease the number of modeled volume sources consistent with other guidelines and studies, the length of the sides of each volume source was set equal to the combined width of the rail lines plus the width of an average locomotive (taken to be approximately 10 feet). This results in a width of approximately 24 feet. Within the yard the trains could utilize a number of lines. However, because a prior study has been prepared for the yard as discussed in Section 4.5.2.1 above (SD Freight Rail Consulting 2005), for this assessment it was assumed that the trains would continue generally on one of two rail lines through the yard. Thus the sides of each volume source for all of the SDIY movements were kept at a consistent 24 feet. Figure 34 shows the location of the modeled SDIY lines.

North of the BNSF yard there are two main lines into the yard. As with the SDIY yard, trains moving through the BNSF yard may utilize a number of lines. In general there also are two main rail lines leaving the BNSF yard to the south. While there are a number of sidings and spurs along these main lines, these two main lines run for approximately one-quarter mile after which the main line become single tracked. As discussed previously, because the prior study performed on the BNSF yard included the main line operations within the yard, this study only considers the movements south of Cesar E. Chavez Parkway. Therefore, for approximately one-quarter mile south of Cesar E. Chavez Parkway it is assumed that the trains may operate on either of the two lines and the length of the sides of each volume source for this segment was set to the width of the rail lines plus the width of an average locomotive, or 24 feet as described above for the SDIY. South of this point, although sidings and spurs continue to come off and/or run along the main line, the remainder of the rail line is modeled as a single track. For this portion of the rail line the length of the sides for each volume source was set equal to the width of an average locomotive, or approximately 10 feet. Figure 34 shows the location of the modeled BNSF lines.

Given the relatively small size and complexity of the study, the rail lines were represented by adjacent volume sources as described in the AERMOD and ISC User’s Guides (U.S. EPA 2004b 1995a). Figure 38 illustrates a portion of the adjacent volume sources in the area where the BNSF main line transitions from single to double track.

When modeling volume sources, AERMOD does not calculate the initial plume rise due to momentum and buoyancy effects. Therefore, as with the Roseville study, the initial release height for the moving locomotive exhaust plume was adjusted to account for the initial momentum and buoyancy plume rise using Version 96043 of the EPA's SCREEN3 model (State of California 2004b; U.S. EPA 1995b).¹¹

Figure 39 illustrates the locomotive exhaust plume rise. The plume release height was taken to be the sum of the final plume rise and the height of the locomotive exhaust stack above the ground. In SCREEN3 the “wind” speed was taken to be the locomotive velocity (5 mph in this study). As with the Roseville study, separate runs were made for the daytime and evening hours to account for differing atmospheric stabilities (State of California 2004b). Stability class D was assumed for the daytime hours (6 A.M. to 6 P.M.) and stability class F was assumed for the nighttime hours (6 P.M. to 6 A.M.). Dimensions of the various locomotives were estimated from scale drawings (Trainix 2001). The dimensions and other exhaust parameters that were obtained from various sources are shown in Table 22.

**TABLE 22
SCREEN3 EXHAUST PARAMETERS
[Throttle Notch 2]**

Engine	Stack Height (ft)	Engine Height (ft)	Engine Width (ft)	Engine Length (ft)	Speed (mph)	Stack Diameter ^a (inches)	Number of Stacks ^a	Stack Exit Velocity ^b (ft/s)	Exhaust Temperature ^b (°F)
SW1500	14.6	12.6	10	35	5	12.0	2	35.6	325
GP60M	15.1	14.4	10	53	5	24.6	1	32.8	348
ES44DC*	15.6	15.3	10	66	5	24.6	1	33.5	371
3GS21B	15.1	12.8	10	57	5	8.0	1**	45.5	550

Engine	Stack Height (m)	Engine Height (m)	Engine Width (m)	Engine Length (m)	Speed (m/s)	Stack Diameter ^a (m)	Number of Stacks ^a	Stack Exit Velocity ^b (m/s)	Exhaust Temperature ^b (°K)
SW1500	4.45	3.84	3.05	10.67	2.24	0.3048	2	10.84	435.93
GP60M	4.60	4.39	3.05	16.15	2.24	0.6253	1	9.99	448.71
ES44DC*	4.75	4.66	3.05	20.12	2.24	0.6253	1	10.22	461.48
3GS21B	4.60	3.90	3.05	17.37	2.24	0.2032	1**	13.85	560.93

Source:

^aFor SW1500, GP60M, and ES44DC—State of California 2004b Tables B-2, B-6, and B-7. For 3GS21B—Flurry, per. com. 2011

^bFor SW1500, GP60M, and ES44DC—State of California 2004b Tables B-2, B-6, and B-7. For 3GS21B— estimated from data provided by Flurry, per. com. 2011, and Short, per. com. 2011.

*ES44DC exhaust parameters were not available. SD70 parameters from the Roseville study were used as a surrogate for the ES44DC (State of California 2004b Table B-7).

11 NOTE: on April 11, 2011 the EPA replaced SCREEN3 with AERSCREEN as the recommended screening model (U.S. EPA 2011d). However, the AERSCREEN model does not output the plume rise accounting for downwash (EPA 2011e). Therefore, SCREEN3 was used in this assessment to calculate the exhaust plume rise of the moving locomotives while accounting for the “building” downwash due to the locomotive itself.

**The 3GS21B actually has three separate engines, each with its own exhaust stack, that run in combination depending on the locomotive notch setting. In Notch 2 only a single engine is running.

SCREEN3 input and output are contained in Attachment 12. Figure 40 illustrates the general plume geometry used in dispersion modeling. The vertical thickness of the plume was determined using the “rule-of-thumb” that the vertical plume thickness is approximately equal to the plume rise (Turner et al. 2007). For AERMOD the initial vertical dimension (σ_z) was taken to be the plume thickness divided by 4.3 and the initial lateral dimension (σ_y) was taken to be the length of the side of the volume source divided by 2.15 per Table 3-1 of the AERMOD user’s manual (2004b). Table 23 shows the resulting volume source geometrical inputs.

**TABLE 23
EXHAUST PLUME RISE AND AERMOD VOLUME SOURCE PARAMETERS**

Engine	Stability Class D (0600 to 1800)			Stability Class F (1800 to 0600.)			Initial Lateral Dimension (σ_y)	
	Plume Height (m)	Plume Rise (m)	(σ_z) (m)	Plume Height (m)	Plume Rise (m)	(σ_z) (m)	10 ft (3.05 m) Source	24 ft (7.32 m) Source
SW1500	9.14	4.69	1.09	18.46	14.01	3.26	1.42 m	3.40 m
GP60M	24.06	19.46	4.53	29.14	24.54	5.71		
ES44DC	25.24	20.49	4.76	29.54	24.79	5.76		
3GS21B	8.24	3.64	0.85	17.25	12.65	2.94		

For each train operation, separate volume sources were developed for the daytime and evening hours, as applicable, using the parameters shown in Table 23. The emissions from each volume source were then varied by hour of day as applicable to simulate the operations indicated in Table 21.

7.4.2.4 Receivers

Pollutant concentrations were modeled at a series of grid receivers throughout the Barrio Logan community. As seen in Figure 41, the receiver grid has 100-meter spacing and extends approximately ¼-mile beyond the proposed CPU boundary. For this assessment, flat site topography was assumed. Thus the non-default “FLAT” option was specified in AERMOD. Receivers were assumed to be “flagpole” receivers with a height of 5 feet.

7.4.3 Results

To reduce runs times, separate AERMOD runs were made for the BNSF vehicle, BNSF “local,” and SDIY train operations. The results of each set of runs were added together to get the resulting total average annual diesel particulate matter concentrations at each modeled receiver. The resulting total average annual diesel particulate matter concentrations were then used to calculate the incremental cancer risk and chronic health

hazard index at each receiver as described above. Attachment 13 contains the AERMOD input and output file for the BNSF vehicle trains. Attachment 14 contains the AERMOD input and output files for the BNSF “local” trains. Attachment 15 contains the AERMOD input and output files for the SDIY trains.

7.4.3.1 Carcinogenic Risk

As discussed previously, in general for health risk assessments it is recommended that the residential incremental cancer risk be reported for the average (65th percentile), 80th percentile, and high end (95th percentile) breathing rates. The results of this assessment indicate that the worst-case high end (95th percentile) residential incremental cancer risk due to diesel particulate matter emissions associated with main line rail operations in and adjacent to the Barrio Logan community is 10.1 in one million. The location of this maximum impact is shown in Figure 41 and occurs at the northwest end of the plan area near the BNSF rail yard. This high end residential incremental cancer risk is slightly greater than the significance threshold of 10 in one million. The 65th percentile, 80th percentile, and worker incremental cancer risks at this location are less than this value. At this point of maximum impact the average (65th percentile) residential incremental cancer risk is 7.0 in one million, the 80th percentile residential incremental cancer risk is 7.8 in one million, and the worker incremental cancer risk is 1.5 in one million. This location is immediately adjacent to Harbor Drive near industrial uses and, as such, the worker incremental cancer risk would apply to this location. Thus this impact would not be considered significant.

Figure 42 shows the 80th percentile breathing rate residential incremental cancer risk isopleths overlain on the adopted land use plan. Figure 43 shows the 80th percentile breathing rate residential incremental cancer risk isopleths overlain on the proposed CPU Alternative 1 land use plan. Figure 44 shows the 80th percentile breathing rate residential incremental cancer risk isopleths overlain on the proposed CPU Revised Alternative 2 land use plan. As seen from Figures 42 through 44, and as indicated above, the 80th percentile incremental cancer risk due to main line rail operations is less than 10 in one million throughout the plan area. The average residential incremental cancer risk would be 10.3 percent less than that shown in Figures 42, 43, and 44; the high-end residential incremental cancer risk would be 30.1 percent greater than that shown in Figures 42, 43, and 44; and the worker incremental cancer risk would be 80.3 percent less than that shown in Figures 42, 43, and 44.

Figure 42 also shows the locations of the modeled MEIR and MEIW for the adopted plan land uses. At the MEIR the average residential incremental cancer risk due to diesel particulates from the main line rail operations is 3.0 in one million; the 80th percentile residential incremental risk is 3.4 in one million; and the high-end residential incremental risk is 4.4 in one million. At the MEIW the worker incremental cancer risk due to diesel particulates from the main line rail operations is 1.1 in one million.

Figure 43 also shows the locations of the modeled MEIR and MEIW for the proposed CPU Alternative 1 land uses. At the MEIR the average residential incremental cancer risk due to diesel particulates from the main line rail operations is 3.8 in one million; the 80th percentile residential incremental risk is 4.2 in one million; and the high-end residential incremental risk is 5.5 in one million. At the MEIW the worker incremental cancer risk due to diesel particulates from the main line rail operations is 1.2 in one million.

Figure 44 also shows the locations of the modeled MEIR and MEIW for the CPU Revised Alternative 2 land uses. As with the proposed CPU Alternative 1 land uses, at the MEIR the average residential incremental cancer risk due to diesel particulates from the main line rail operations is 3.8 in one million; the 80th percentile residential incremental risk is 4.2 in one million; and the high-end residential incremental risk is 5.5 in one million. At the MEIW the worker incremental cancer risk due to diesel particulates from the main line rail operations is 1.2 in one million as is the case for the proposed CPU Alternative 1 land uses.

Therefore, incremental cancer risks to sensitive receivers due to the main line rail operations alone are not anticipated to be significant.

The incremental cancer risk due to the main line rail operations would, however, add to the other source risks discussed above in Section 4.5.2.4. A comparison of Figures 16 through 18 (as well as Figure 22 through 24) with Figures 42 through 44 illustrates that the bulk of incremental cancer risk in the Barrio Logan Community results from the adjacent rail yard activities and other sources and not from the main rail line operations through the community. This is discussed further in Section 7.5 below.

7.4.3.2 Chronic Risk

The results of the rail line analysis indicate that the maximum chronic hazard index at any of the modeled receivers is 0.005, well below the significance threshold of 1.0. The location of this maximum impact occurs at the same location as the maximum incremental cancer risk discussed above. Chronic risks resulting from diesel particulate matter emissions associated with the main rail line operations through and adjacent to the Barrio Logan community are not projected to be significant.

7.5 Total Assessed Health Risk

Based on the results of the analyses discussed above and on the results from the prior studies discussed in Section 4.5, estimation was made of the total incremental cancer risk impact by combining the incremental impacts of all of the individual sources discussed above. As discussed in Section 4.5.2.4, there is inherent uncertainty associated with combining all of the various results. Some of these uncertainties include:

1. “Offsite” sources in the BNSF rail yard study were limited to those sources within one mile of the rail yard. Thus other sources of air pollutants may exist that were not accounted for in this current study. Further,
 - a. There is overlap between the freeway/roadway analyses in the prior BNSF rail yard study and the current study. The specifics of this overlap are not known and must be inferred from the results.
 - b. The prior BNSF rail yard study only considered three primary stationary sources outside of the rail yard (National Steel and Shipbuilding, Southwest Marine, Inc., and Continental Maritime of San Diego, Inc.). There likely are other port operations south of these facilities for which emissions occur that could affect the Barrio Logan community.
2. There are likely differences in the assumptions regarding the emissions from the freeway and roadways between the current study and the prior BNSF rail yard study.
3. There are inherent problems in the contours developed in Section 4.5.2.4 and depicted in Figures 16 through 18 as discussed in that section.

With these understandings, the results of all of the foregoing analyses were used to estimate total incremental cancer risk contours due to all of the sources considered. These contours may not be conservative or all encompassing, but provide insight into the general conditions in the Barrio Logan area.

It is apparent that the prior rail yard studies discussed incremental cancer risk impacts in terms of the 80th percentile residential breathing rate. Therefore, for consistency between all results, the contours developed here are those corresponding to the 80th percentile residential breathing rate. Figure 45 shows the total incremental cancer risk isopleths overlain on the proposed CPU Alternative 1 land uses. Figure 46 shows the total incremental cancer risk isopleths overlain on the proposed CPU Revised Alternative 2 land uses. Specific truck route truck volumes were not provided for the adopted plan land uses, thus specific truck route impacts were not developed for the adopted plan land uses. Comparison of the various parameters available for the adopted plan with those for the proposed CPU alternatives indicate that the total incremental cancer risk isopleths for the adopted plan would be similar to those projected for the proposed CPU alternatives. Therefore, the proposed CPU Alternative 1 land use total incremental cancer risk isopleths are shown in Figure 47 overlain on the adopted plan land uses for comparison to the other plan alternatives.

As seen in these figures, much of the Barrio Logan community is exposed to incremental cancer risks in excess of 150 in one million and may approach 300 in one million in limited areas. Furthermore, although the contours in Figures 45 through 47 imply reduced risks in

the southern portions of the planning area, as mentioned there may be sources of air pollutant emissions in the southerly areas that are not addressed in this study.

The incremental cancer risks shown in Figures 45 through 47 are in addition to the overall background risk. As discussed in Section 4.5.2.4, the background cancer risk due to air toxics could be approximately 555 to 570 in one million. Thus the total cancer risk in limited portions of the Barrio Logan community could be as high as almost 900 in one million. This total risk is due to sources outside of the Barrio Logan community.

The incremental and total cancer risks to the land uses for the adopted and proposed CPU land use alternatives would be similar and are considered significant for all plan alternatives.

The total chronic health hazard indices from all combined evaluated sources are anticipated to be less than 1 throughout the community. Therefore, total chronic risk is anticipated to be less than significant.

8.0 Conformance with Regional Plans and City Criteria

8.1 California Air Resources Board

1. Is an Air Quality Plan being implemented in the area where the project is proposed?

The proposed CPU area is in the city of San Diego, which is within the SDAB. The 1991/1992 RAQS/TCMs (and triennial updates) and applicable portions of the SIP are implemented by the APCD throughout the air basin. Therefore, the proposed project fulfills the first criteria from the CARB guidelines described in the Thresholds of Significance section (Section 5.1).

2. Is the proposal consistent with the growth assumptions of the applicable AQMP?

As noted above, the RAQS, TCMs, and SIP developed by the APCD and/or SANDAG set forth the steps needed to accomplish attainment of State and federal ambient air quality standards. The basis for these plans is the distribution of population in the region as projected by SANDAG. Amending the Barrio Logan Community Plan to change development potential would, necessarily, result in an inconsistency between the current air quality plans (that are based on the existing community plan) and the amended community plan.

Relative to the adopted community plan, proposed CPU Alternative 1 would:

- increase the number of residential units by approximately 32.6 percent;
- increase the amount of land designated for commercial development by 25.8 percent; and
- decrease the amount of land designated for industrial use by 49.9 percent.

Relative to the adopted community plan, proposed CPU Revised Alternative 2 would:

- increase the number of residential units by approximately 14.8 percent;
- increase the amount of land designated for commercial development by 41.6 percent; and
- decrease the amount of land designated for industrial use by 44.5 percent.

Additionally, the proposed CPU alternatives would require a change in zoning. Therefore, the proposed land use changes proposed under either proposed CPU alternative would not be consistent with the adopted General Plan upon which the RAQS and SIP were based and thus would not be consistent with the growth assumptions used in development of the local air quality plans.

Development under the existing the adopted community plan would generate approximately 180,666 vehicles per day. Development associated with the proposed CPU Alternative 1 land uses would result in approximately 137,267 ADT, which is 43,399 fewer trips than what would occur under the adopted community plan. Development associated with the proposed CPU Revised Alternative 2 land uses would result in approximately 140,140 ADT, which is 40,526 fewer trips than what would occur under the adopted community plan (Kimley–Horn and Associates, Inc. 2011; Addendum 2012).

Although the number of daily trips are anticipated to decrease for either of the proposed CPU alternatives relative to the adopted community plan, as discussed in Section 6.3.6 the relative change in criteria pollutant emissions may increase or decrease depending on the criteria pollutant under consideration. As seen in Table 11, combined emissions of ozone precursors would be greater under proposed CPU Alternative 1 than would occur under the adopted community plan; however, the combined emissions of ozone precursors would be less under proposed CPU Revised Alternative 2 than would occur under the adopted community plan. The SDAB is a federal and State non-attainment area for ozone. Both proposed CPU Alternatives 1 and 2 would result in greater $PM_{2.5}$ emissions than would occur under the adopted community plan. The SDAB is a State non-attainment area for $PM_{2.5}$. Emissions of SO_2 and PM_{10} under the proposed CPU alternatives would be less than those expected under the adopted community plan. Emissions of CO would be less than the

adopted community plan under proposed CPU Revised Alternative 2 and proposed CPU Alternative 1 than under the adopted community plan.

As such it is concluded that either of the proposed CPU alternatives would conflict with the adopted air plans and result in increases in criteria air pollutant emissions for which the basin is non-attainment. This is considered a significant impact. It is noted that non-attainment criteria pollutant emissions under proposed CPU Revised Alternative 2 are less than those that would occur under proposed CPU Alternative 1, specifically for the ozone precursors and PM_{2.5}.

3. Does the project contain in its design all reasonably available and feasible air quality control measures?

With the exception of projects developed by right, approval of the proposed CPU would not permit the construction of any other individual projects, and no specific development details are available at this time. The individual projects subject to subsequent review would be required to use best management practices to decrease emissions.

8.2 City of San Diego

1. Could implementation of the proposed CPU result in an increased number of automobile trips or stationary source emissions which could potentially affect San Diego's ability to meet regional, state and federal clean air standards, including the (RAQS) [sic] or SIP?

Although the proposed CPU alternatives would result in fewer overall trips than are anticipated to occur under the adopted community plan, as discussed above the proposed CPU Alternative 1 is generally anticipated to result in greater emissions of criteria pollutants for which the air basin is non-attainment than would occur under the adopted community plan. Also, the proposed CPU Revised Alternative 2 is anticipated to result in greater emissions of one criteria pollutant (PM_{2.5}) for which the air basin is non-attainment than would occur under the adopted community plan. This would conflict with the current SIP and RAQS/TCMs and represents a potentially significant impact. As noted, however, with the exception of PM_{2.5}, emissions of all other criteria pollutants would be less under Revised Alternative 2 than under the adopted community plan.

2. Could implementation of the proposed CPU result in air emissions that could substantially deteriorate ambient air quality, including the exposure of sensitive receptors to substantial pollutant concentrations?

The region is classified as non-attainment for ozone, PM₁₀, and PM_{2.5}. The SDAB is non-attainment for the eight-hour federal and State ozone standards, and non-attainment for the State PM₁₀ and PM_{2.5} standards. Ozone is not emitted directly, but is a result of atmospheric activity on precursors. Nitrogen oxides and hydrocarbons (reactive organic gases) are

known as the chief “precursors” of ozone. These compounds react in the presence of sunlight to produce ozone.

As discussed above, emissions due to construction of small individual projects are not expected to exceed the applicable thresholds. Approval of the proposed CPU would not permit the construction of any individual project, and no specific development details are available at this time. The information related to construction is presented in Section 6.2 to illustrate the potential scope of air impacts for future projects that could be reviewed under the proposed community plan. However, it is not anticipated that construction impacts would be significant.

Long-term emissions of air pollutants occur from area and mobile sources. Area source pollutant emissions include those generated by the consumption of natural gas and electricity for space and water heating and the burning of wood in residential fireplaces. Vehicle travel would generate mobile source emissions including carbon monoxide, nitrogen oxides, and hydrocarbons

As discussed in Section 6.3.6 and seen in Table 11, with the exception of SO₂, PM₁₀, and CO, future criteria pollutant emissions would be greater under proposed CPU Alternative 1 than are anticipated under the adopted community plan. Regarding proposed CPU Revised Alternative 2, future emissions of PM_{2.5} would be greater than the adopted community plan. These are considered significant impacts. The proposed CPU Revised Alternative 2 would result in somewhat lower criteria pollutant emissions than those projected to occur under the proposed CPU Alternative 1. Given the modeling results, both alternatives represent a significant adverse impact when compared to existing conditions, as does the adopted community plan.

The incremental cancer risks due to diesel particulate emissions from freeway traffic are discussed in Section 7.2. It was determined that the incremental cancer risk impacts due to diesel particulates emanating from freeway traffic would exceed 10 in one million throughout much of the community. Although there is no adopted standard for evaluating the impacts due to emissions from mobile sources, such as vehicles traveling the freeways, as discussed in Section 5.5 the commonly used incremental cancer risk threshold of 10 in one million was used as the threshold of significance in this assessment. Based on this threshold, these effects are considered to constitute a significant impact.

The incremental cancer risks due to diesel particulate emissions from truck traffic on the designated truck routes are discussed in Section 7.3. Although more limited in extent than impacts from the freeways, it was determined that the incremental cancer risk impacts due to diesel particulates emanating from the truck traffic would exceed 10 in one million at certain locations within the community. Again, although there is no adopted standard for evaluating the impacts due to emissions from mobile sources, such as trucks traveling the truck routes through the community, as with the freeway impacts these effects are considered to constitute a significant impact.

The analysis of diesel particulate emissions from main rail line operations described in Section 7.4 above demonstrates that diesel particulate risks from the main rail line operations through the community are not individually anticipated to be significant.

The combined cancer risk from all sources evaluated in this study, when combined with overall background risks in the SDAB, could approach 900 in one million at certain locations within the community and generally exceeds 10 in one million throughout the community. Although many of the sources are mobile in nature and thus do not have specific standards for evaluating impacts, this is considered to constitute a significant impact to sensitive receivers within the community. Since most of the sources are not associated with the proposed CPU, no mitigation is available.

The analyses indicate that total chronic health risks from the evaluated sources are not anticipated to be significant.

In regards to the significant cancer health risk discussed above, it is also noted that numerous residential uses in the adopted and proposed CPU land use plans are located within 500 feet of the area freeways. As mentioned, guidance in the CARB's Air Quality and Land Use Handbook recommends that siting new sensitive land uses within 500 feet of a freeway be avoided when possible.

Finally, with respect to odors, although the proposed CPU area is adjacent to numerous industrial operations, there are no known sources of specific, long-term odors in the area. There are no agricultural operations in the proposed CPU area. The proposed CPU would allow a variety of land uses that are not typically associated with the creation of objectionable odors. The proposed CPU does not propose any specific new sources of odor that could affect sensitive receptors. Impacts associated with odors are anticipated to be less than significant.

9.0 Conclusions and Recommendations

- The proposed CPU land use changes would be inconsistent with the adopted air quality plans upon which the current RAQS and SIP were based. In addition certain criteria pollutant emissions of concern under the proposed CPU alternatives are greater than those anticipated to occur under the adopted community plan. Specifically, the ozone precursors and $PM_{2.5}$ are higher for the proposed CPU Alternative 1 than the adopted community plan, and $PM_{2.5}$ is higher for the proposed CPU Revised Alternative 2 than the adopted community plan. Therefore, the proposed CPU alternatives would not conform to the current air quality plans. Consequently, adoption of either of the proposed CPU alternatives would result in a significant conflict with the adopted air plans. Because the significant air impact stems from an inconsistency between the proposed CPU and the adopted land use

plans upon which the RAQS and SIP were based, the only measure that can lessen this effect is the revision of the RAQS and SIP based on the proposed CPU. This effort is the responsibility of SANDAG and the APCD and is outside the jurisdiction of the City. As such, no mitigation is available to the City. Impacts remain significant.

- Future criteria pollutant emissions under proposed CPU Alternative 1, with the exception of SO₂, PM₁₀, and CO, are projected to be greater than future criteria pollutant emissions anticipated under the adopted community plan. Future PM_{2.5} emissions under proposed CPU Revised Alternative 2 are projected to be greater than future emissions of these pollutants anticipated under the adopted community plan. However, future combined ozone precursors (ROG, NO_x), CO, SO₂, and PM₁₀ emissions under proposed CPU Revised Alternative 2 are projected to be less than future emissions of these pollutants anticipated under the adopted community plan.

Except for NO_x, future emissions of all criteria pollutants under the adopted plan and both proposed CPU alternatives are anticipated to be greater than existing criteria pollutant emissions. Future emissions of NO_x under the adopted community plan, the proposed CPU Alternative 1 and the proposed CPU Revised Alternative 2 are anticipated to be less than existing emissions. The reduction in future NO_x emissions relative to existing emissions for the adopted community plan and the proposed alternatives is due to decreased mobile source emissions resulting from vehicle emission improvements.

As discussed above, an increase in future emissions of particulates and ozone precursors would result in a significant air quality impact. No mitigation is available for this impact. Impacts remain significant. Proposed CPU Revised Alternative 2 would result in somewhat lower criteria pollutant emissions than would occur under proposed CPU Alternative 1.

- In addition, the incremental and total cancer risks due to exposure to diesel particulate matter and other toxic emissions in the area are considered significant. The only means of reducing these effects is the implementation of source controls. The CARB has worked on developing strategies and regulations aimed at reducing the risk from diesel particulate matter. Further, the APCD is charged with regulating air toxic emissions in the SDAB. Impacts remain significant and inmitigable. The absolute incremental and total cancer risks for the adopted community plan and for proposed CPU Alternatives 1 and 2 are similar. Because proposed CPU Revised Alternative 2 proposes less residential development than proposed CPU Alternative 1, relative cancer risks associated with proposed CPU Revised Alternative 2 would generally be considered less than those associated with proposed CPU Alternative 1 since a smaller residential population would be exposed to the risk.

Further, because the adopted community plan designates fewer residential units than either proposed CPU alternative, relative incremental and total cancer risk

impacts associated with the adopted community plan while still significant are considered less than those under the proposed CPU alternatives, again due to the smaller exposed residential population.

- The proposed CPU does not propose any specific new sources of odor that could affect sensitive receptors. Impacts associated with odors are anticipated to be less than significant.

10.0 References Cited

California, State of

- 1989a Guidelines for Air Quality Impact Assessment for General Development and Transportation-Related Projects. June.
- 1989b CALINE4 – A Dispersion Model for Predicting Air Pollutant Concentrations Near Roadways. Report number FHWA/CA/TL-84-15. Department of Transportation (Caltrans), Division of New Technology and Research. June.
- 2000 Risk Reduction Plan to Reduce Particulate Matter Emissions from Diesel-fueled Engines and Vehicles. California Air Resources Board. Stationary Source Division, Mobile Source Control Division. October.
- 2002 *Air Quality at Memorial Academy Charter School in Barrio Logan, a Neighborhood Community in San Diego*. California Air Resources Board. June. Available online at <http://www.arb.ca.gov/ch/communities/studies/barriologan/barriologan.htm>.
- 2003a *Ambient Air Monitoring for Hexavalent Chromium and Metals in Barrio Logan: May 2001 through May 2002*. Prepared by Kathy Gill, Operations Planning and Assessment Section. Approved by the Monitoring and Laboratory Division Quality Management Branch Monitoring and Laboratory Division. California Air Resources Board October 14. Available online at <http://www.arb.ca.gov/ch/communities/studies/barriologan/barriologan.htm>.
- 2003b The Air Toxics Hot Spots Program Guidance Manual for Preparation of Health Risk Assessments. Office of Environmental Health Hazard Assessment, California Environmental Protection Agency. August.
- 2003c Air Resources Board Recommended Interim Risk Management Policy for Inhalation-Based Residential Cancer Risk. California Air Resources Board. October 9.
- 2004a *Barrio Logan Report: A Compilation of Air Quality Studies in Barrio Logan*. November. California Air Resources Board. November. Available online at <http://www.arb.ca.gov/ch/communities/studies/barriologan/barriologan.htm>.
- 2004b *Roseville Rail Yard Study*. Stationary Source Division, Air Resources Board. October 14. Available online at <http://www.arb.ca.gov/railyard/hra/hra.htm>.
- 2005 *Air Quality and Land Use Handbook: A Community Health Perspective*. California Air Resources Board. April.

- 2006a *ARB Health Risk Assessment Guidance for Rail Yard and Intermodal Facilities*. Air Resources Board. September. Available online at <http://www.arb.ca.gov/railyard/hra/hra.htm>.
- 2006b EMFAC2007/Version 2.30 – Calculating Emission Inventories for Vehicles in California. User's Guide. November.
- 2008a *Health Risk Assessment for the BNSF Railway San Diego Railyard*. Stationary Source Division, Air Resources Board. June 9. Available online at <http://www.arb.ca.gov/railyard/hra/hra.htm>.
- 2008b *ARB Recommended Interim Risk Management Policy for Inhalation-Based Residential Cancer Risk – Frequently Asked Questions*. California Air Resources Board. July 29. Obtained from the CARB website at <http://www.arb.ca.gov/toxics/harp/rmpolicyfaq.htm> on May 31, 2011.
- 2009 The California Almanac of Emissions and Air Quality—2009 Edition. Planning and Technical Support Division. California Air Resources Board.
- 2010a Ambient Air Quality Standards. California Air Resources Board. September 8.
- 2010b ARB Programs. Pages obtained from the CARB website at <http://www.arb.ca.gov/html/programs.htm> on December 23.
- 2010c *PM_{2.5} and PM₁₀ Natural Event Document – Southern California High Winds and Wildfires October/November 2007*. Obtained from the CARB website at <http://www.arb.ca.gov/desig/excevents/2007wildfires.htm> on January 3, 2011. (indicated to be a draft document on the website).
- 2010d Consolidated Table of OEHHA/ARB Approved Risk Assessment Health Values. October 18. Obtained from the CARB website at <http://www.arb.ca.gov/toxics/healthval/healthval.htm> on November 4, 2010.
- 2011a iADAM Air Quality Data Statistics. Obtained from the CARB website at <http://www.arb.ca.gov/adam/welcome.html> on May 24, 2011.
- 2011b ARB's Drayage Truck Regulatory Activities. Obtained from the CARB website at <http://www.arb.ca.gov/msprog/onroad/porttruck/porttruck.htm> on May 27, 2011.
- 2011c California Emissions Estimator model (CalEEMod). User's Guide Version 2011.1. Prepared for the South Coast Air Quality Management district by ENVIRON International Corporation. February.

Domen, Matt (San Diego and Imperial Valley Railroad)

2011a E-mail to Karyl Palmer, RECON, re: Reply to a request for Information. March 17, 8:44 A.M.

2011b E-mail to Karyl Palmer, RECON, re: Reply to a request for Information. April 13, 11:51 A.M.

2011c E-mail to Karyl Palmer, RECON, re: Reply to a request for Information. April 25, 3:01 P.M.

2011d E-mail to David Gottfredson, RECON, re: Reply to a request for Information. May 10, 4:34 P.M.

Dudek

2009 Health Risk Assessment for the South Line Rail Goods Movement Project, San Diego County, California. November.

ENVIRON

2008a *San Diego TAC Emissions Inventory*. Prepared for the Burlington Northern and Santa Fe Railway Company. January 10. Available online at <http://www.arb.ca.gov/railyard/hra/hra.htm>.

2008b *Air Dispersion Modeling Assessment of Air Toxic Emissions from BNSF San Diego Rail Yard*. Prepared for BNSF Railway Company. February 4. Available online at <http://www.arb.ca.gov/railyard/hra/hra.htm>.

Environmental Health Coalition (EHC)

2011 Research Brief: 2010 Air Quality trends in Barrio Logan Based on PM_{2.5} and EC/OC data from Beardsley Monitor. February.

Espelet, Leo (Kimley-Horn and Associates, Inc.)

2010 E-mail to Donna Steel, RECON, re: Barrio Logan – traffic mobility study secure ftp site created. November 22, 9:32 A.M.

Flurry, Roberta (National Railway Equipment Company)

2011 E-mail to Karyl Palmer, RECON, re: Reply to a request for information regarding NRE 3GS21B. April 7, 7:20 A.M.

Hammer, Michael (Trinity Consultants, Inc./Breeze Software and Data Services)

2011 E-mail to David Gottfredson, RECON, re: AERMOD Model-Ready Meteorological Data. March 24, 12:37 P.M.

Air Quality and Health Risk Technical Analyses for the Barrio Logan Community Plan Update

Kimley-Horn and Associates, Inc.

2011 *Traffic Impact Analysis, Barrio Logan Community Plan Update*. March.

Kimley-Horn and Associates, Inc.

2012 *Addendum to Traffic Impact Analysis, Barrio Logan Community Plan Update*. July.

Lakes Environmental Software

2011 WRPLOT View software, Version 6.5.2. Obtained from the Lakes Environmental Software website at: <http://www.weblakes.com/download/freeware.html> on April 4, 2011.

Phillips, Edward P. (BNSF Railway)

2011a E-mail to Karyl Palmer, RECON, re: San Diego Trains. March 28, 7:58 A.M.

2011b E-mail to Karyl Palmer, RECON, re: San Diego Trains. April 13, 1:59 P.M.

2011c E-mail to Karyl Palmer, RECON, re: San Diego Trains. April 26, 7:34 A.M.

San Diego, City of

2010 *Scope of Work for a Program Environmental Impact Report (PEIR) for the Barrio Logan Community Plan Update*. Development Services Department. October 8.

2011 *Significance Determination Thresholds, California Environmental Quality Act*. Development Services Department. January.

San Diego, County of

1992 1991/1992 Regional Air Quality Strategies. Air Pollution Control District. June.

1998 Air Quality in San Diego County. 1997 Annual Report. San Diego Air Pollution Control District.

1999 Air Quality in San Diego County. 1998 Annual Report. San Diego Air Pollution Control District.

2006 *Supplemental Guidelines for Submission of Air Toxics "Hot Spots" Program Health Health [sic] Risk Assessments (HRAs)*. San Diego Air Pollution Control District. June.

2008 *Air Quality in San Diego County*. 2007 Annual Report. San Diego Air Pollution Control District.

2009 *Air Quality in San Diego County*. 2008 Annual Report. San Diego Air Pollution Control District.

2010a *Rules & Regulations*. Available online from the APCD website at <http://www.APCD.org/rules/rules.html>.

2010b *Air Quality in San Diego County*. 2009 Annual Report. San Diego Air Pollution Control District.

2010c *2009 Air Toxics "Hot Spots" Program Report for San Diego, County*. California Air Toxics "Hot Spots" Information and Assessment Act (AB 2588). San Diego Air Pollution Control District. December 8.

San Diego, Port of

2009 *Vessel Speed Reduction Fact Sheet*. Obtained from the Port of San Diego website at <http://www.portofsandiego.org/environment.html> on May 27, 2011.

2010 *Vessel Speed Reduction Program Quarterly Report*. Obtained from the Port of San Diego website at <http://www.portofsandiego.org/environment.html> on May 27, 2011.

2011 *Data Shows Shore Power System Reducing Tons of Air Pollutants*. Article dated May 10, 2011. Obtained from the Port of San Diego website at <http://www.portofsandiego.org/environment/2552-data-shows-shore-power-system-reducing-tons-of-air-pollutants.html> on May 27, 2011.

SanGIS

2003 *Census Block/Pop&Housing* GIS shapefile obtained from the SanGIS website at: http://www.sangis.org/Download_GIS_Data.htm on November 6, 2010.

SD Freight Rail Consulting

2005 *Draft Health Risk Assessment, San Diego & Imperial Valley Railroad, San Diego Yard, Impact to Ballpark Village Project*. August. Available online at <http://www.arb.ca.gov/railyard/hra/hra.htm>.

Short, Ron

2011 E-mail to Karyl Palmer, RECON, re: Request for information regarding NRE 3GS21B. VMV Paducahbilt, Inc. April 19, 12:40 P.M.

South Coast Air Quality Management District (SCAQMD)

2003 *Final 2003 Air Quality Management Plan*. August 1.

2006 *Final—Methodology to Calculate Particulate Matter (PM) 2.5 and PM 2.5 Significance Thresholds*. October.

Trainiax

2011 Scale Train Drawings, 1:36 scale. Obtained from the Trainiax web site at <http://trainiax.net/> on April 22 and May 13, 2011.

Turner, Bruce D., CCM, and Richard H. Schulze, P.E., QEP

2007 *Practical Guide to Atmospheric Dispersion Modeling*. Dallas: Trinity Consultants and Air & Waste Management Association.

U.S. Department of the Navy

2011 Naval Base San Diego—Environmental Protection Compliance. Obtained from the U.S. Navy website at <http://www.cnic.navy.mil/SanDiego/OperationsAndManagement/EnvironmentalSupport/EnvironmentalProtectionCompliance/index.htm> on May 27, 2011.

U.S. Environmental Protection Agency (EPA)

1995a *Industrial Source Complex (ISC3) Dispersion Model User's Guide – Volume I and II*. EPA-454/B-95-003a and b. September.

1995b *SCREEN3 Model User's Guide*. EPA-454/B-95-004. September.

1997 *Exposure Factors Handbook, Volume I, General Factors*. EPA/600/P-95/002Fa. August.

2004a Air Quality Designations and Classifications for the Fine Particles (PM_{2.5}) National Ambient Air Quality Standards; Final Rule. Federal Register 70(3):944-1019, January 5.

2004b *User's Guide for the AMS/EPA Regulatory Model – AERMOD*. EPA-454/B-03-001. September.

2004c *User's Guide for the AERMOD Meteorological Preprocessor (AERMET)*. EPA-454/B-03-002. November.

2009a Proposed Rule to Implement the 1997 8-Hour Ozone National Ambient Air Quality Standard: Revision on Subpart 1 Area Reclassification and Anti-Backsliding Provisions under Former 1-Hour Ozone Standard, Proposed Rule. Federal Register 74(11):2936-2945. January 16.

2009b Air Quality Designations for the 2006 24-Hour Fine Particle (PM_{2.5}) National Ambient Air Quality Standards: Final Rule. Federal Register 74(218): 58717. November 13.

2011a Air Data: Access to Air Pollution Data. Obtained from the EPA website at <http://www.epa.gov/air/data/index.html> on May 24.

2011b *User's Guide for the AMS/EPA Regulatory Model – AERMOD – Addendum* (EPA-454/B-03-001, September 2004). March.

2011c *User's Guide for the AERMOD Meteorological Preprocessor (AERMET) – Addendum* (EPA-454/B-03-002, November 2004). February.

2011d *AERSCREEN Released as the EPA Recommended Screening Model*. Memorandum to EPA Regional Modeling Contacts from Tyler Fox, Leader Air Quality Modeling Group, C439-01. April 11.

2011e *AERSCREEN User's Guide*. EPA-454/B-11-001. March.

University of California Riverside

2003 Measurement of Toxic Air Pollutants for Neighborhood Assessment: Final Report for Barrio Logan Measurement Study. Prepared by Dennis Fitz, Co-Principal Investigator, College of Engineering–Center for Environmental Research and Technology. Prepared for Todd Sax, California Air Resources Board, Planning and Technical Support Division, Contract No. 00-720. August 27. Available online at <http://www.arb.ca.gov/ch/communities/studies/barriologan/barriologan.htm>.

West Coast Collaborative

2011 *DERA Act Signed*. Obtained from the West Coast Collaborative website at <http://westcoastcollaborative.org/> on July 19, 2011.

Western Regional Climate Center (WRCC)

2011 Western U.S. Climate Historical Summaries. Obtained from the WRCC website at <http://www.wrcc.dri.edu/cgi-bin/cliMAIN.pl?ca7740> on May 24, 2011.

This page is intentionally blank.

ATTACHMENTS

This page is intentionally blank.

ATTACHMENT 1

This page is intentionally blank.



 Barrio Logan Community Plan Area

FIGURE 1
Regional Location of the Barrio Logan Community Plan Area

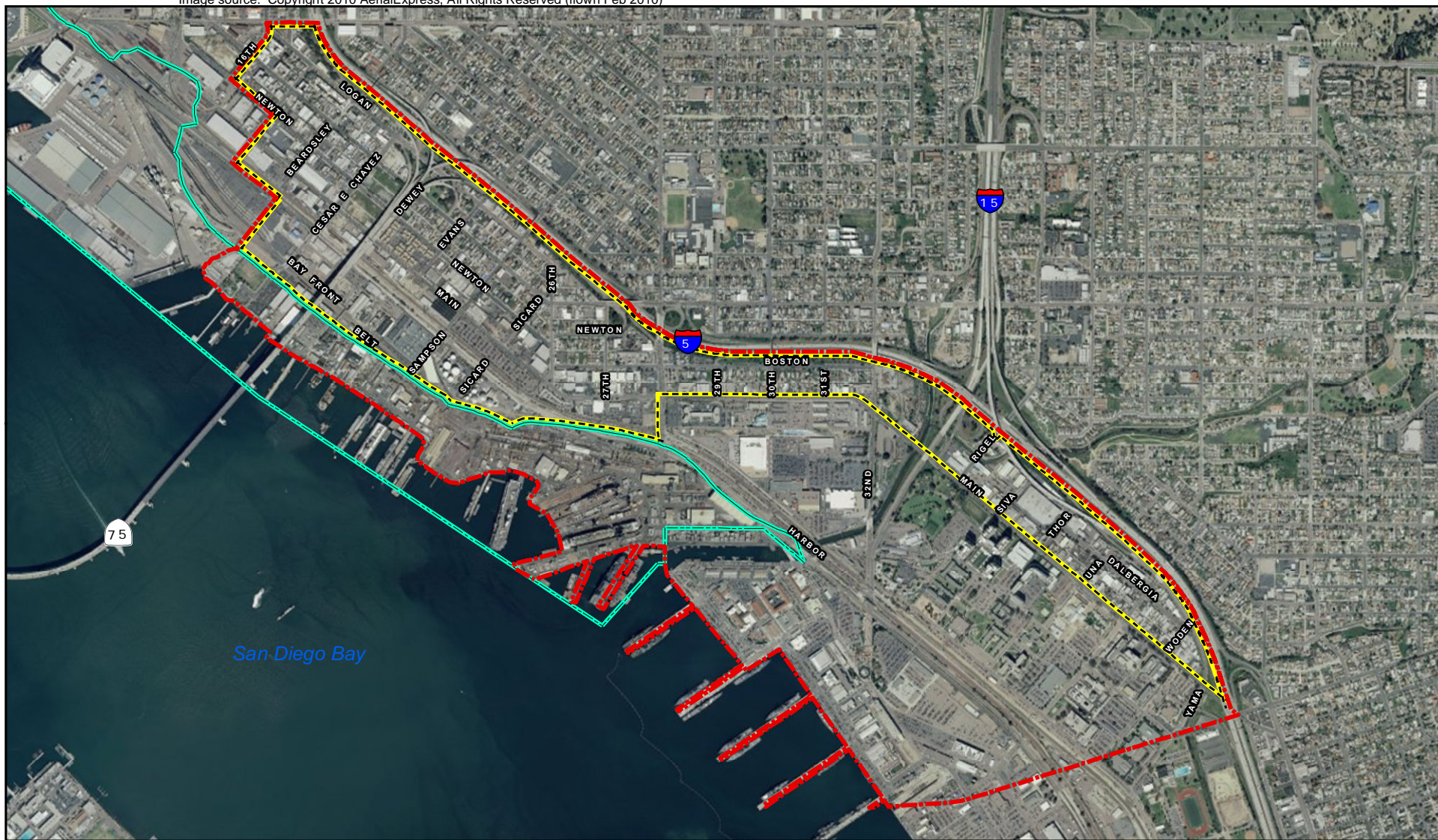

-  Project Area
-  City of San Diego Jurisdictional Lands
-  San Diego Unified Port District Limits

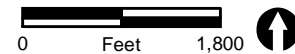
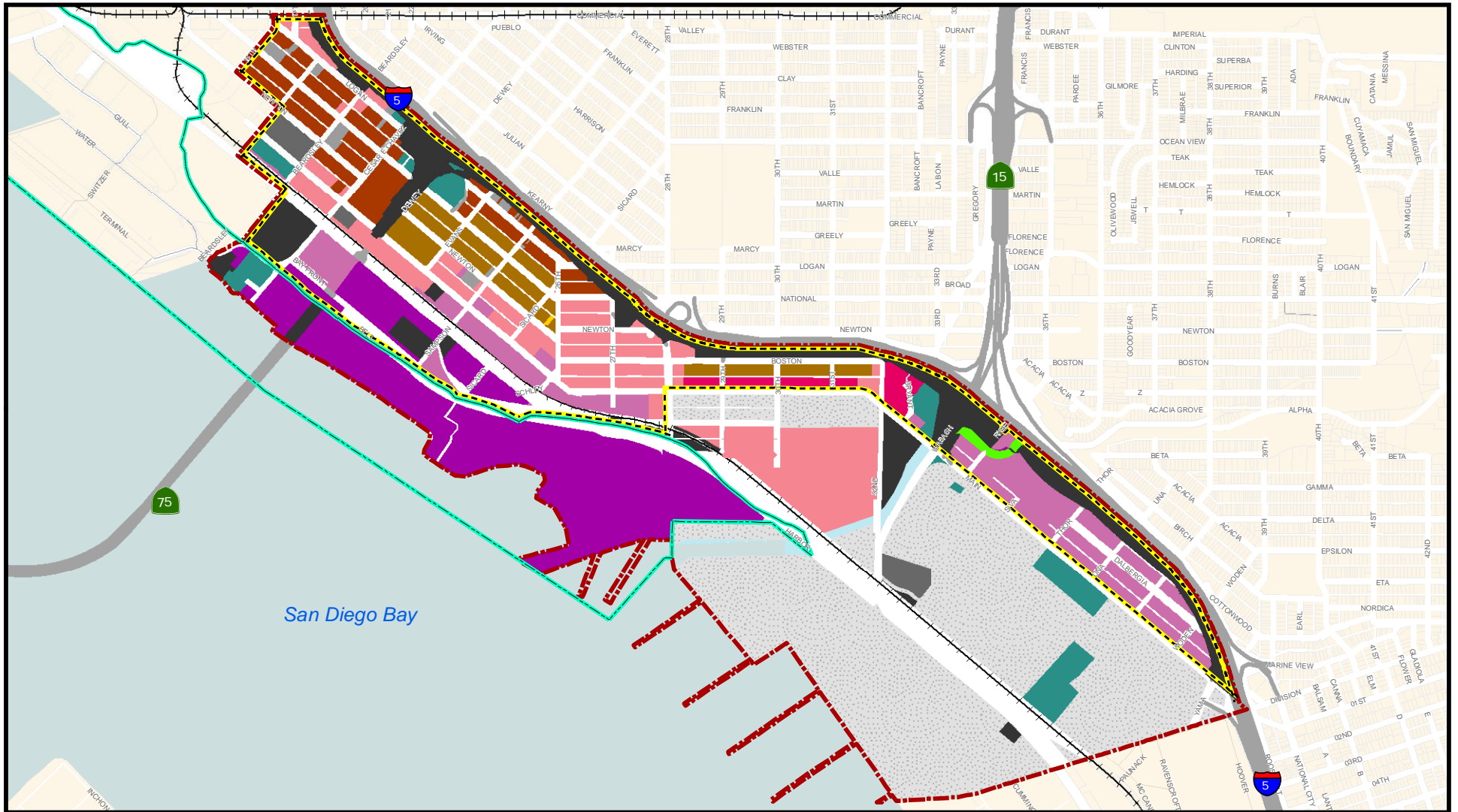

FIGURE 2
Barrio Logan Community Plan Area on Aerial Photograph



- | | | | |
|--|---------------------------|---|------------------|
| Barrio Logan Community Plan Area | Adopted Land Use | Heavy Industry | Recreation |
| City of San Diego Jurisdictional Lands | Single Family Residential | Light Industry | Open Space Parks |
| San Diego Unified Port District Limits | Multi-Family Residential | Transportation, Communications, Utilities | Water |
| Light Rail | Mixed Use | Education | |
| | Shopping Centers | Institutions | |
| | Commercial and Office | Military | |

0 Feet 1,500

FIGURE 3a
Adopted Community Plan Land Uses

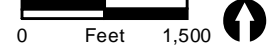
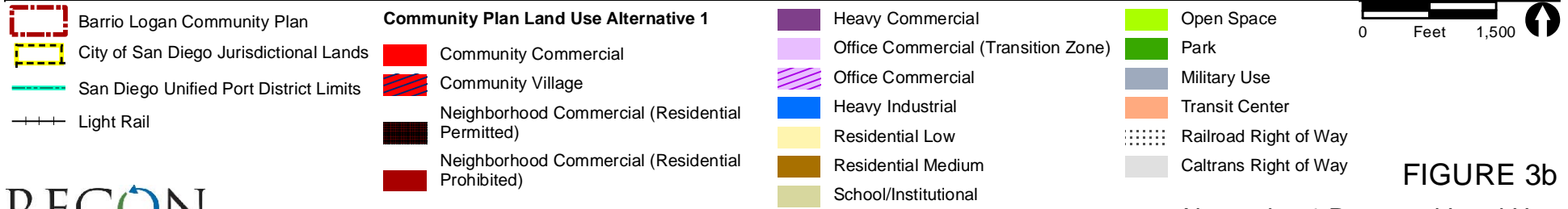
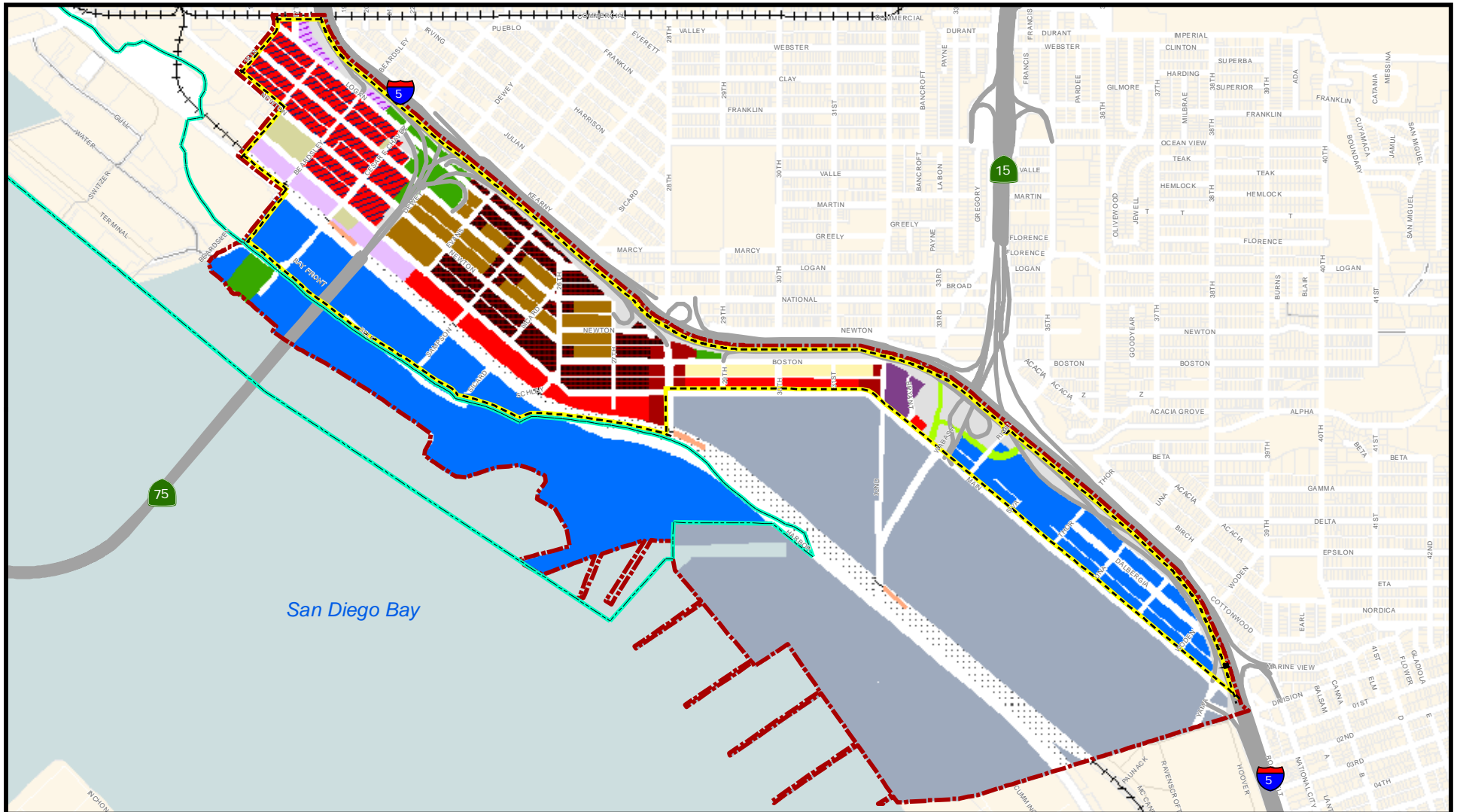
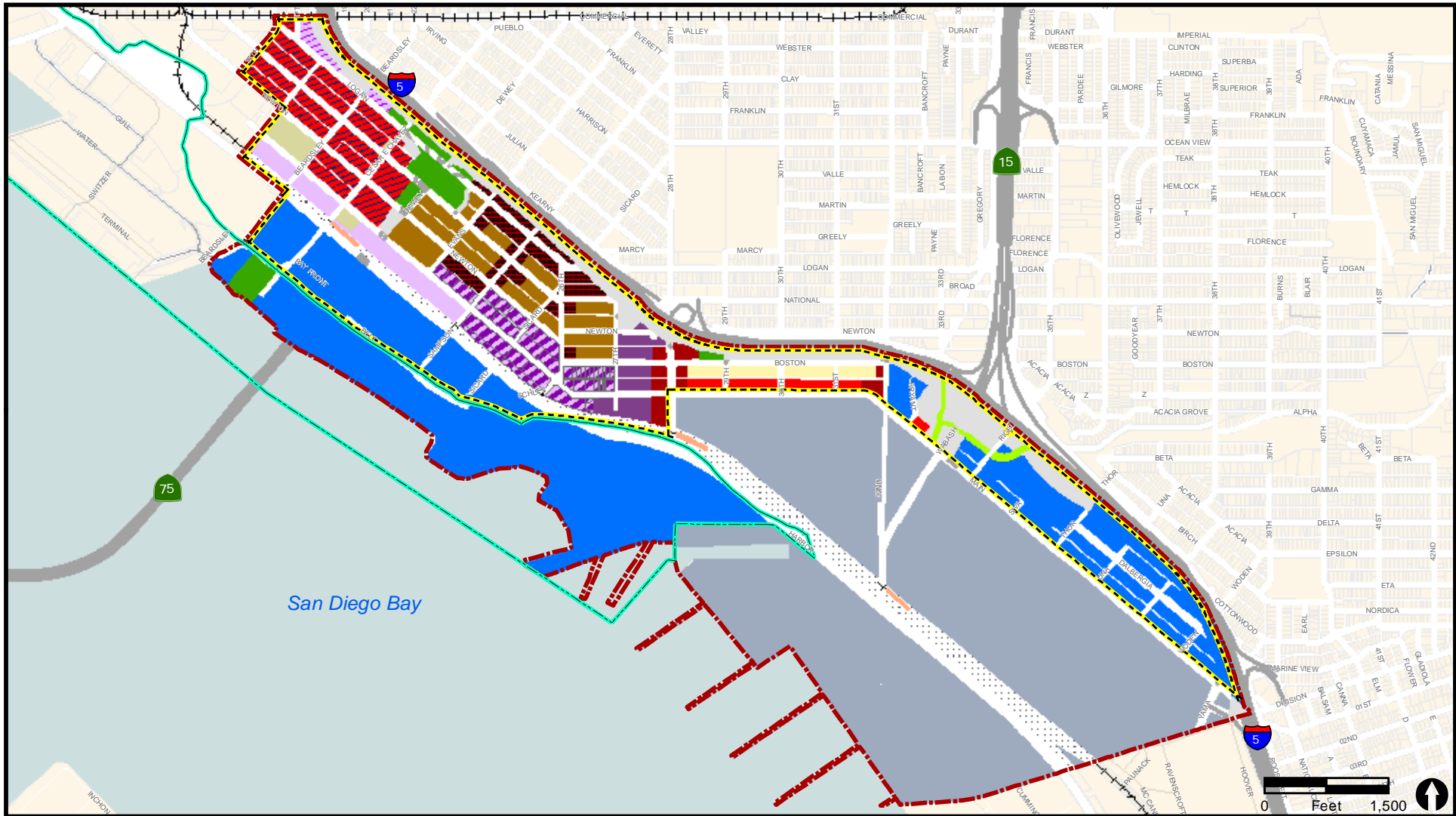

FIGURE 3b
Alternative 1 Proposed Land Use



- Barrio Logan Community Plan
- City of San Diego Jurisdictional Lands
- San Diego Unified Port District Limits
- Light Rail

Community Plan Land Use Alternative 2

- Community Commercial
- Community Village
- Neighborhood Commercial (Residential Permitted)

- Neighborhood Commercial (Residential Prohibited)
- Heavy Commercial
- Maritime Oriented Commercial
- Office Commercial (Transition Zone)
- Office Commercial

- Heavy Industrial
- Residential Low
- Residential Medium
- School/Institutional
- Open Space
- Park
- Military Use
- Transit Center
- Railroad Right of Way
- Caltrans Right of Way

RECON

M:\JOBS3\4716\common_gis\fig03c_AirTech.mxd 7/20/2012

FIGURE 3c
Revised Alternative 2 Proposed Land Use

Map Source: City of San Diego, 2011

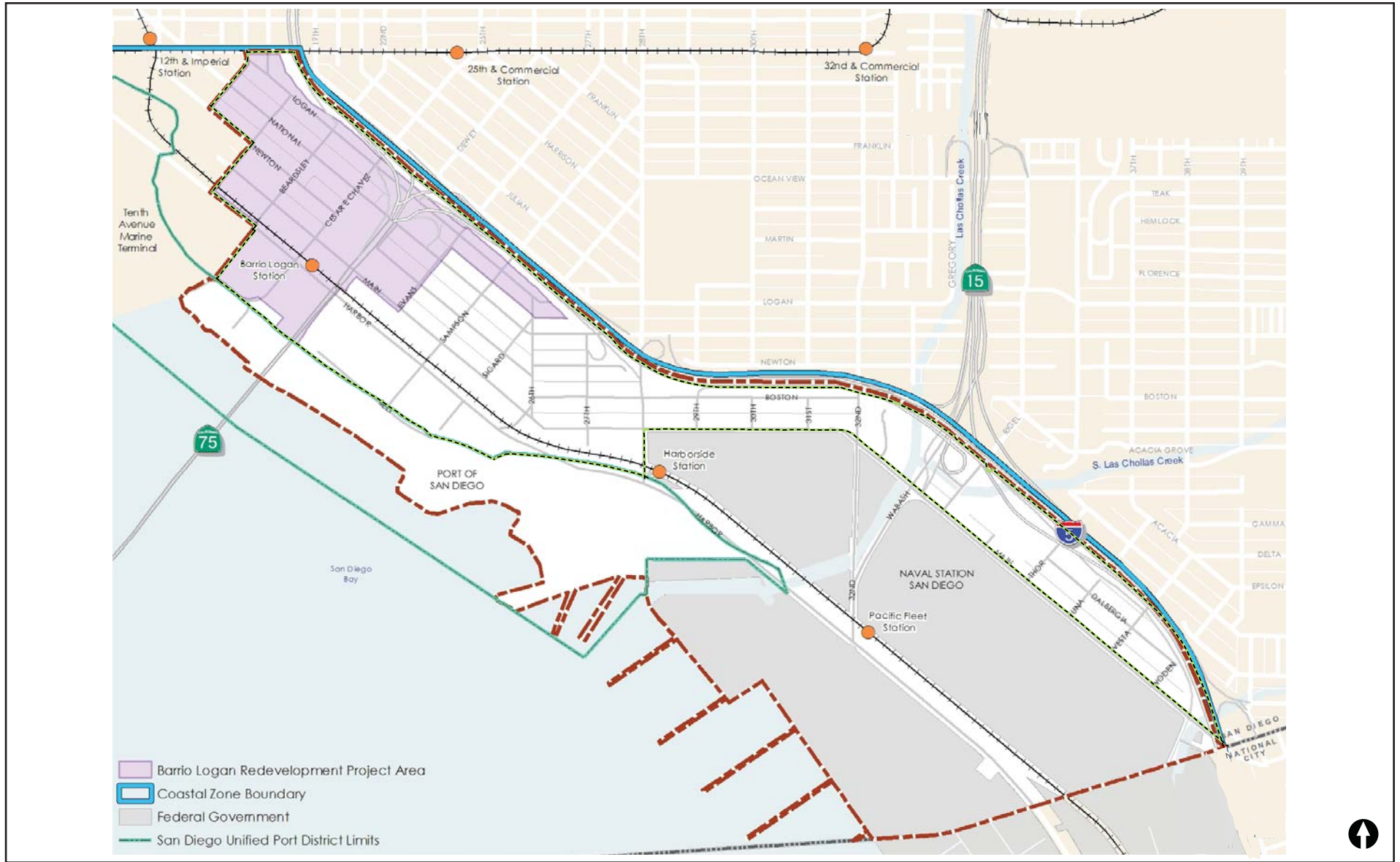

City of San Diego Jurisdictional Lands

FIGURE 4

Regulatory and Jurisdictional Boundaries



- Barrio Logan Community Plan Area
- City of San Diego Jurisdictional Lands
- San Diego Unified Port District Limits

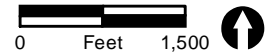

FIGURE 5
 San Diego-1110 Beardsley Street Air Monitoring Station and Memorial Academy Charter School

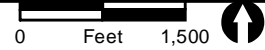
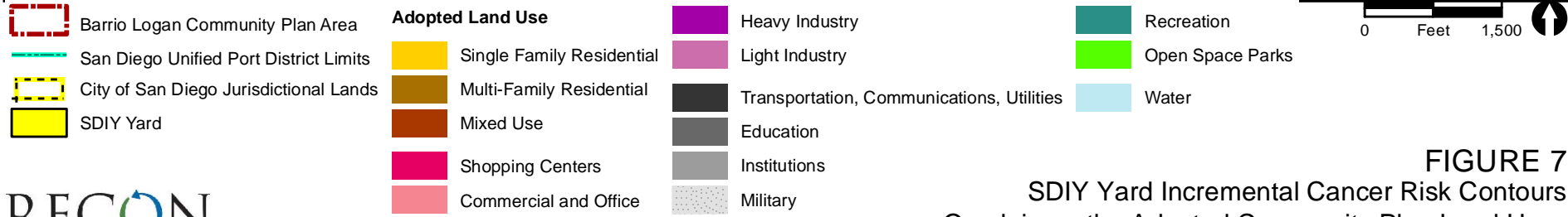
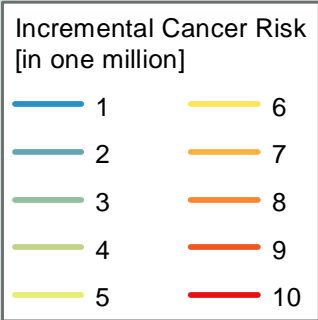
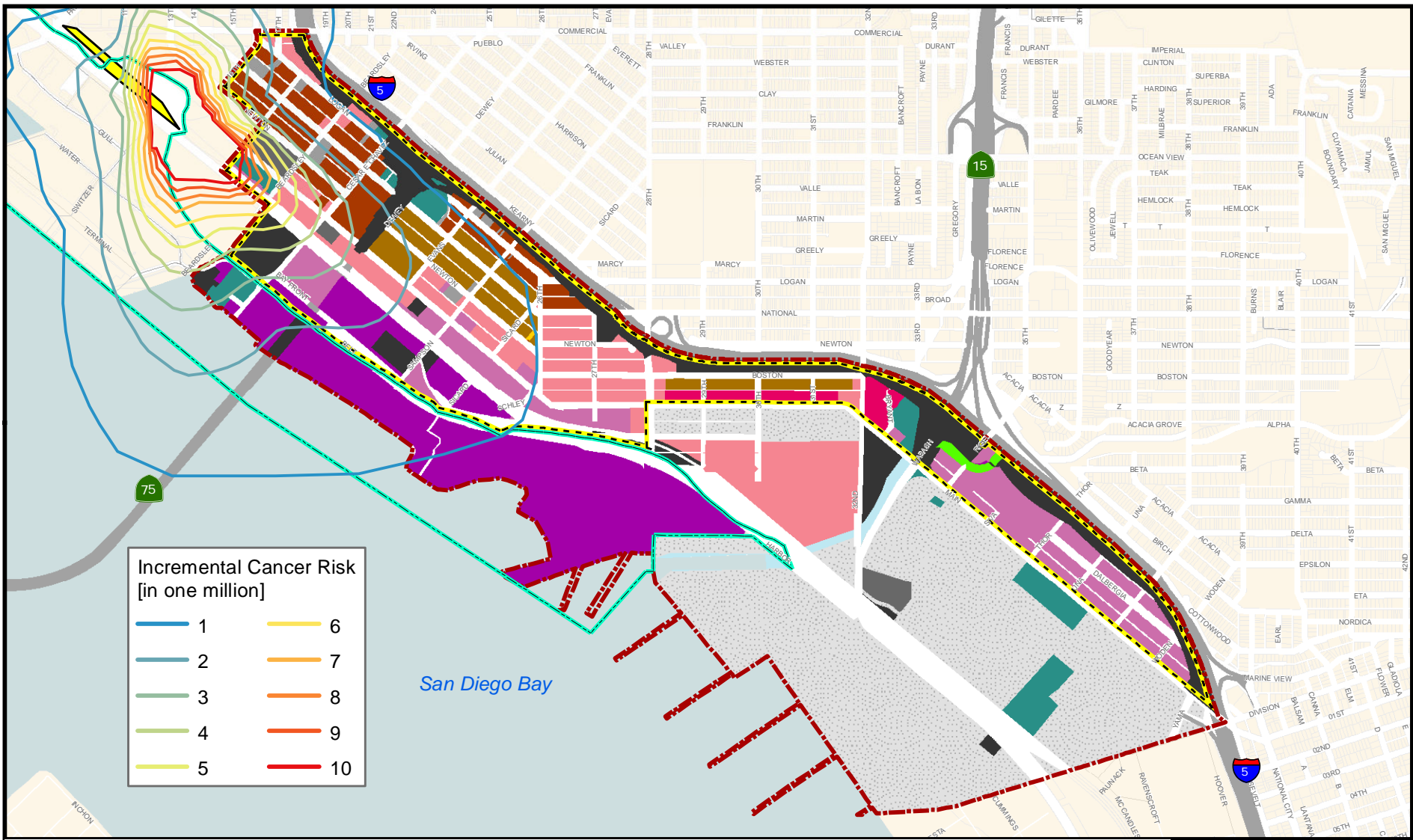
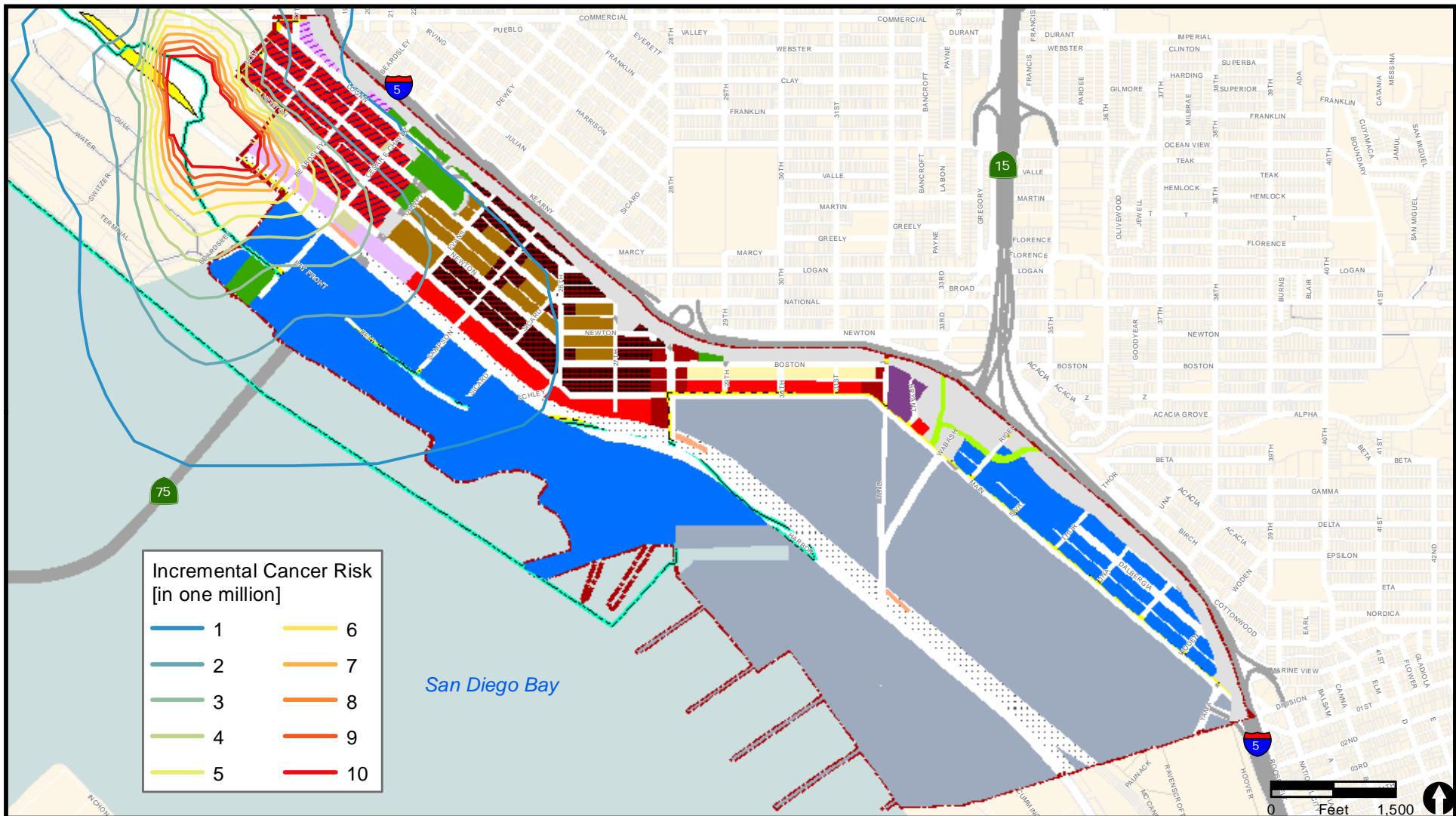

FIGURE 7
SDIY Yard Incremental Cancer Risk Contours
Overlain on the Adopted Community Plan Land Uses



**Incremental Cancer Risk
[in one million]**

1	6
2	7
3	8
4	9
5	10

- | | | | |
|--|--|-------------------------------------|-----------------------|
| Barrio Logan Community Plan Area | Community Plan Land Use Alternative 1 | Office Commercial (Transition Zone) | Open Space |
| City of San Diego Jurisdictional Lands | Community Commercial | Office Commercial | Park |
| San Diego Unified Port District Limits | Community Village | Heavy Industrial | Military Use |
| SDIY Yard | Neighborhood Commercial (Residential Permitted) | Residential Low | Transit Center |
| | Neighborhood Commercial (Residential Prohibited) | Residential Medium | Railroad Right of Way |
| | Heavy Commercial | School/Institutional | Caltrans Right of Way |

FIGURE 8
SDIY Yard Incremental Cancer Risk Contours
Overlay on the Alternative 1 Community Plan Land Uses

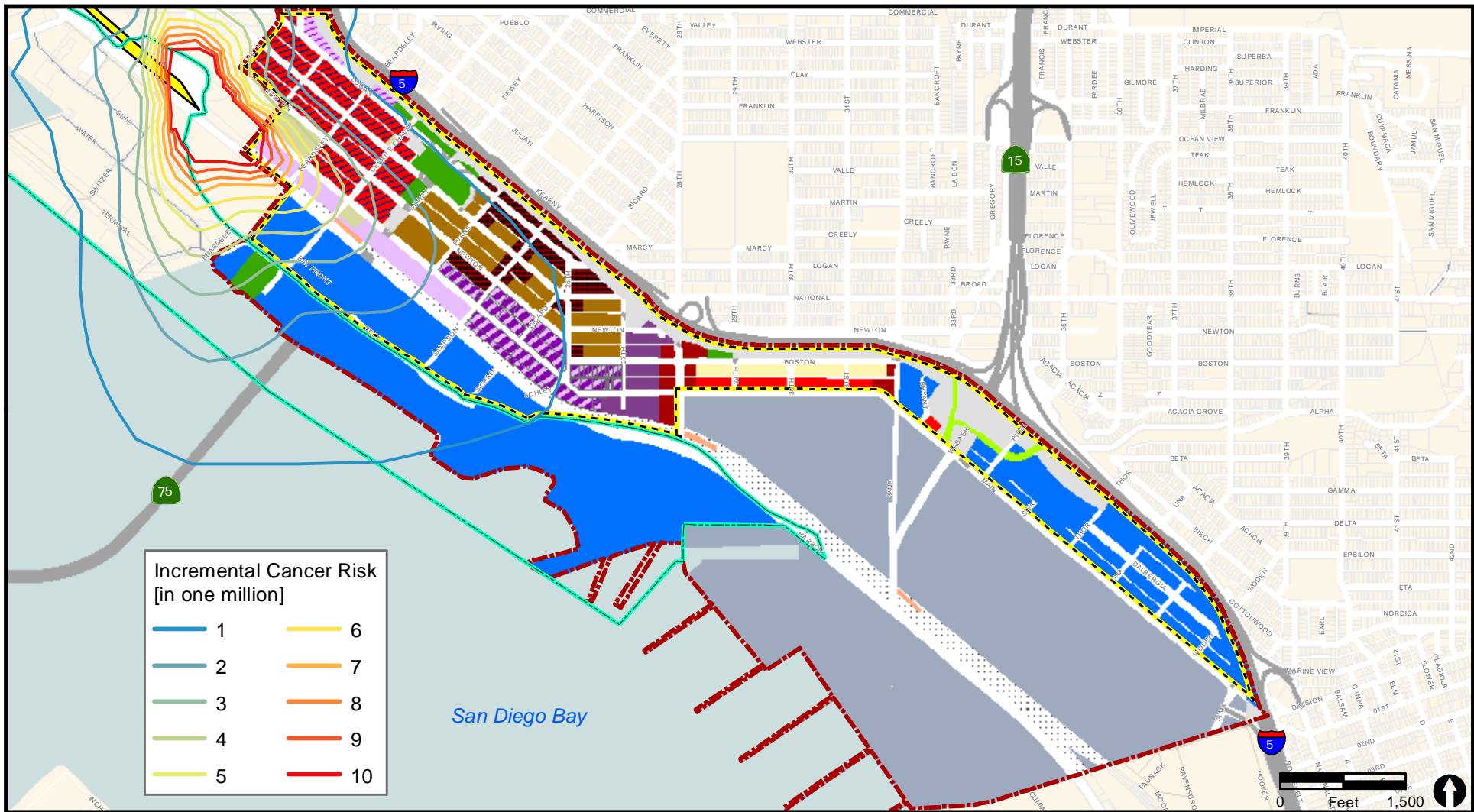
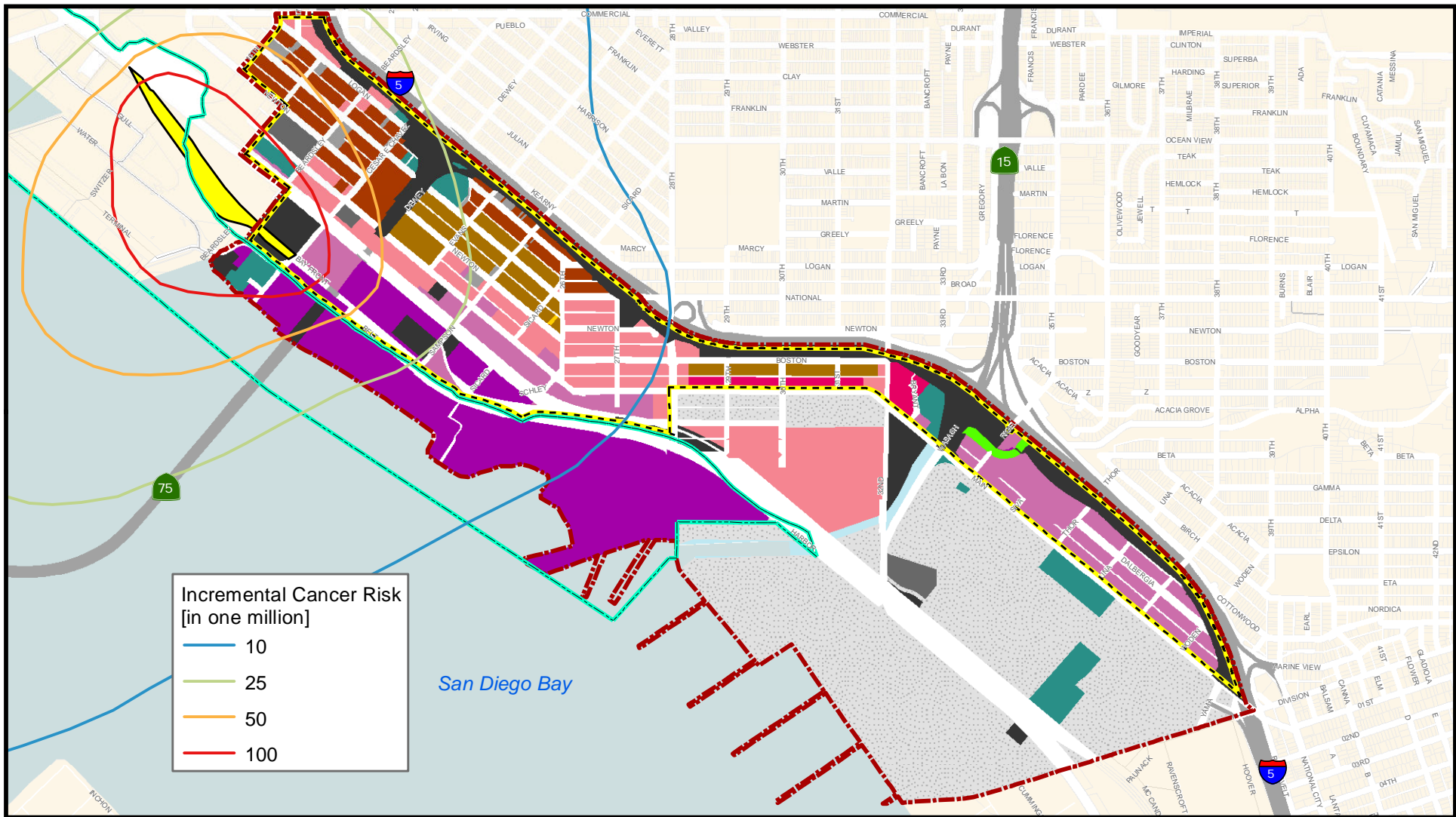

FIGURE 9
 SDIY Yard Incremental Cancer Risk Contours
 Overlain on the Revised Alternative 2 Community Plan Land Uses



Incremental Cancer Risk
[in one million]

- 10
- 25
- 50
- 100

- Barrio Logan Community Plan Area
- City of San Diego Jurisdictional Lands
- San Diego Unified Port District Limits
- BNSF Yard

- Adopted Land Use**
- Single Family Residential
 - Multi-Family Residential
 - Mixed Use
 - Shopping Centers
 - Commercial and Office

- Heavy Industry
- Light Industry
- Transportation, Communications, Utilities
- Education
- Institutions
- Military

- Recreation
- Open Space Parks
- Water

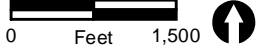

FIGURE 10
BNSF Yard Incremental Cancer Risk Contours
Overlain on the Adopted Community Plan Land Uses

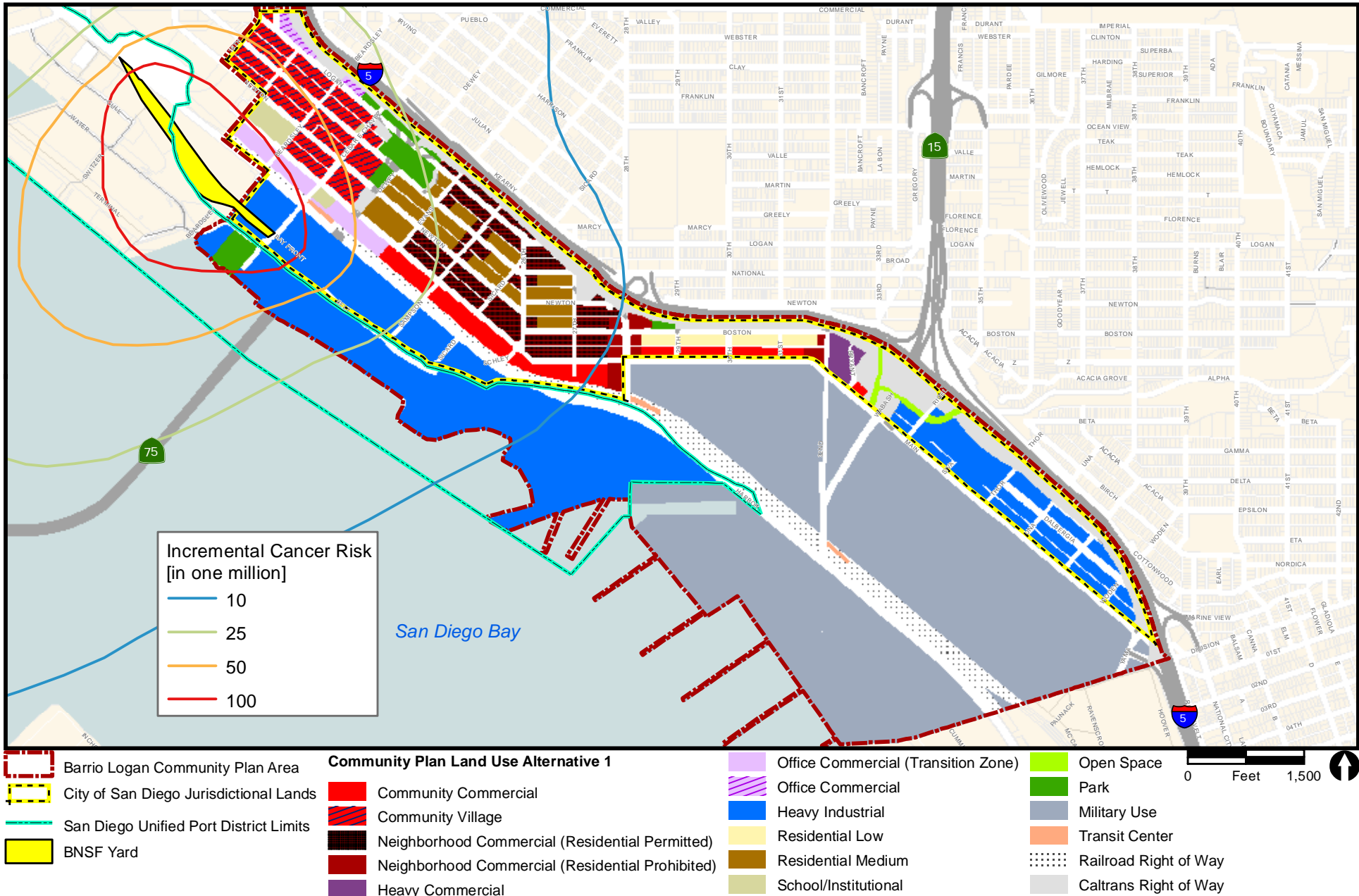

FIGURE 11
BNSF Yard Incremental Cancer Risk Contours
Overlain on the Alternative 1 Community Plan Land Uses

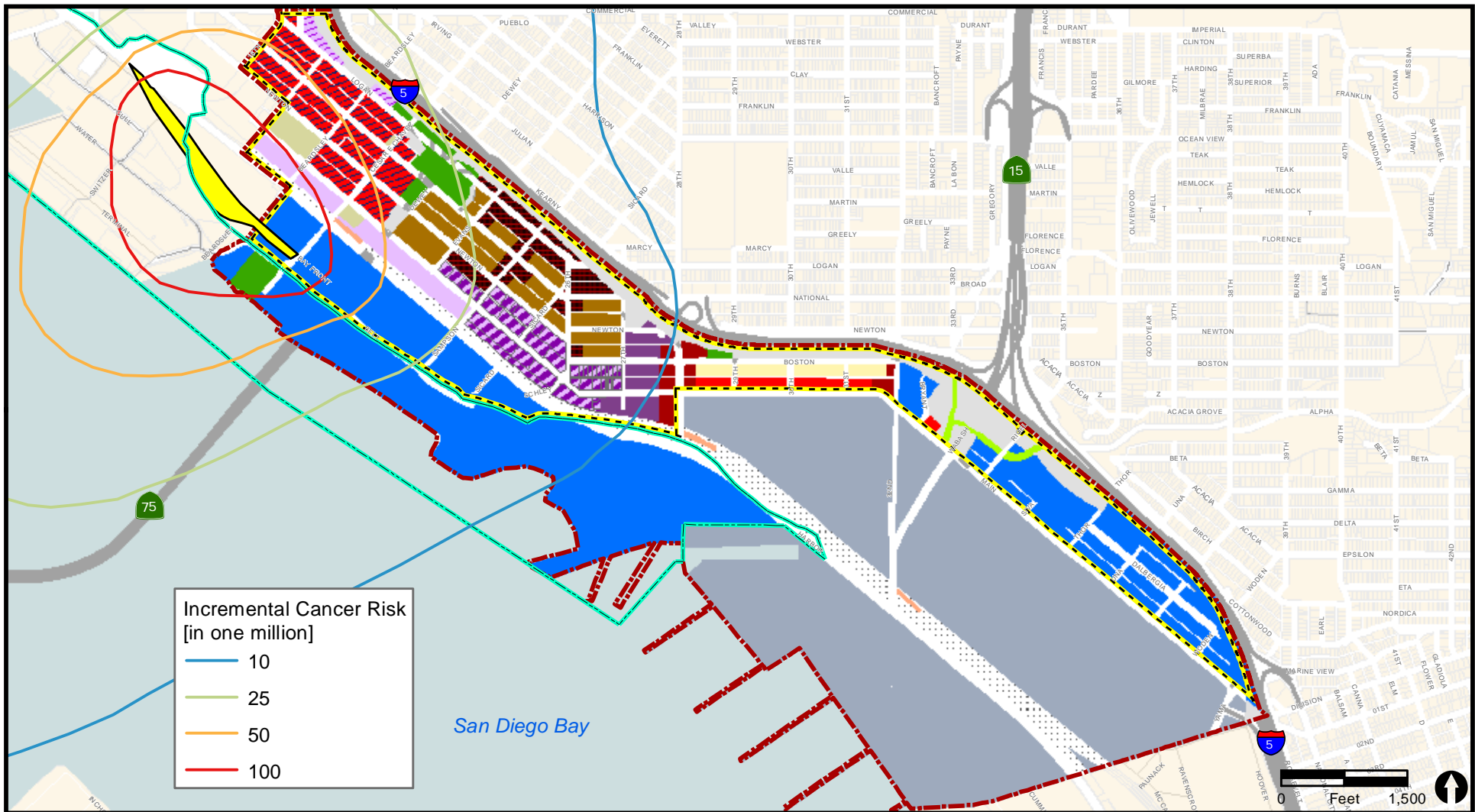
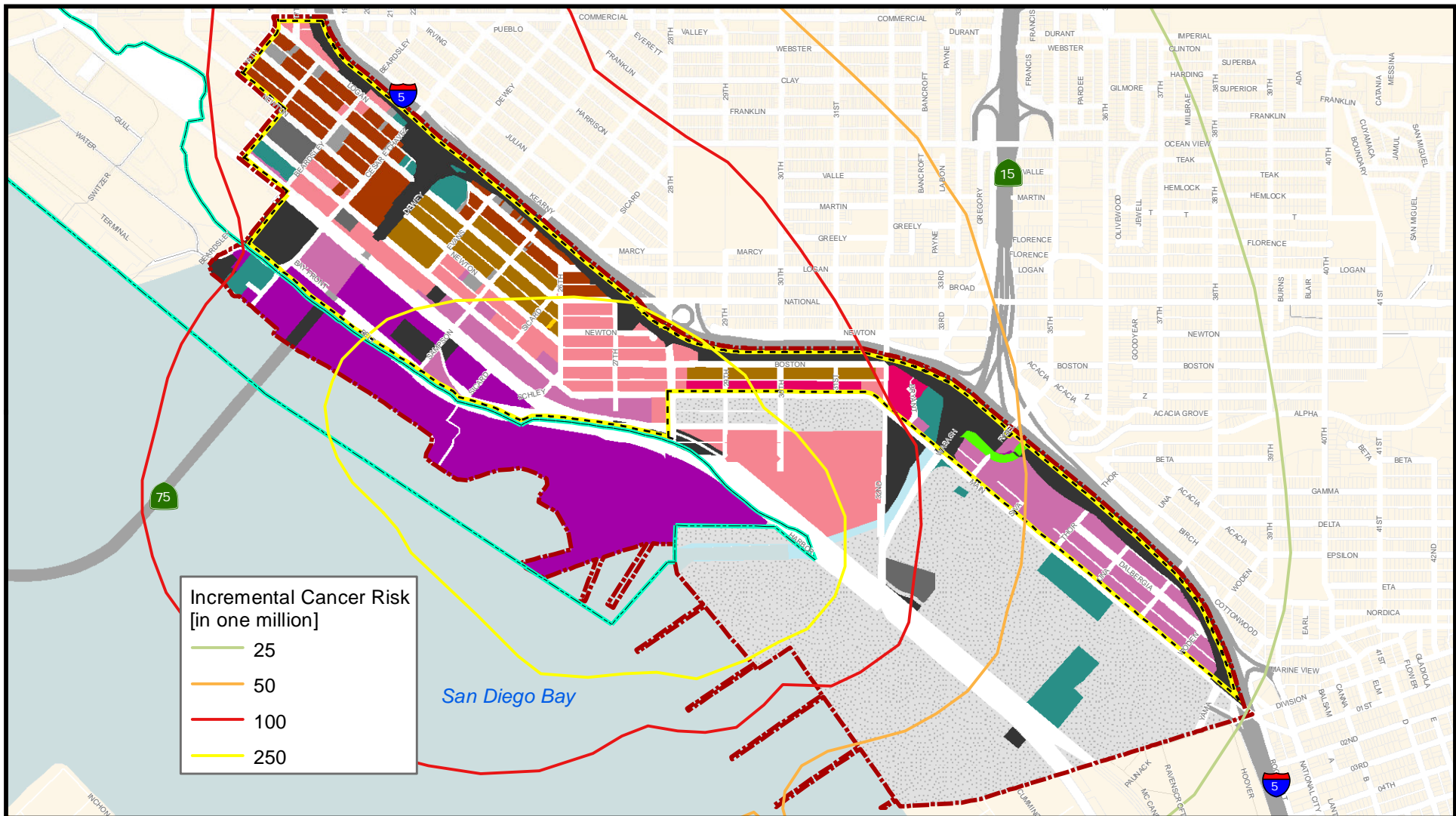

FIGURE 12
BNSF Yard Incremental Cancer Risk Contours
 Overlain on the Revised Alternative 2 Community Plan Land Uses



**Incremental Cancer Risk
[in one million]**

- 25
- 50
- 100
- 250

- Barrio Logan Community Plan Area
- City of San Diego Jurisdictional Lands
- San Diego Unified Port District Limits

Adopted Land Use

- Single Family Residential
- Multi-Family Residential
- Mixed Use
- Shopping Centers
- Commercial and Office

- Heavy Industry
- Light Industry
- Transportation, Communications, Utilities
- Education
- Institutions
- Military

- Recreation
- Open Space Parks
- Water

0 Feet 1,500

FIGURE 13
BNSF Yard Study Off-Site Incremental Cancer Risk Contours
Overlain on the Adopted Community Plan Land Uses

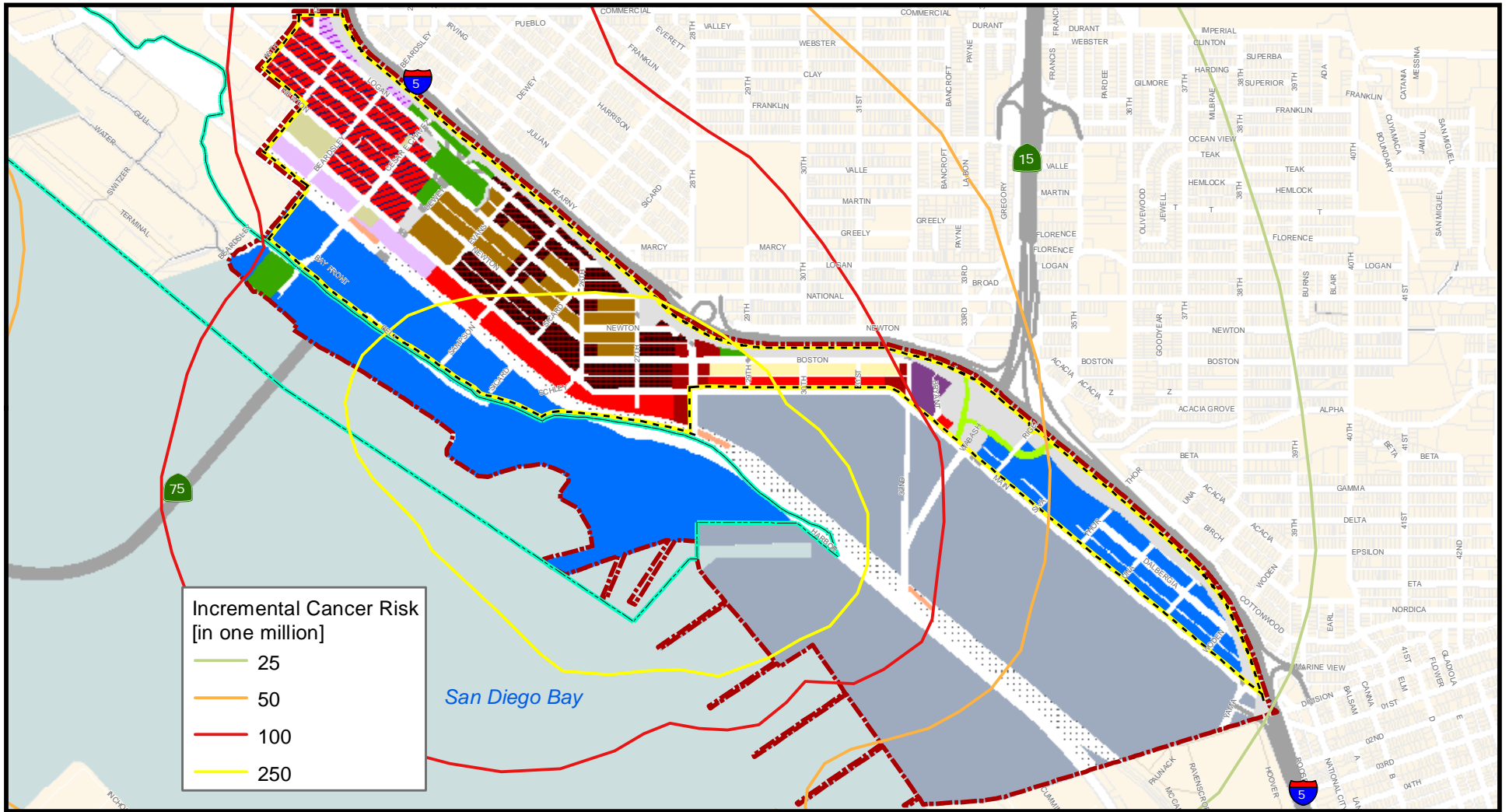

Incremental Cancer Risk
[in one million]

- 25
- 50
- 100
- 250

- | | | | |
|--|--|-------------------------------------|-----------------------|
| Barrio Logan Community Plan Area | Community Plan Land Use Alternative 1 | Office Commercial (Transition Zone) | Open Space |
| City of San Diego Jurisdictional Lands | Community Commercial | Office Commercial | Park |
| San Diego Unified Port District Limits | Community Village | Heavy Industrial | Military Use |
| | Neighborhood Commercial (Residential Permitted) | Residential Low | Transit Center |
| | Neighborhood Commercial (Residential Prohibited) | Residential Medium | Railroad Right of Way |
| | Heavy Commercial | School/Institutional | Caltrans Right of Way |

0 Feet 1,500

FIGURE 14

BNSF Yard Study Off-Site Incremental Cancer Risk Contours
Overlain on the Alternative 1 Community Plan Land Uses

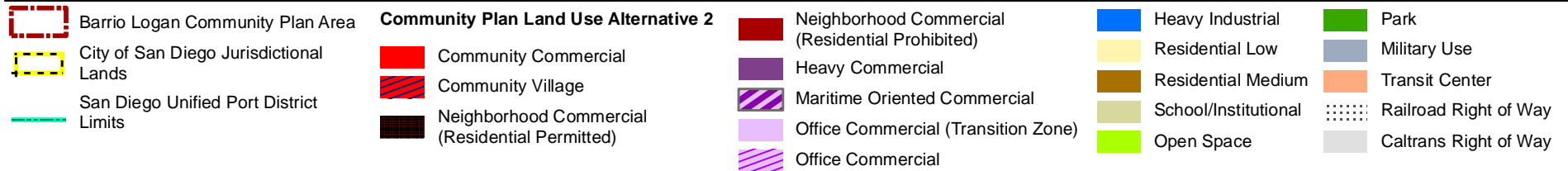
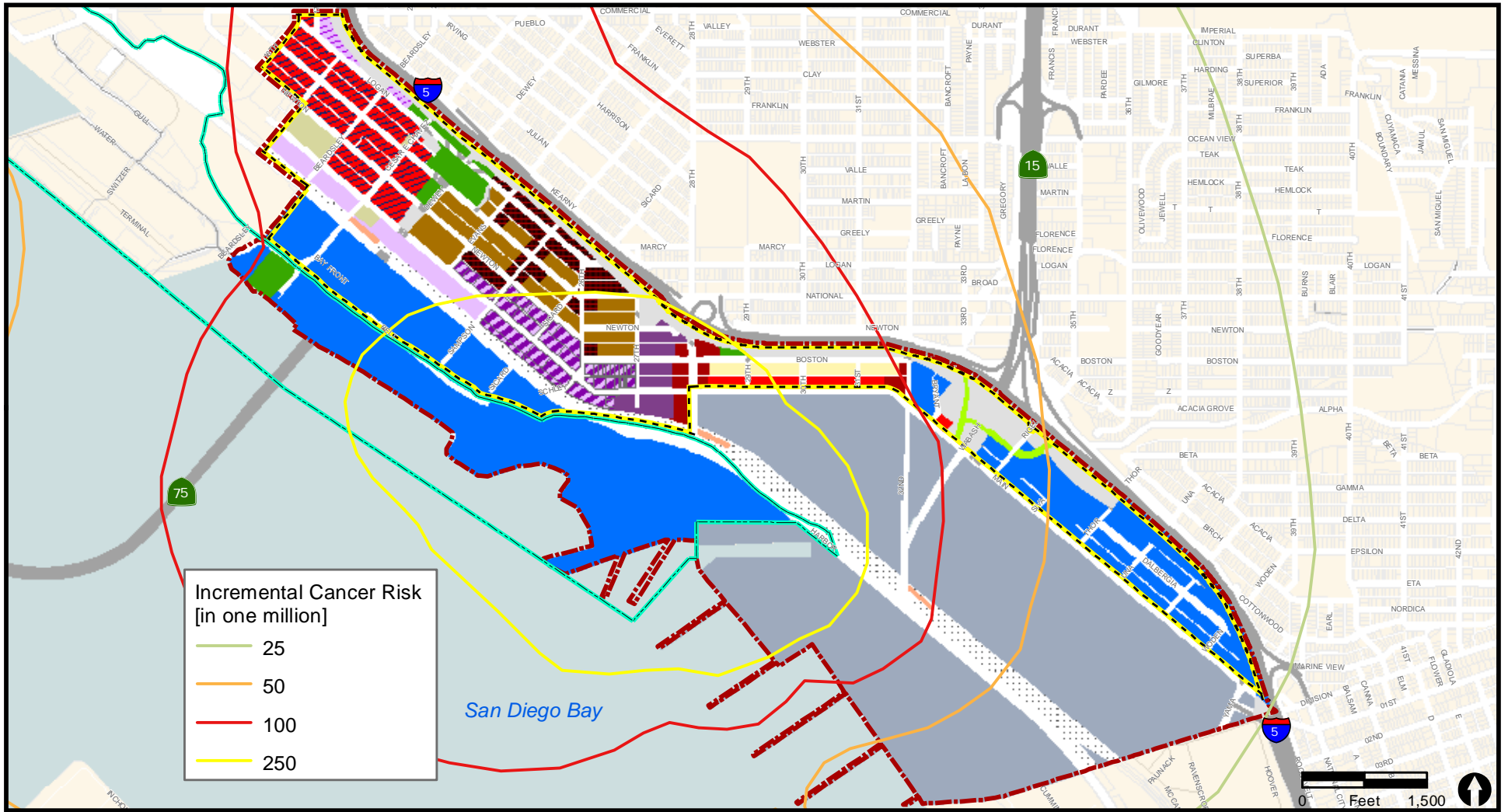

FIGURE 15
 BNSF Yard Study Off-Site Incremental Cancer Risk Contours
 Overlain on the Revised Alternative 2 Community Plan Land Uses

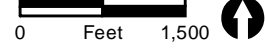
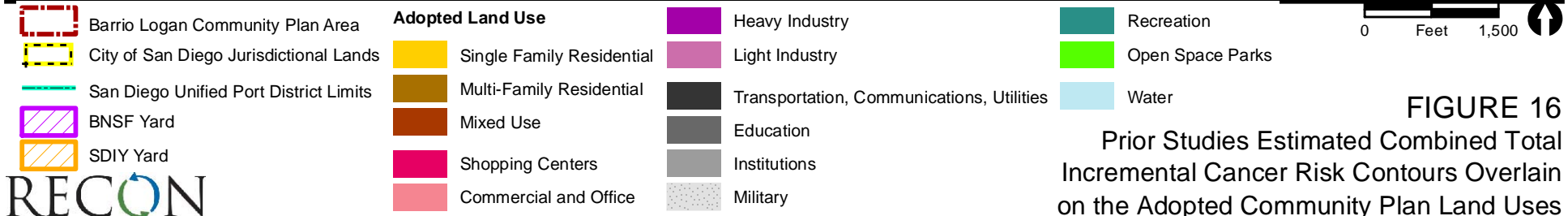
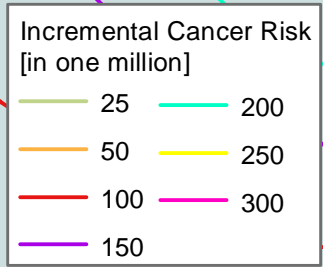
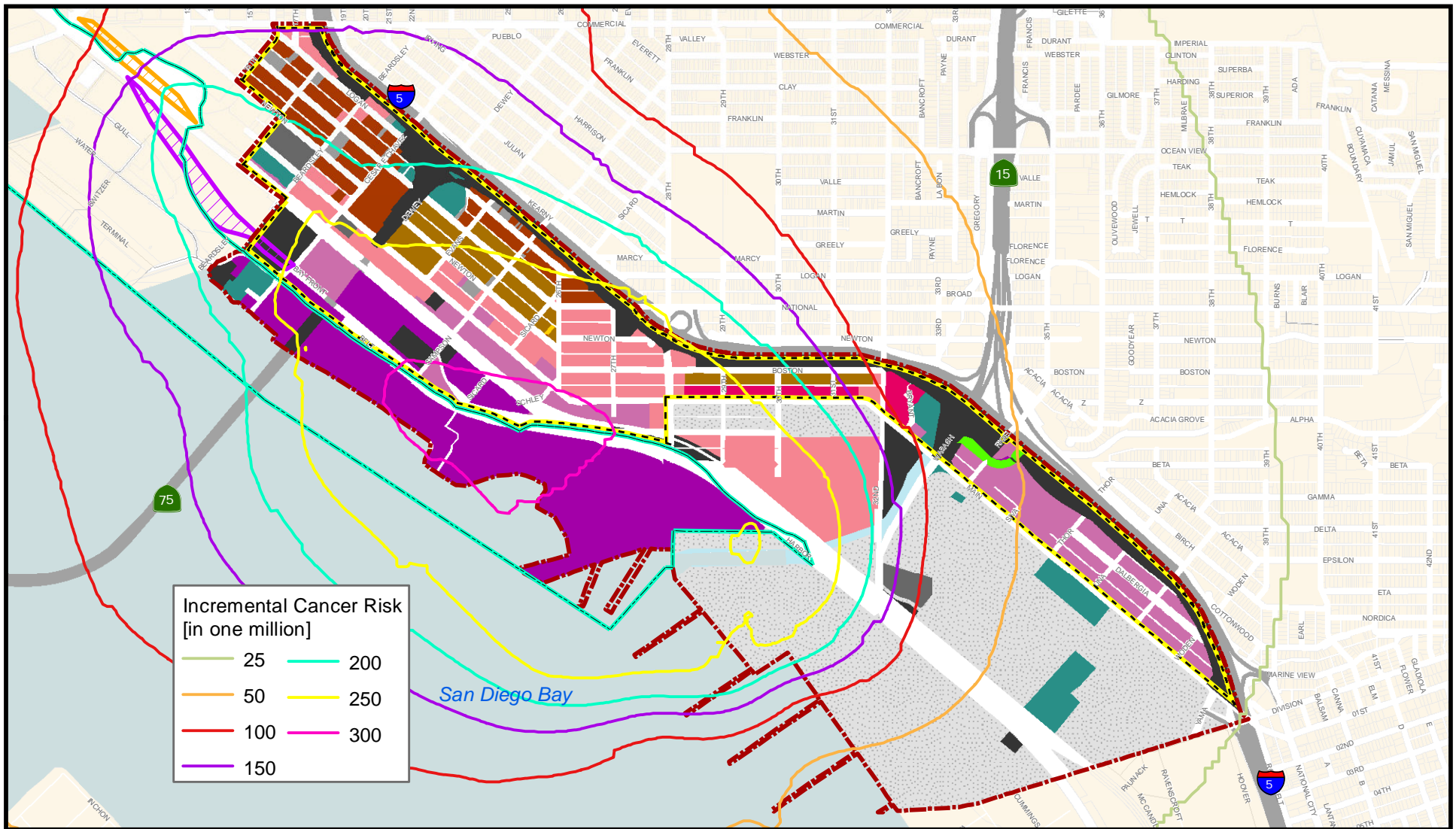

FIGURE 16
 Prior Studies Estimated Combined Total Incremental Cancer Risk Contours Overlain on the Adopted Community Plan Land Uses

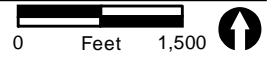
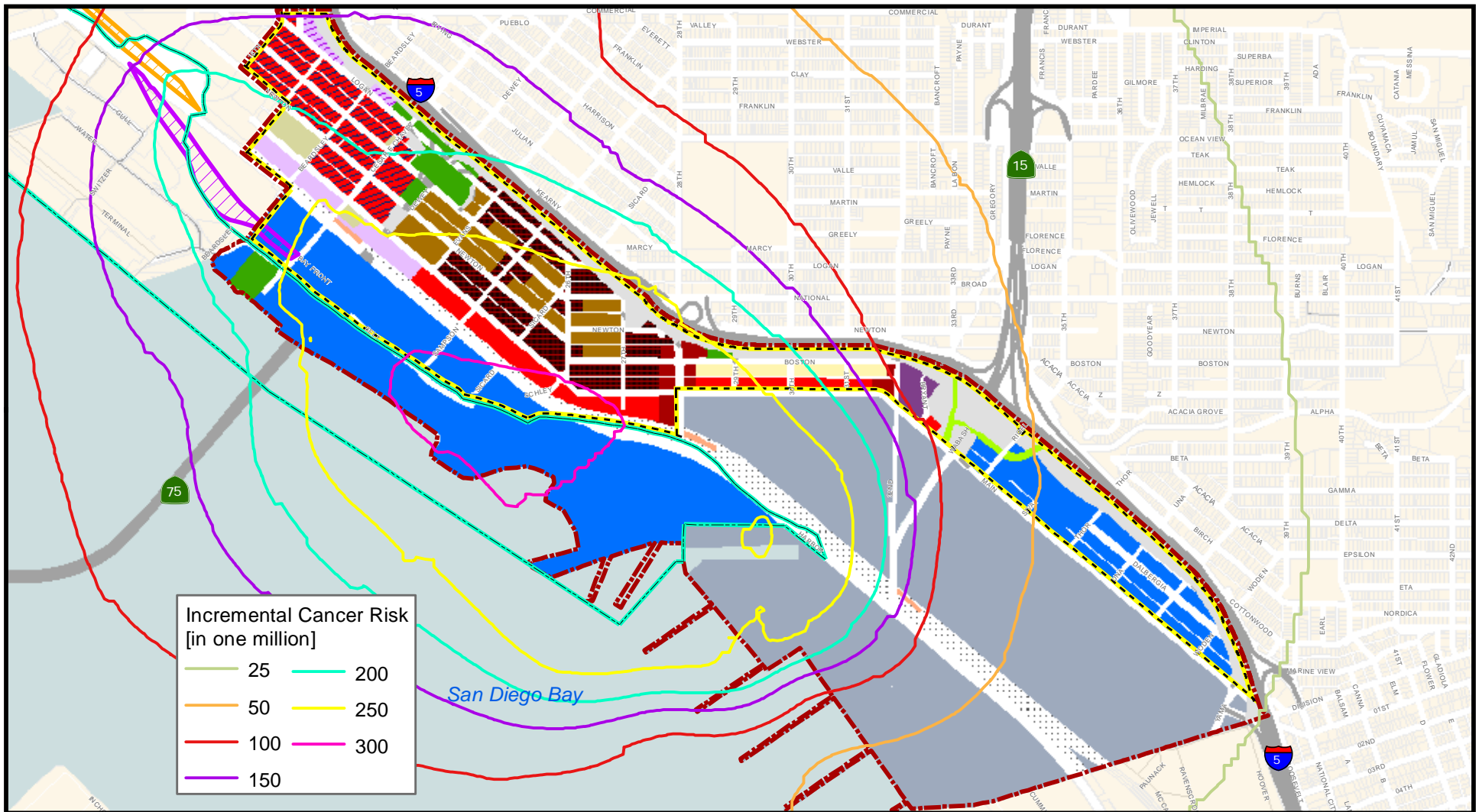
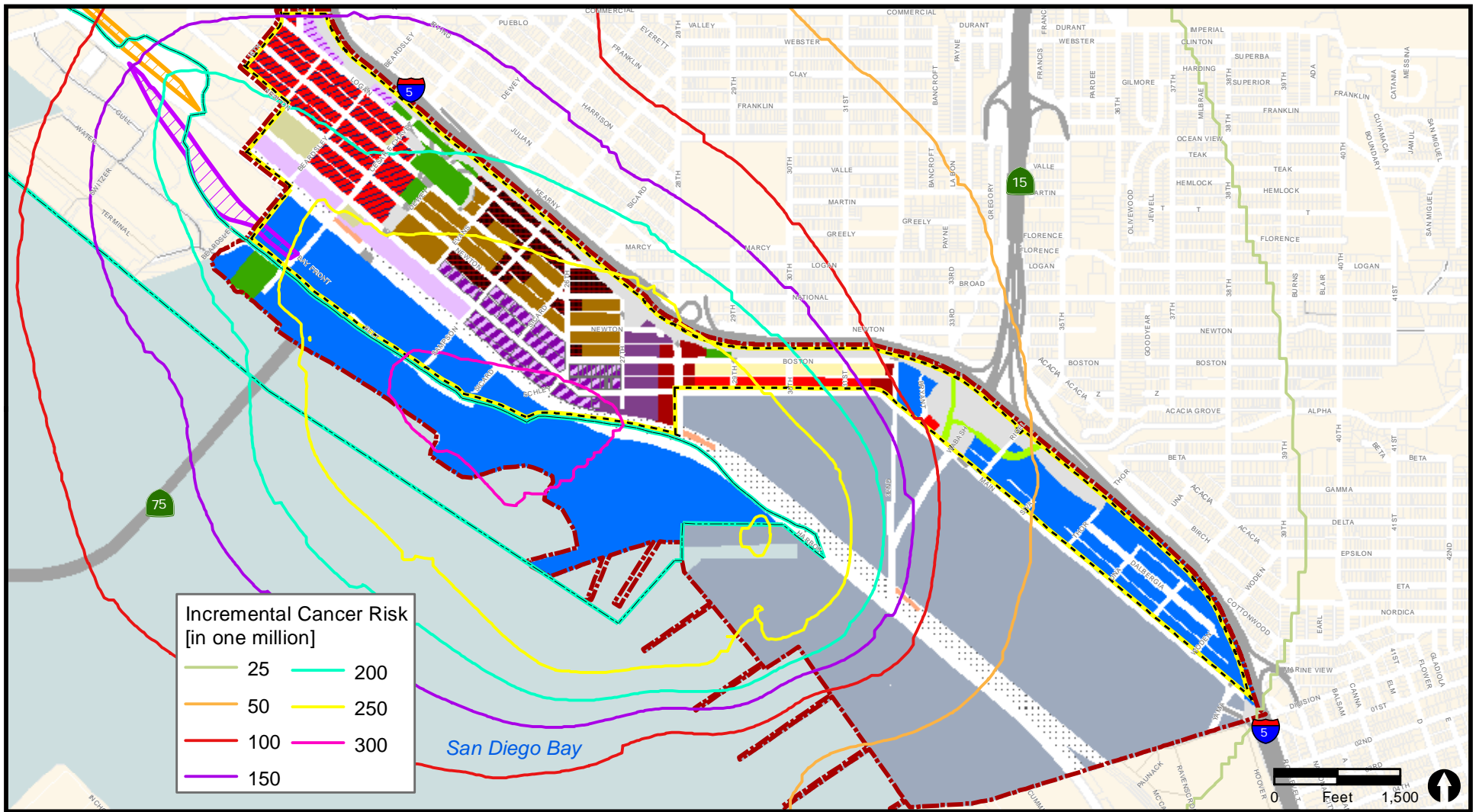

FIGURE 17
 Prior Studies Estimated Combined Total Incremental Cancer Risk
 Contours Overlain on the Alternative 1 Community Plan Land Uses



Incremental Cancer Risk [in one million]

25	200
50	250
100	300
150	

- | | | | | |
|--|---|--|----------------------|-----------------------|
| Barrio Logan Community Plan Area | Community Plan Land Use Alternative 2 | Neighborhood Commercial (Residential Prohibited) | Heavy Industrial | Park |
| City of San Diego Jurisdictional Lands | Community Commercial | Heavy Commercial | Residential Low | Military Use |
| San Diego Unified Port District Limits | Community Village | Maritime Oriented Commercial | Residential Medium | Transit Center |
| | Neighborhood Commercial (Residential Permitted) | Office Commercial (Transition Zone) | School/Institutional | Railroad Right of Way |
| | | Office Commercial | Open Space | Caltrans Right of Way |

FIGURE 18

Prior Studies Estimated Combined Total Incremental Cancer Risk Contours Overlain on the Revised Alternative 2 Community Plan Land Uses

WIND ROSE PLOT:

Station #23188
SAN DIEGO/LINDBERGH FIELD

DISPLAY:

Wind Speed
Direction (blowing from)

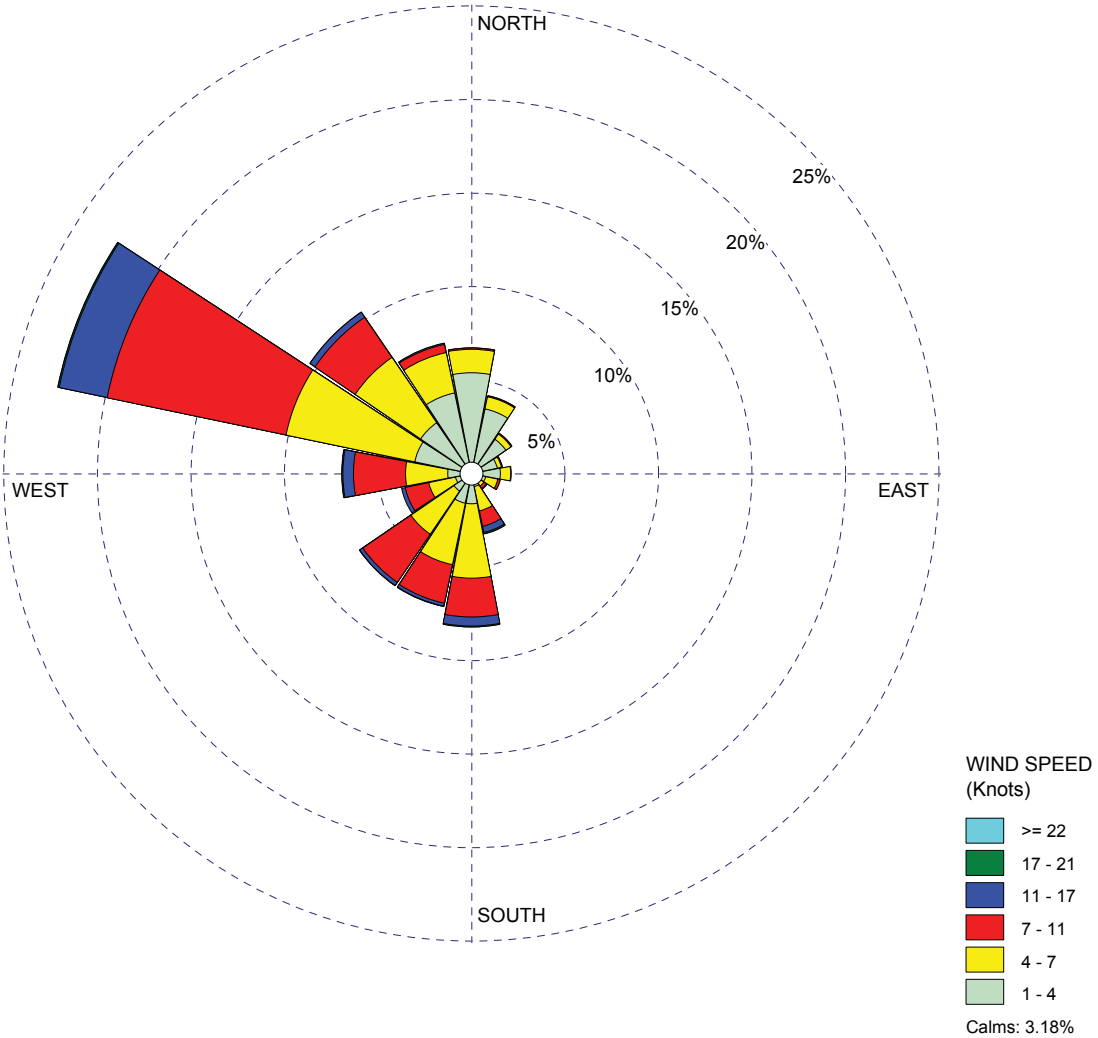

COMMENTS:

DATA PERIOD:

2006-2010
Jan 1 - Dec 31
00:00 - 23:00

COMPANY NAME:

RECON Environmental

MODELER:

David M. Gottfredson

CALM WINDS:

3.18%

TOTAL COUNT:

43688 hrs.

AVG. WIND SPEED:

5.60 Knots

DATE:

6/1/2011

PROJECT NO.:





4617

WRPLOT View - Lakes Environmental Software

FIGURE 19

Surface Wind Rose for Lindbergh Field 2006 to 2010



-  Barrio Logan Community Plan Area
-  City of San Diego Jurisdictional Lands
-  San Diego Unified Port District Limits
-  Modeled Freeway Segments
-  Modeled Receivers



0 Feet 1,500 

FIGURE 20
 Modeled Freeway Receivers and Freeway Segments – Proposed CPU Alternatives 1 and 2



-  Barrio Logan Community Plan Area
-  City of San Diego Jurisdictional Lands
-  San Diego Unified Port District Limits
-  Modeled Freeway Segments
-  Modeled Receivers

0 Feet 1,500 

FIGURE 21
 Modeled Freeway Receivers and Freeway
 Segments – Adopted Community Plan



- Barrio Logan Community Plan Area
- City of San Diego Jurisdictional Lands
- San Diego Unified Port District Limits
- MEIR

- Adopted Land Use**
- Single Family Residential
 - Multi-Family Residential
 - Mixed Use
 - Shopping Centers
 - Commercial and Office

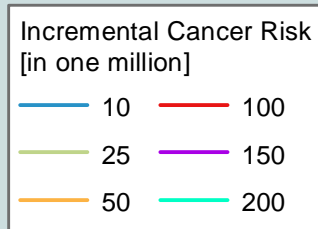
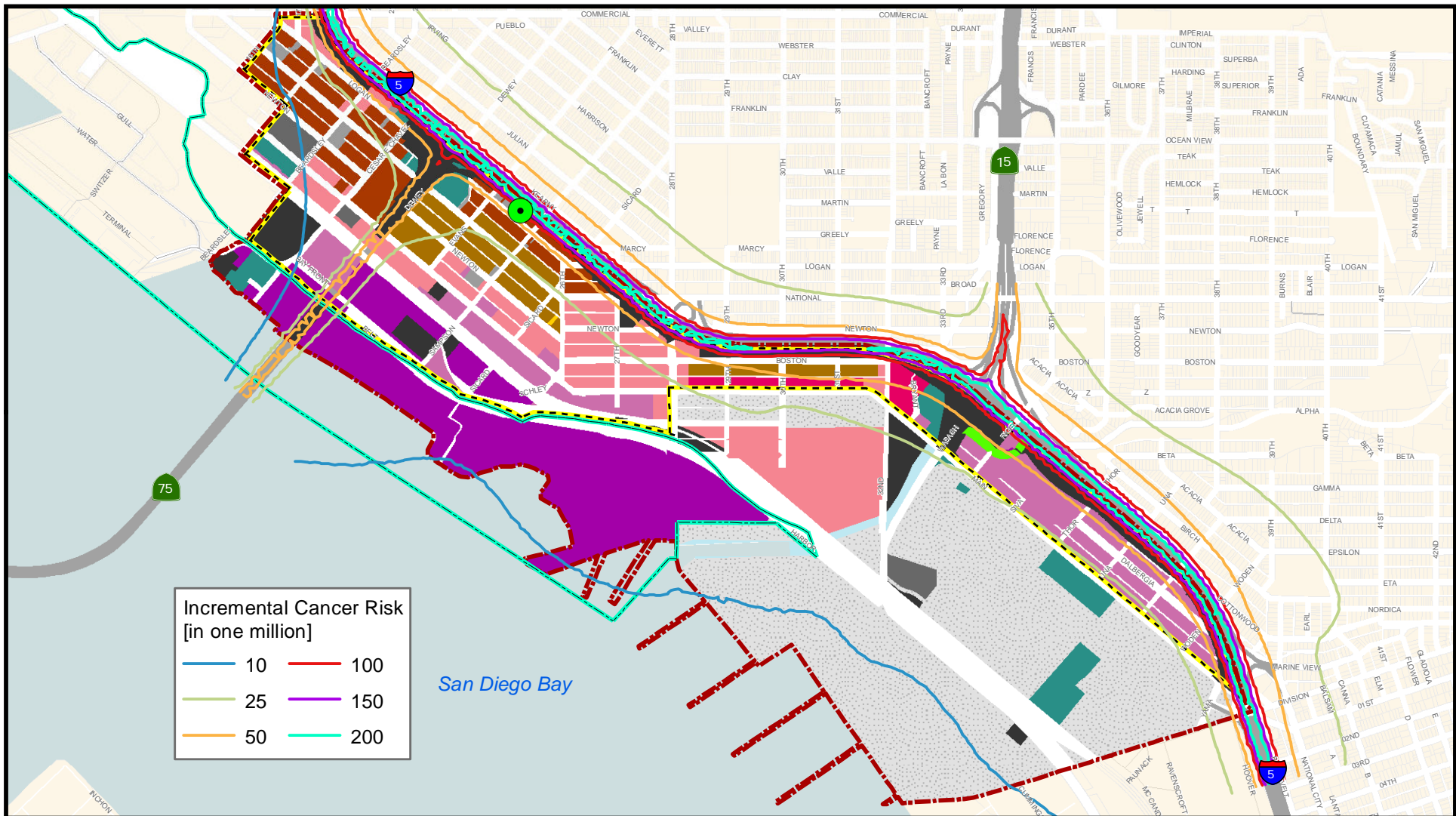
- Heavy Industry
- Light Industry
- Transportation, Communications, Utilities
- Education
- Institutions
- Military

- Recreation
- Open Space Parks
- Water

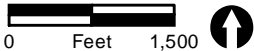
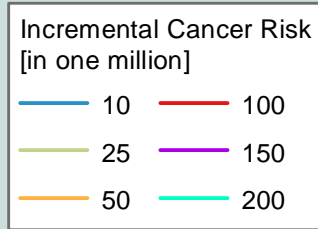
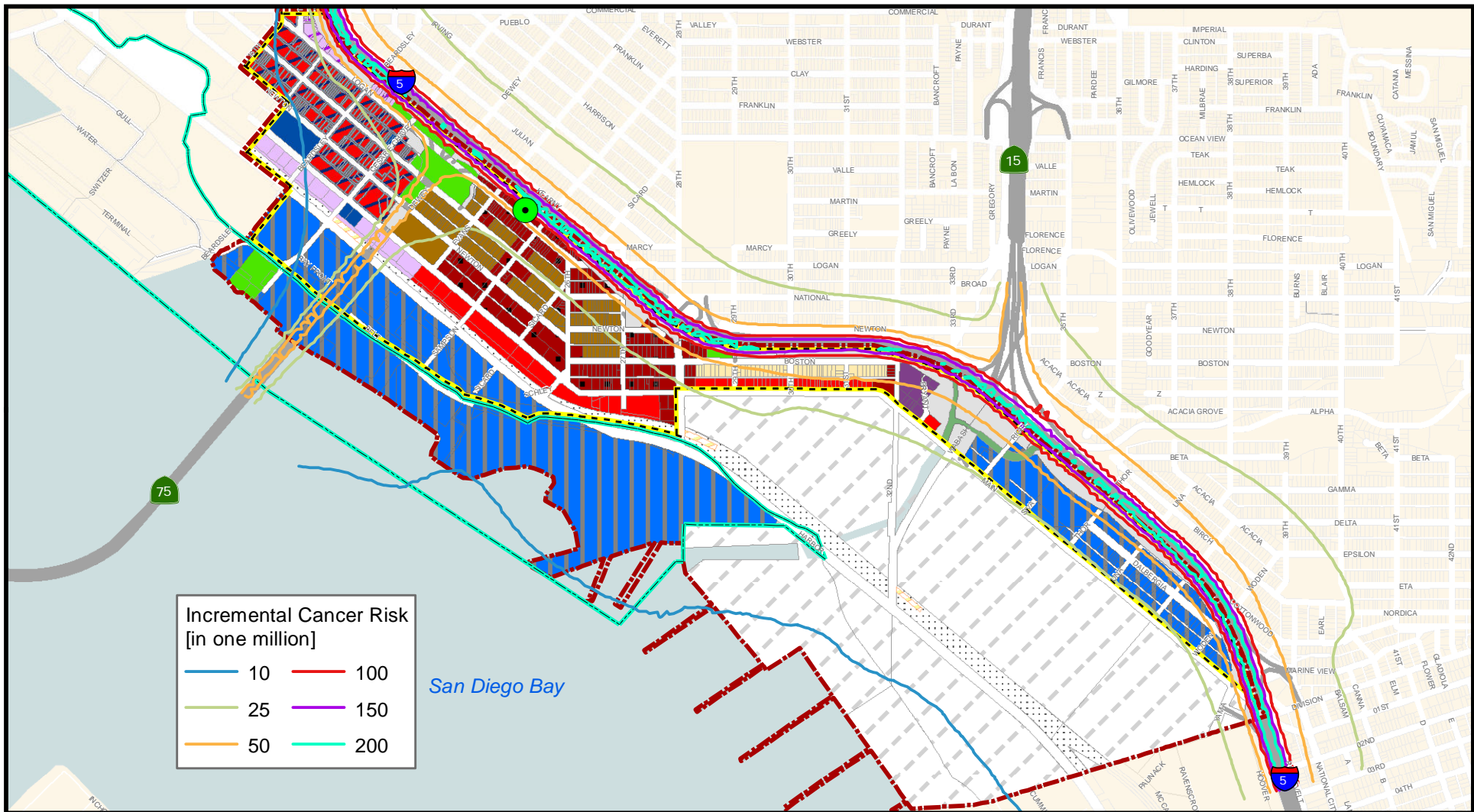

FIGURE 22
 Diesel Particulate 80th Percentile Residential
 Incremental Cancer Risk Contours due to Freeway
 Traffic Overlain on the Adopted Community Plan Land Uses



- Barrio Logan Community Plan Area
- City of San Diego Jurisdictional Lands
- San Diego Unified Port District Limits
- MEIR

- Community Plan Land Use Alternative 1**
- Community Commercial
 - Community Village
 - Neighborhood Commercial (Residential Permitted)
 - Neighborhood Commercial (Residential Prohibited)
 - Heavy Commercial
 - Office Commercial (3 stories)

- Office Commercial (4-5 stories)
- Prime Industrial
- Residential Low
- Residential Medium
- Live/Work (4-5 stories)
- School/Institutional
- Open Space
- Park
- Military Use
- Transit Center
- Railroad Right of Way
- Caltrans Right of Way

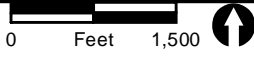

FIGURE 23
 Diesel Particulate 80th Percentile Residential
 Incremental Cancer Risk Contours due to Freeway
 Traffic Overlain on the Alternative 1 Community Plan Land Uses

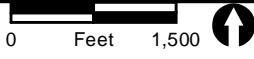
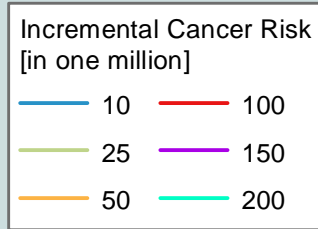
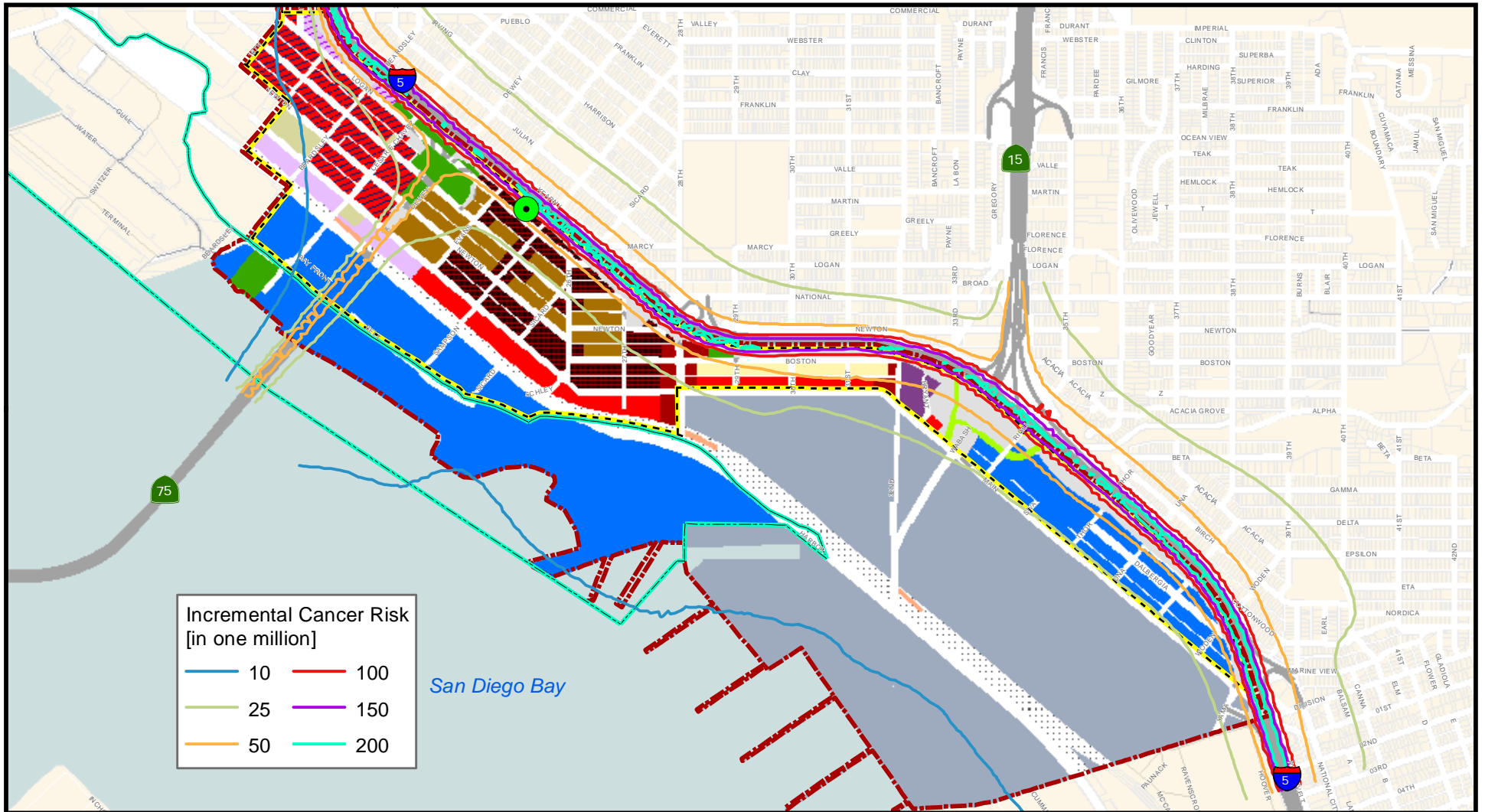

FIGURE 23

Diesel Particulate 80th Percentile Residential Incremental Cancer Risk Contours due to Freeway Traffic Overlain on the Alternative 1 Community Plan Land Uses

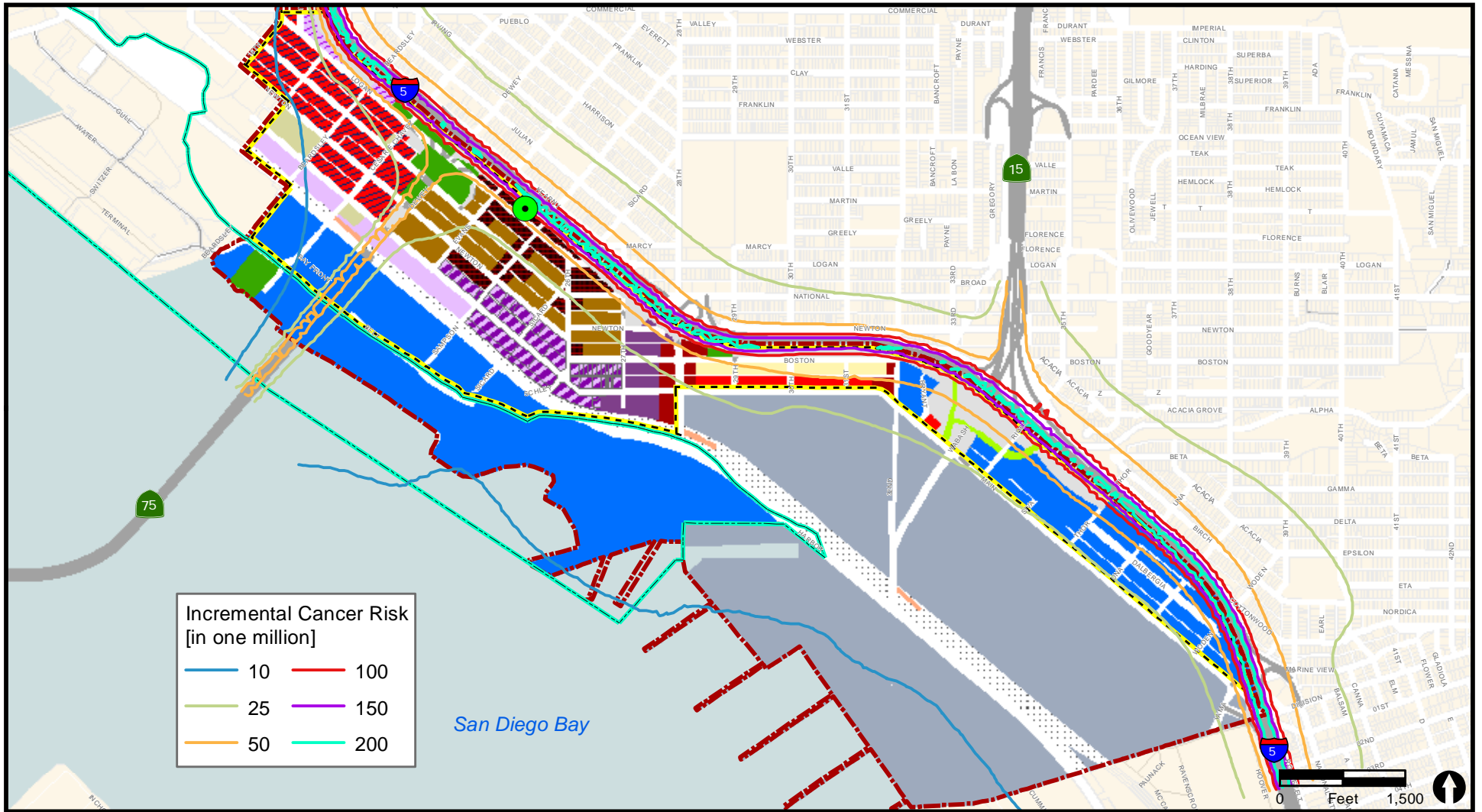
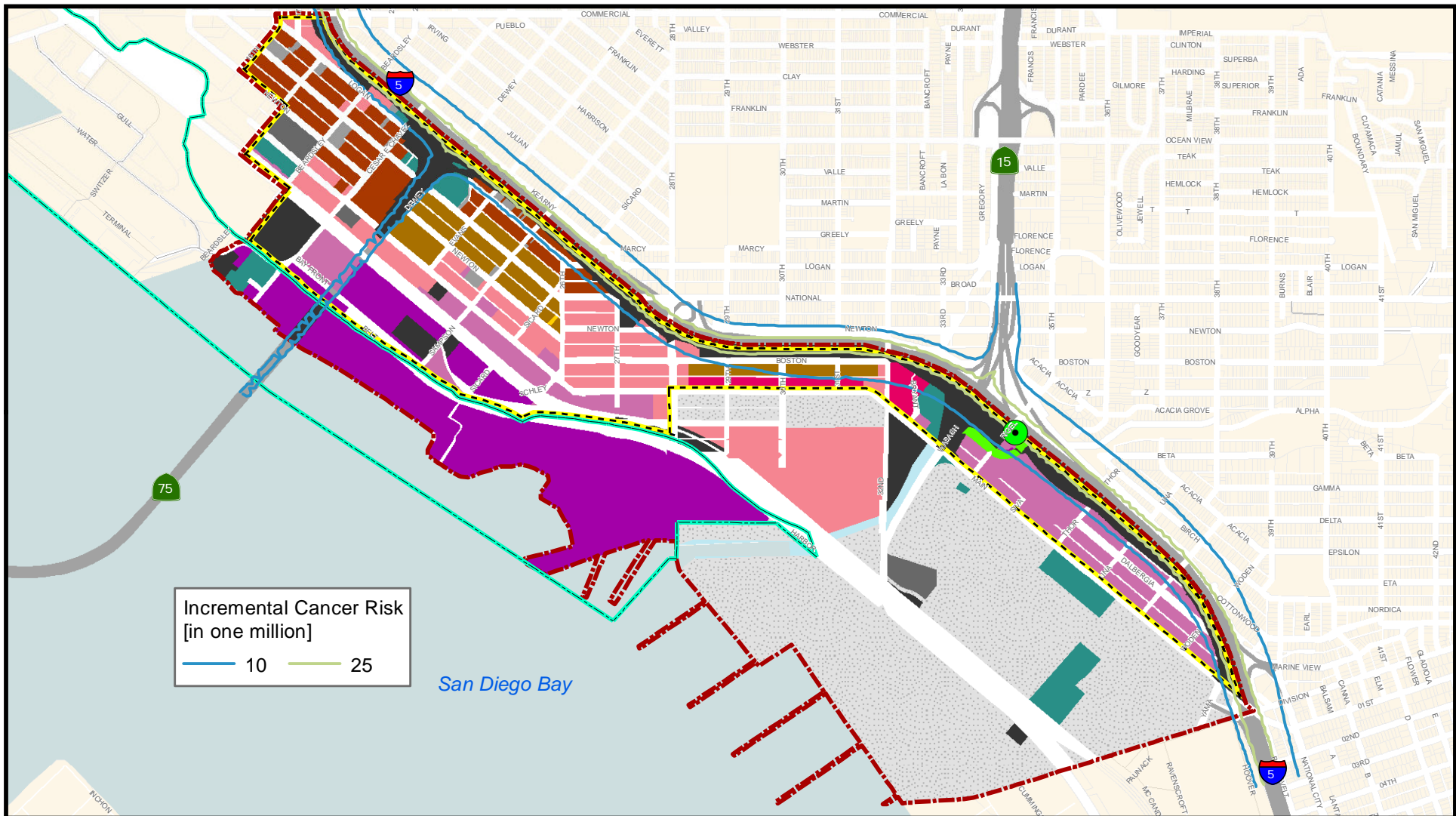

FIGURE 24

Diesel Particulate 80th Percentile Residential Incremental Cancer Risk Contours due to Freeway Traffic Overlain on the Revised Alternative 2 Community Plan Land Uses



Incremental Cancer Risk
[in one million]

— 10 — 25

San Diego Bay

- Barrio Logan Community Plan Area
- City of San Diego Jurisdictional Lands
- San Diego Unified Port District Limits
- MEIW

- Adopted Land Use**
- Single Family Residential
 - Multi-Family Residential
 - Mixed Use
 - Shopping Centers
 - Commercial and Office

- Heavy Industry
- Light Industry
- Transportation, Communications, Utilities
- Education
- Institutions
- Military

- Recreation
- Open Space Parks
- Water

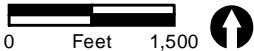
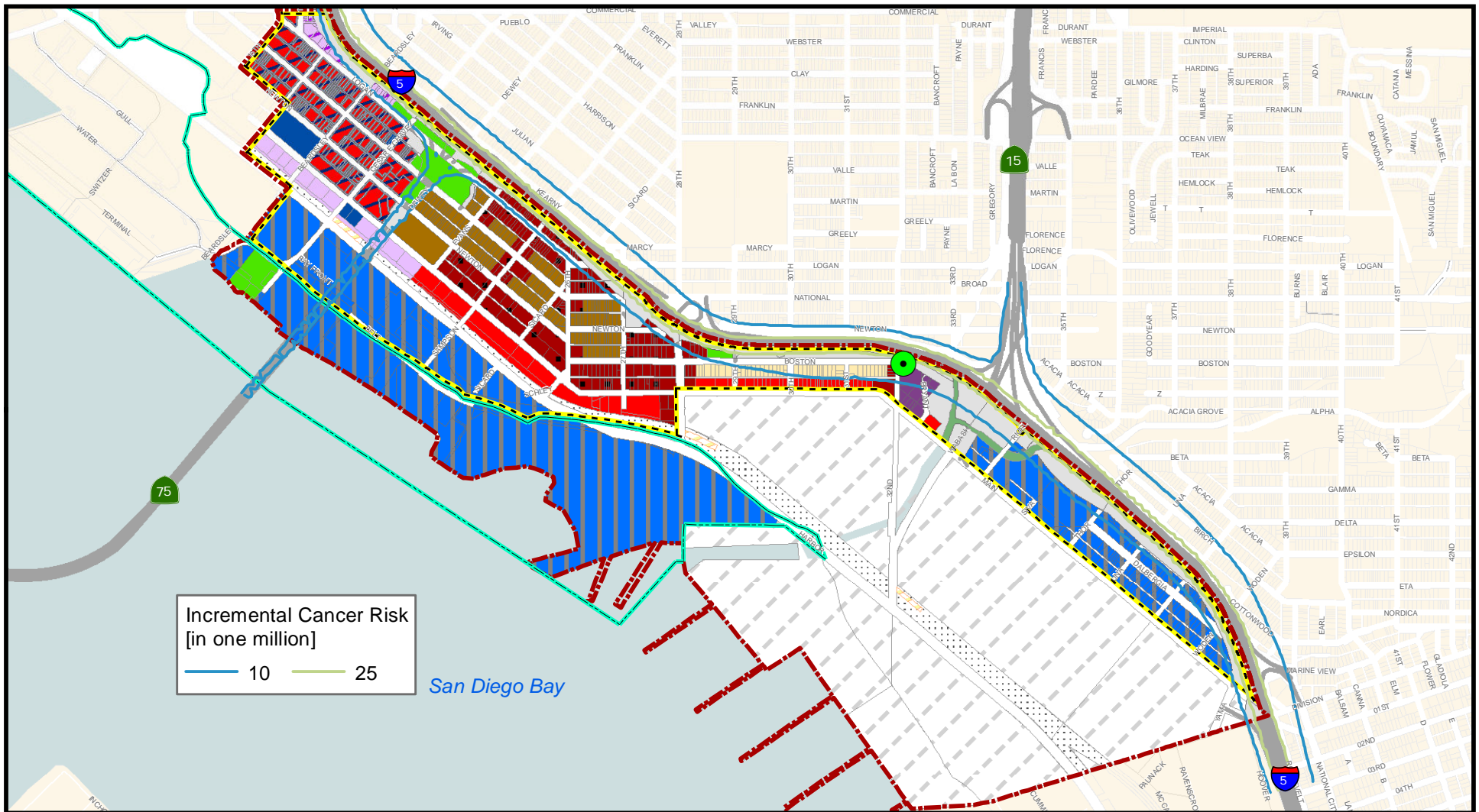

FIGURE 25
 Diesel Particulate Worker Incremental
 Cancer Risk Contours due to Freeway Traffic
 Overlain on the Adopted Community Plan Land Uses



Incremental Cancer Risk
[in one million]

— 10 — 25

San Diego Bay

- Barrio Logan Community Plan Area
- City of San Diego Jurisdictional Lands
- San Diego Unified Port District Limits
- MEIW

- Community Plan Land Use Alternative 1**
- Community Commercial
 - Community Village
 - Neighborhood Commercial (Residential Permitted)
 - Neighborhood Commercial (Residential Prohibited)
 - Heavy Commercial
 - Office Commercial (3 stories)

- Office Commercial (4-5 stories)
- Prime Industrial
- Residential Low
- Residential Medium
- Live/Work (4-5 stories)
- School/Institutional
- Open Space
- Park
- Military Use
- Transit Center
- Railroad Right of Way
- Caltrans Right of Way

0 Feet 1,500

FIGURE 26
 Diesel Particulate Worker Incremental
 Cancer Risk Contours due to Freeway Traffic
 Overlain on the Alternative 1 Community Plan Land Uses

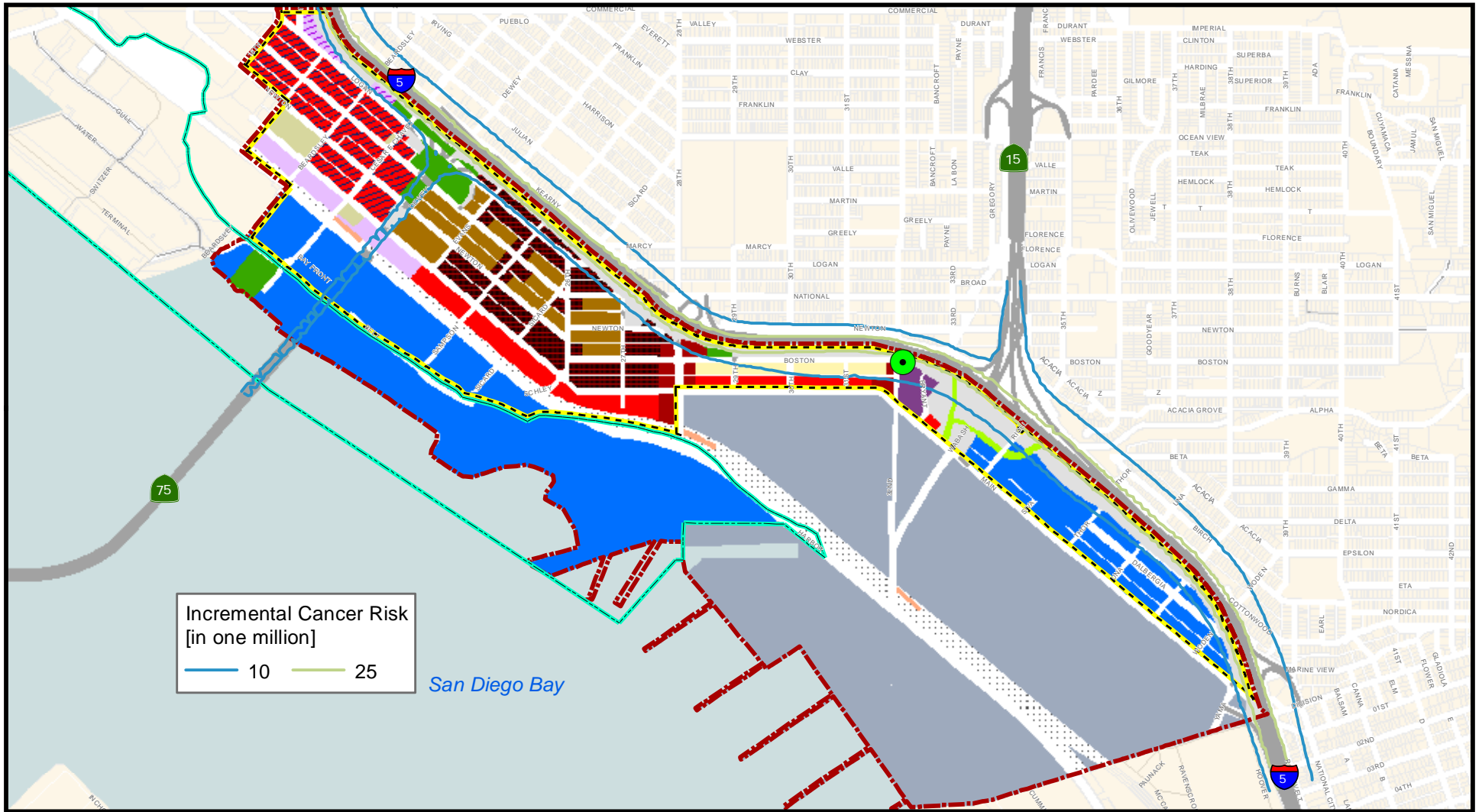

Incremental Cancer Risk
[in one million]

— 10 — 25

San Diego Bay

- | | | | |
|--|--|-------------------------------------|-----------------------|
| Barrio Logan Community Plan Area | Community Plan Land Use Alternative 1 | Office Commercial (Transition Zone) | Open Space |
| City of San Diego Jurisdictional Lands | Community Commercial | Office Commercial | Park |
| San Diego Unified Port District Limits | Community Village | Heavy Industrial | Military Use |
| MEIW | Neighborhood Commercial (Residential Permitted) | Residential Low | Transit Center |
| | Neighborhood Commercial (Residential Prohibited) | Residential Medium | Railroad Right of Way |
| | Heavy Commercial | School/Institutional | Caltrans Right of Way |

0 Feet 1,500

FIGURE 26

Diesel Particulate Worker Incremental Cancer Risk Contours due to Freeway Traffic Overlain on the Alternative 1 Community Plan Land Uses

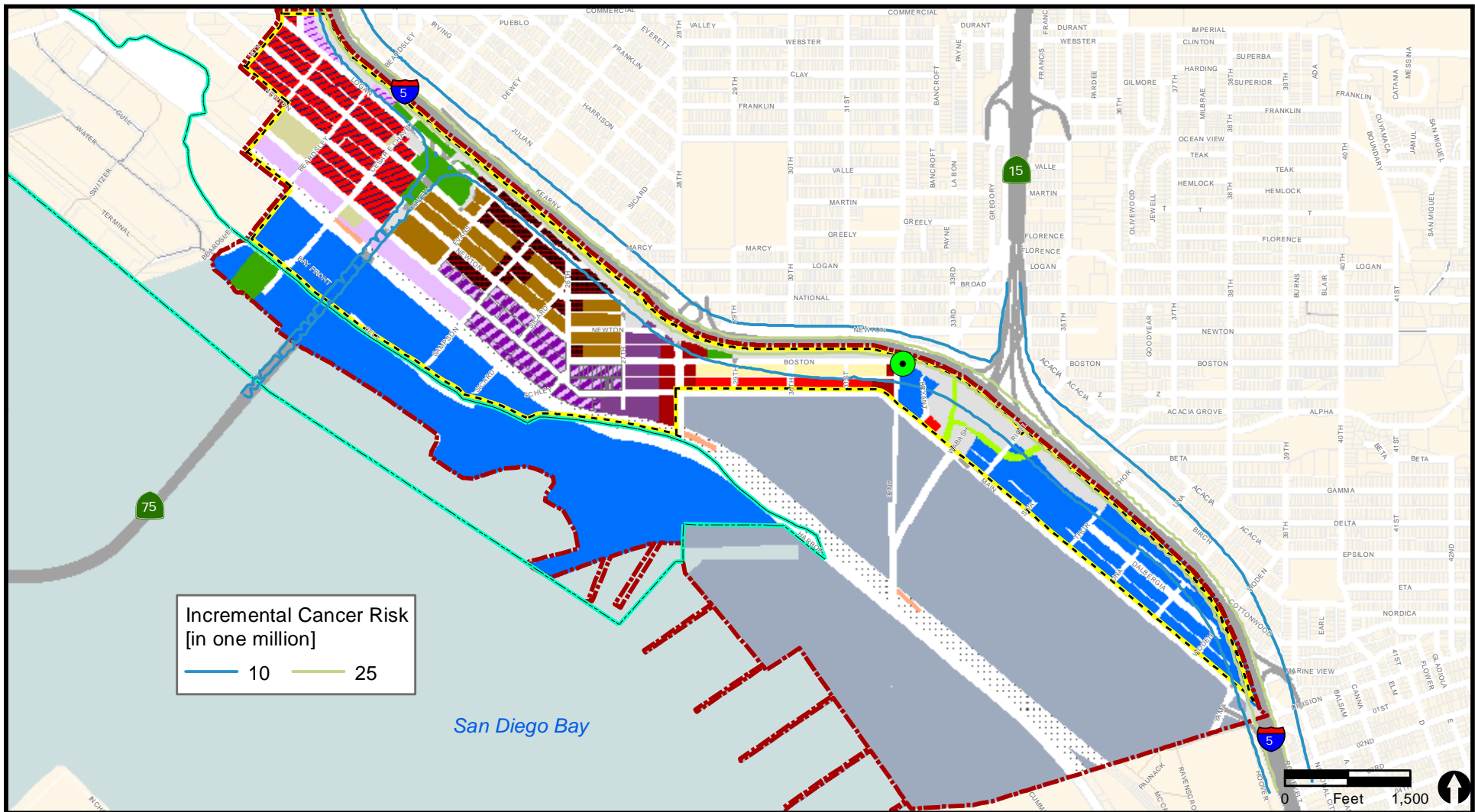

Incremental Cancer Risk
[in one million]





— 10 — 25

- | | | | | |
|--|---|--|----------------------|-----------------------|
| Barrio Logan Community Plan Area | Community Plan Land Use Alternative 2 | Neighborhood Commercial (Residential Prohibited) | Heavy Industrial | Park |
| City of San Diego Jurisdictional Lands | Community Commercial | Heavy Commercial | Residential Low | Military Use |
| San Diego Unified Port District Limits | Community Village | Maritime Oriented Commercial | Residential Medium | Transit Center |
| MEIW | Neighborhood Commercial (Residential Permitted) | Office Commercial (Transition Zone) | School/Institutional | Railroad Right of Way |
| | | Office Commercial | Open Space | Caltrans Right of Way |

FIGURE 27

Diesel Particulate Worker Incremental Cancer Risk Contours due to Freeway Traffic Overlain on the Revised Alternative 2 Community Plan Land Uses



-  Barrio Logan Community Plan Area
-  City of San Diego Jurisdictional Lands
-  San Diego Unified Port District Limits
-  Modeled Truck Route Segments
-  Modeled Receivers

0 Feet 1,500 

FIGURE 28
Modeled Truck Route Receivers
and Truck Route Segments

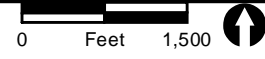
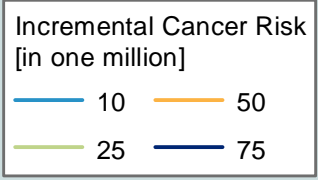
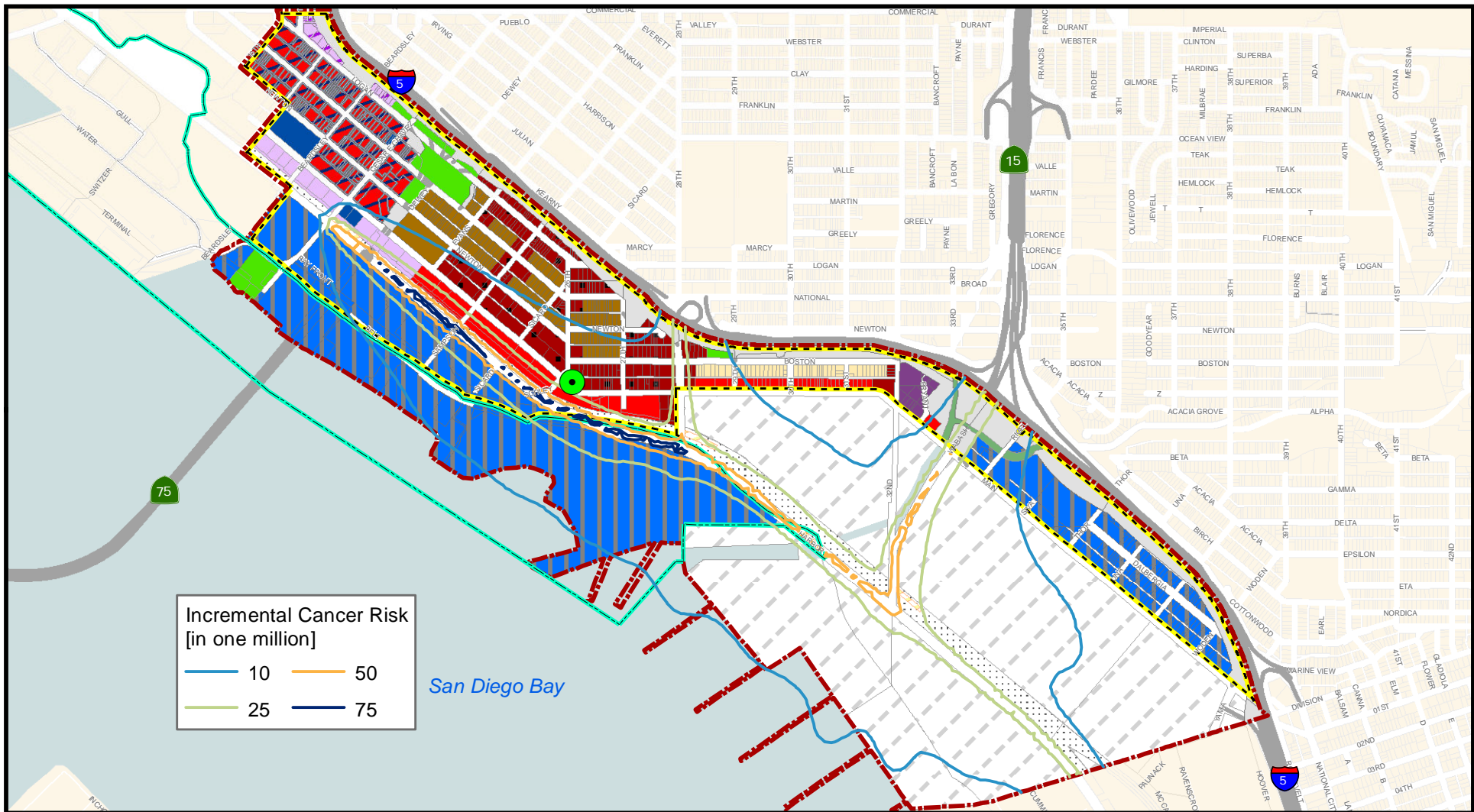
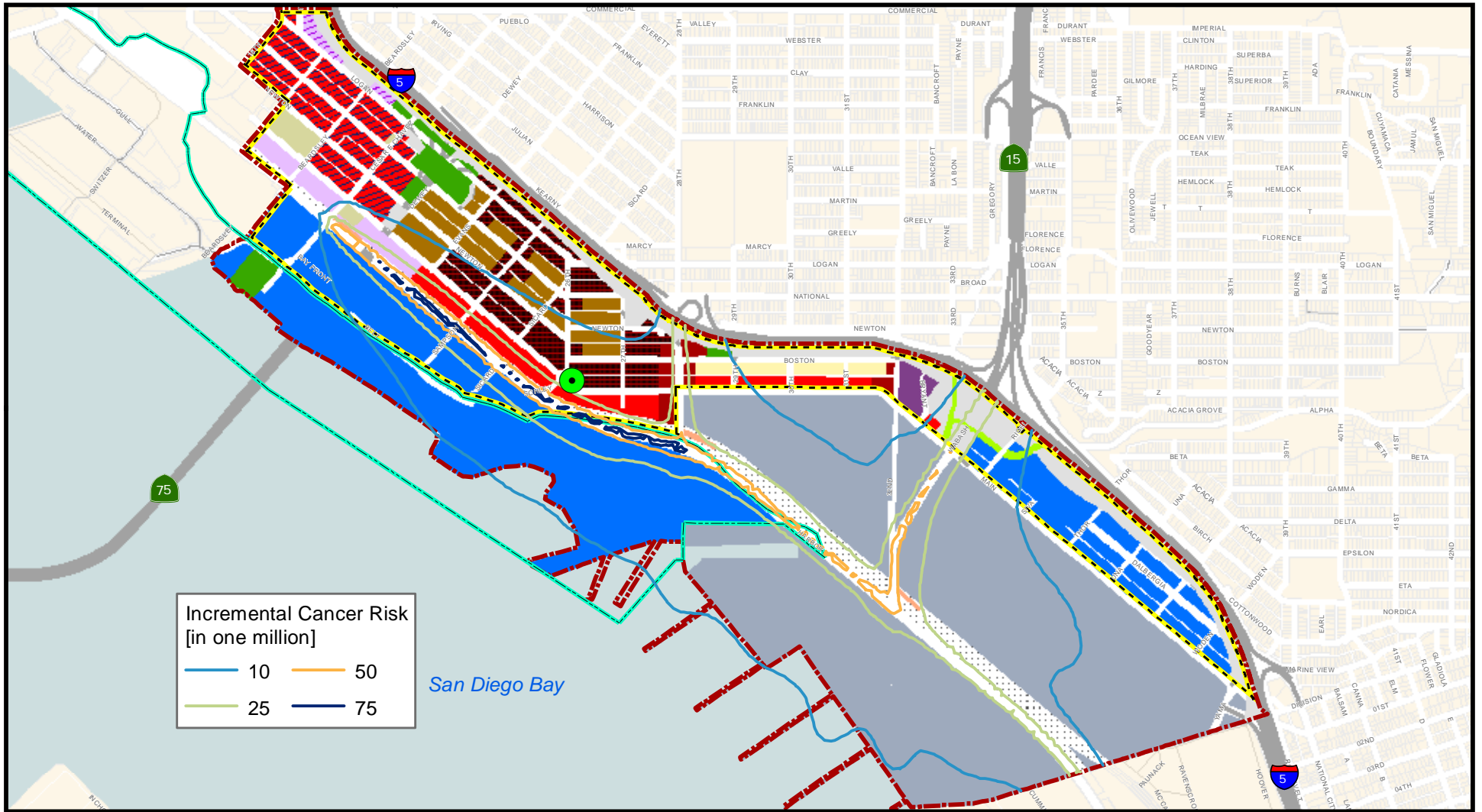

FIGURE 29
 Diesel Particulate 80th Percentile Residential Incremental Cancer Risk Contours due to Truck Route Traffic Overlain on the Alternative 1 Community Plan Land Uses



Incremental Cancer Risk
[in one million]

— 10	— 50
— 25	— 75

San Diego Bay

- | | | | |
|--|--|-------------------------------------|-----------------------|
| Barrio Logan Community Plan Area | Community Plan Land Use Alternative 1 | Office Commercial (Transition Zone) | Open Space |
| City of San Diego Jurisdictional Lands | Community Commercial | Office Commercial | Park |
| San Diego Unified Port District Limits | Community Village | Heavy Industrial | Military Use |
| MEIR | Neighborhood Commercial (Residential Permitted) | Residential Low | Transit Center |
| | Neighborhood Commercial (Residential Prohibited) | Residential Medium | Railroad Right of Way |
| | Heavy Commercial | School/Institutional | Caltrans Right of Way |

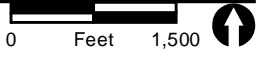
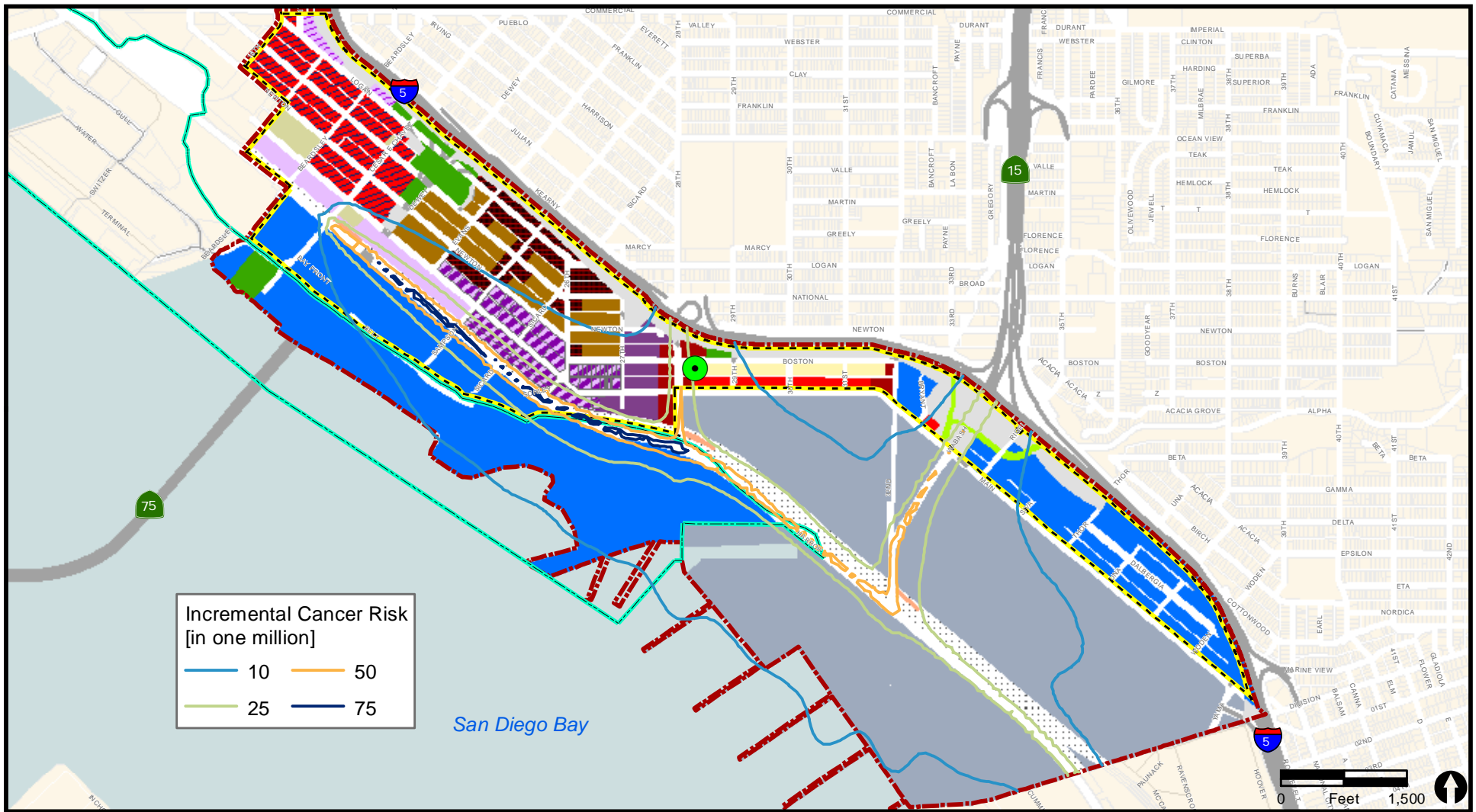

FIGURE 29

Diesel Particulate 80th Percentile Residential Incremental Cancer Risk Contours due to Truck Route Traffic Overlain on the Alternative 1 Community Plan Land Uses



- | | | | | |
|--|---|--|----------------------|-----------------------|
| Barrio Logan Community Plan | Community Plan Land Use Alternative | Neighborhood Commercial (Residential Prohibited) | Heavy Industrial | Park |
| City of San Diego Jurisdictional Lands | Community Commercial | Heavy Commercial | Residential Low | Military Use |
| San Diego Unified Port District Limits | Community Village | Maritime Oriented Commercial | Residential Medium | Transit Center |
| MEIR | Neighborhood Commercial (Residential Permitted) | Office Commercial (Transition Zone) | School/Institutional | Railroad Right of Way |
| | Office Commercial | Office Commercial | Open Space | Caltrans Right of Way |

FIGURE 30

Diesel Particulate 80th Percentile Residential Incremental Cancer Risk Contours due to Truck Route Traffic Overlain on the Revised Alternative 2 Community Plan Land Uses

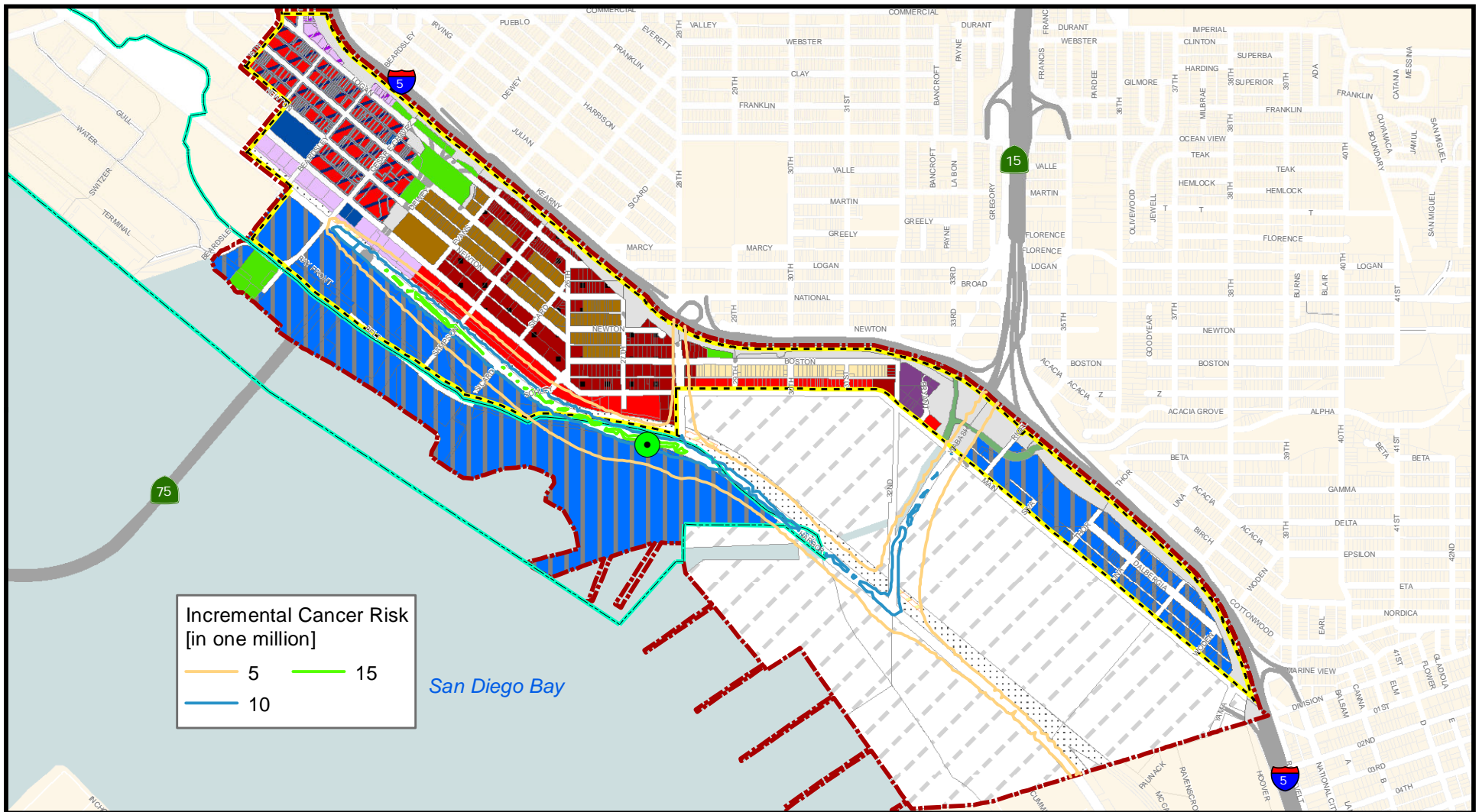

**Incremental Cancer Risk
[in one million]**

— 5 — 15
— 10

San Diego Bay

- | | | |
|---|--|--|
| <ul style="list-style-type: none"> Barrio Logan Community Plan Area City of San Diego Jurisdictional Lands San Diego Unified Port District Limits ● MEIW | <p>Community Plan Land Use Alternative 1</p> <ul style="list-style-type: none"> Community Commercial Community Village Neighborhood Commercial (Residential Permitted) Neighborhood Commercial (Residential Prohibited) Heavy Commercial Office Commercial (3 stories) | <ul style="list-style-type: none"> Office Commercial (4-5 stories) Prime Industrial Residential Low Residential Medium Live/Work (4-5 stories) School/Institutional Open Space Park Military Use Transit Center Railroad Right of Way Caltrans Right of Way |
|---|--|--|

0 Feet 1,500

FIGURE 31
 Diesel Particulate Worker Incremental
 Cancer Risk Contours due to Truck Route Traffic
 Overlain on the Alternative 1 Community Plan Land Uses

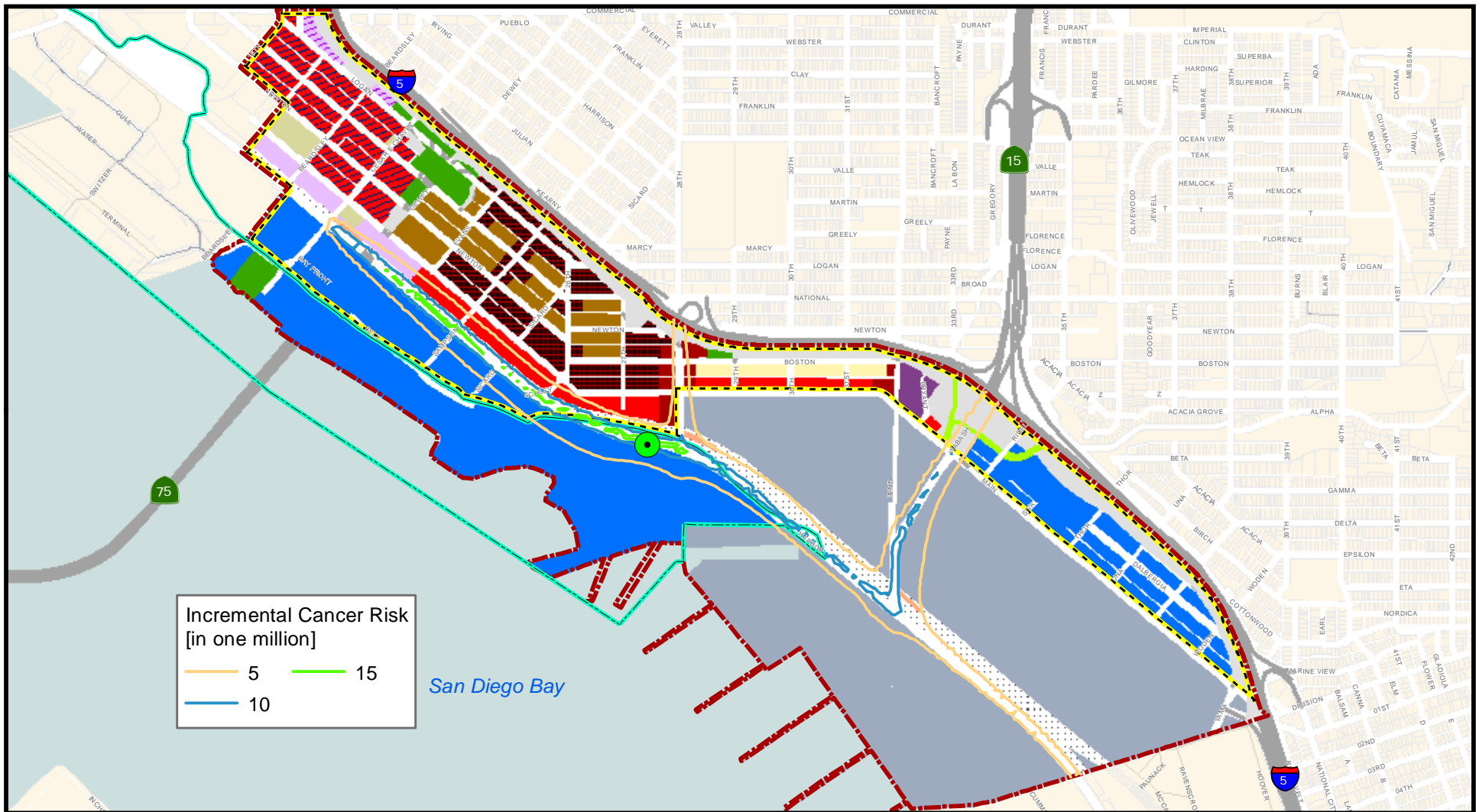

**Incremental Cancer Risk
[in one million]**

— 5 — 15
— 10

- | | | |
|--|---|---|
| <ul style="list-style-type: none"> Barrio Logan Community Plan Area City of San Diego Jurisdictional Lands San Diego Unified Port District Limits ● MEIW | <p>Community Plan Land Use Alternative 1</p> <ul style="list-style-type: none"> Community Commercial Community Village Neighborhood Commercial (Residential Permitted) Neighborhood Commercial (Residential Prohibited) Heavy Commercial | <ul style="list-style-type: none"> Office Commercial (Transition Zone) Office Commercial Heavy Industrial Residential Low Residential Medium School/Institutional Open Space Park Military Use Transit Center Railroad Right of Way Caltrans Right of Way |
|--|---|---|

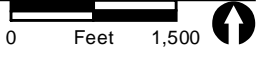
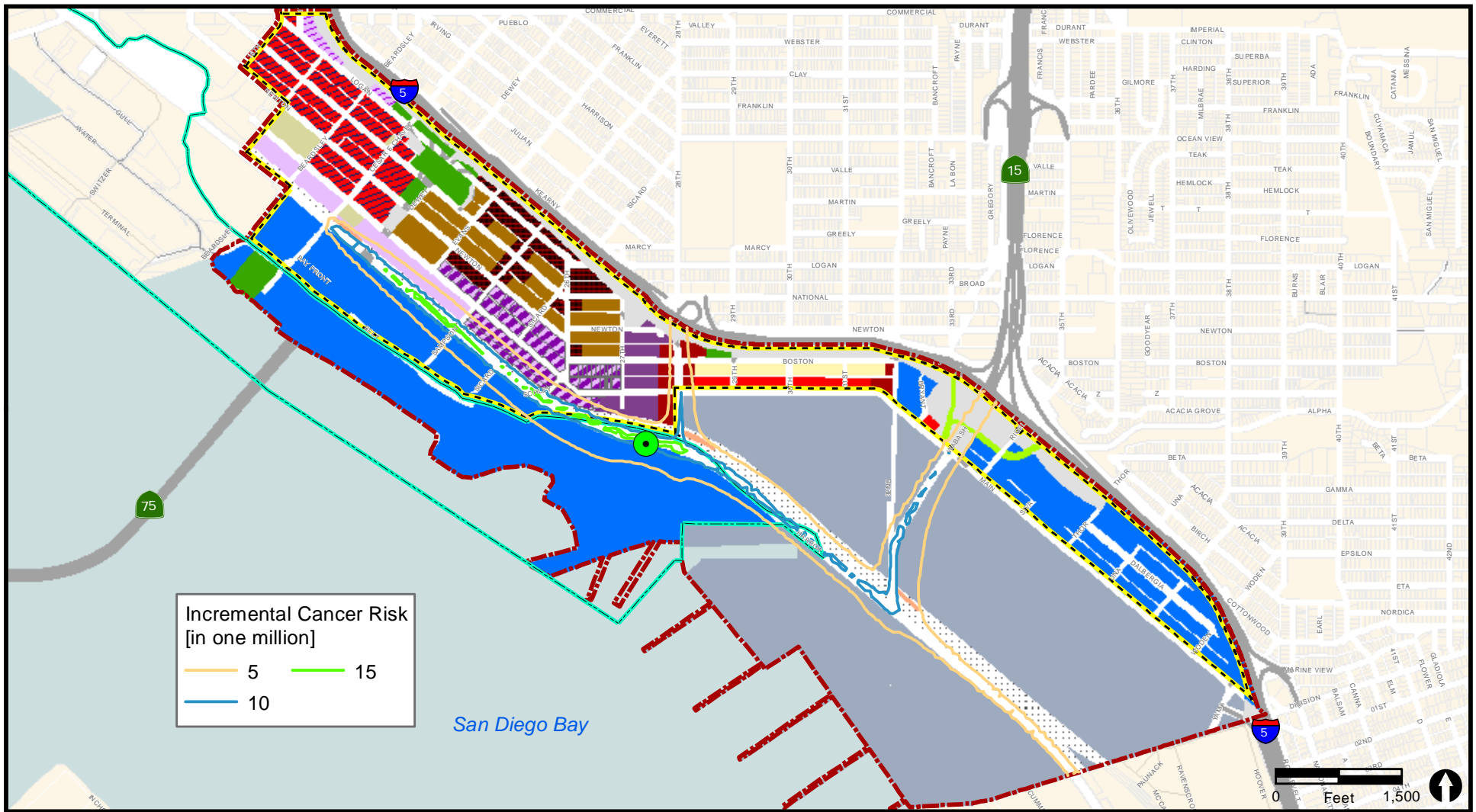

FIGURE 31
 Diesel Particulate Worker Incremental
 Cancer Risk Contours due to Truck Route Traffic
 Overlain on the Alternative 1 Community Plan Land Uses



Incremental Cancer Risk
[in one million]

— 5 — 15
— 10

- | | | | | |
|--|---|--|----------------------|-----------------------|
| Barrio Logan Community Plan | Community Plan Land Use Alternative 2 | Neighborhood Commercial (Residential Prohibited) | Heavy Industrial | Park |
| City of San Diego Jurisdictional Lands | Community Commercial | Heavy Commercial | Residential Low | Military Use |
| San Diego Unified Port District Limits | Community Village | Maritime Oriented Commercial | Residential Medium | Transit Center |
| MEIW | Neighborhood Commercial (Residential Permitted) | Office Commercial (Transition Zone) | School/Institutional | Railroad Right of Way |
| | | Office Commercial | Open Space | Caltrans Right of Way |

FIGURE 32
Diesel Particulate Worker Incremental Cancer Risk Contours due to Truck Route Traffic Overlain on the Revised Alternative 2 Community Plan Land Uses

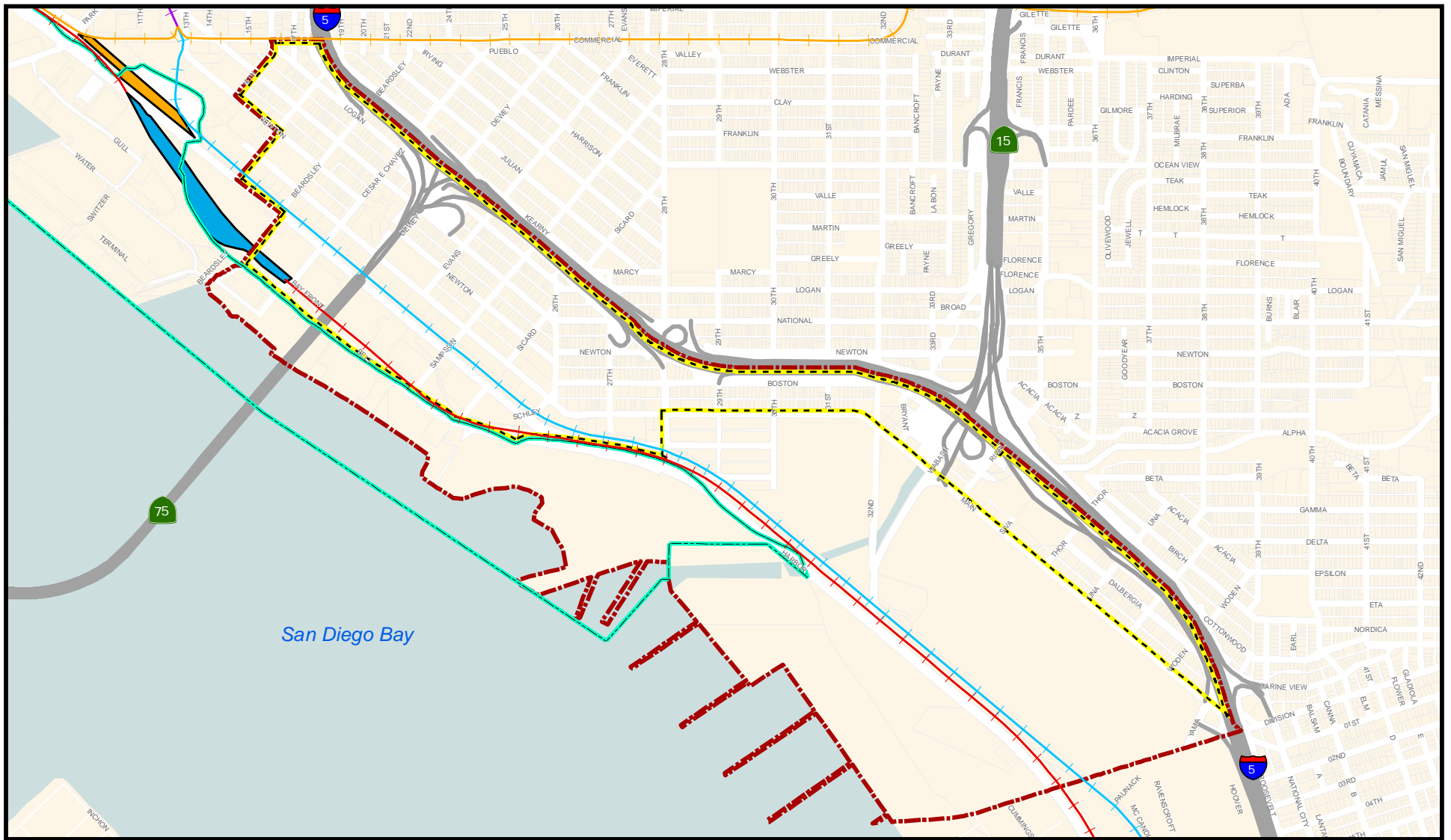

- Barrio Logan Community Plan Area
- City of San Diego Jurisdictional Lands
- San Diego Unified Port District Limits
- SDIY Yard
- BNSF Yard
- BNSF Main Line
- MTS Trolley Lines
- Blue
- Orange
- Blue/Orange

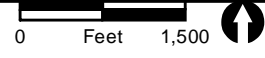
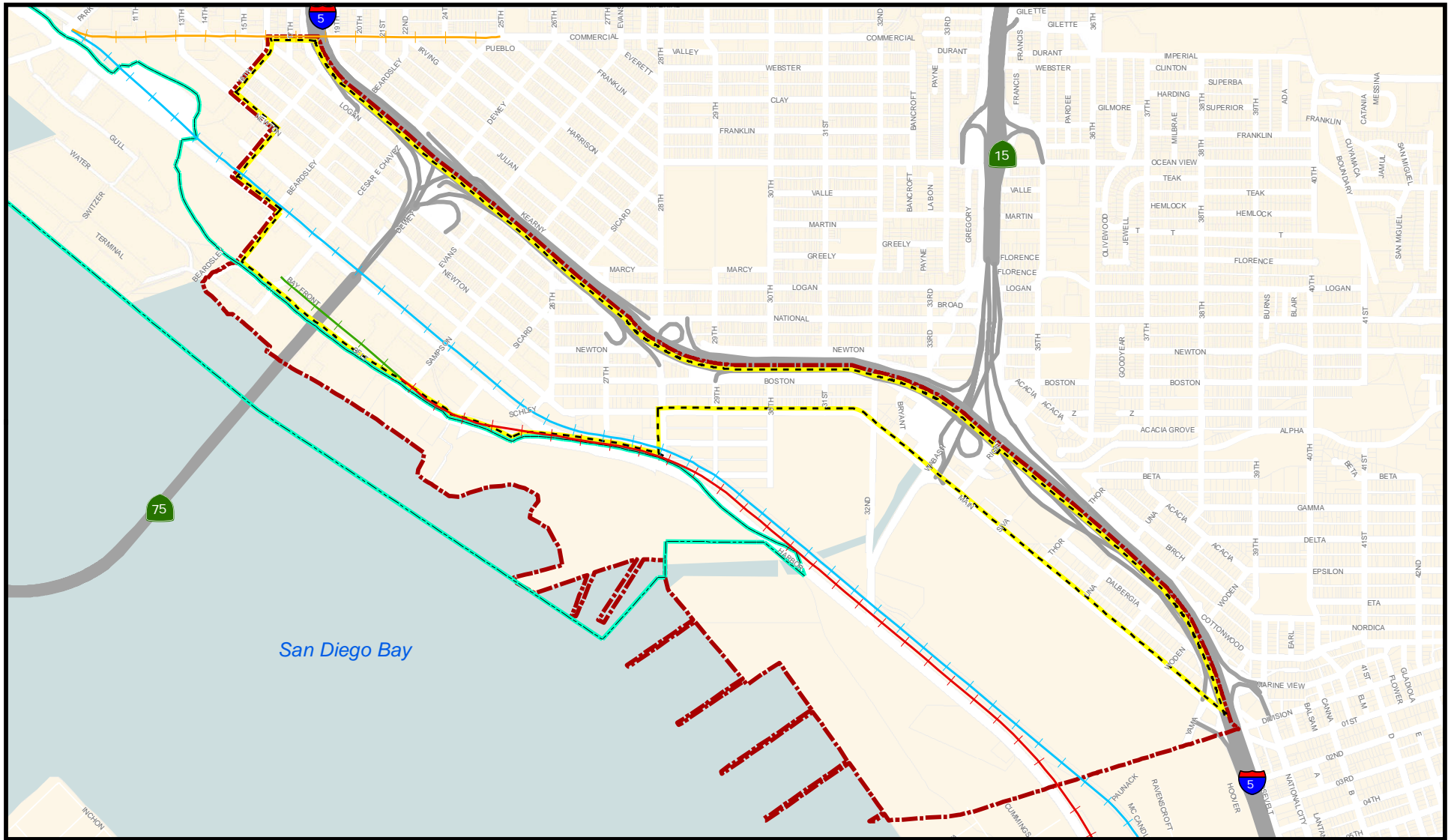

FIGURE 33
Locations of Rail Lines in Barrio Logan Area



- Barrio Logan Community Plan Area
- City of San Diego Jurisdictional Lands
- San Diego Unified Port District Limits
- SDIY El Cajon Line
- SDIY San Ysidro Line
- BNSF Single Track Mainline
- BNSF Double Track Mainline

0 Feet 1,500

FIGURE 34
Modeled Rail Lines

Image source: Aerials Express (flown February 2010)

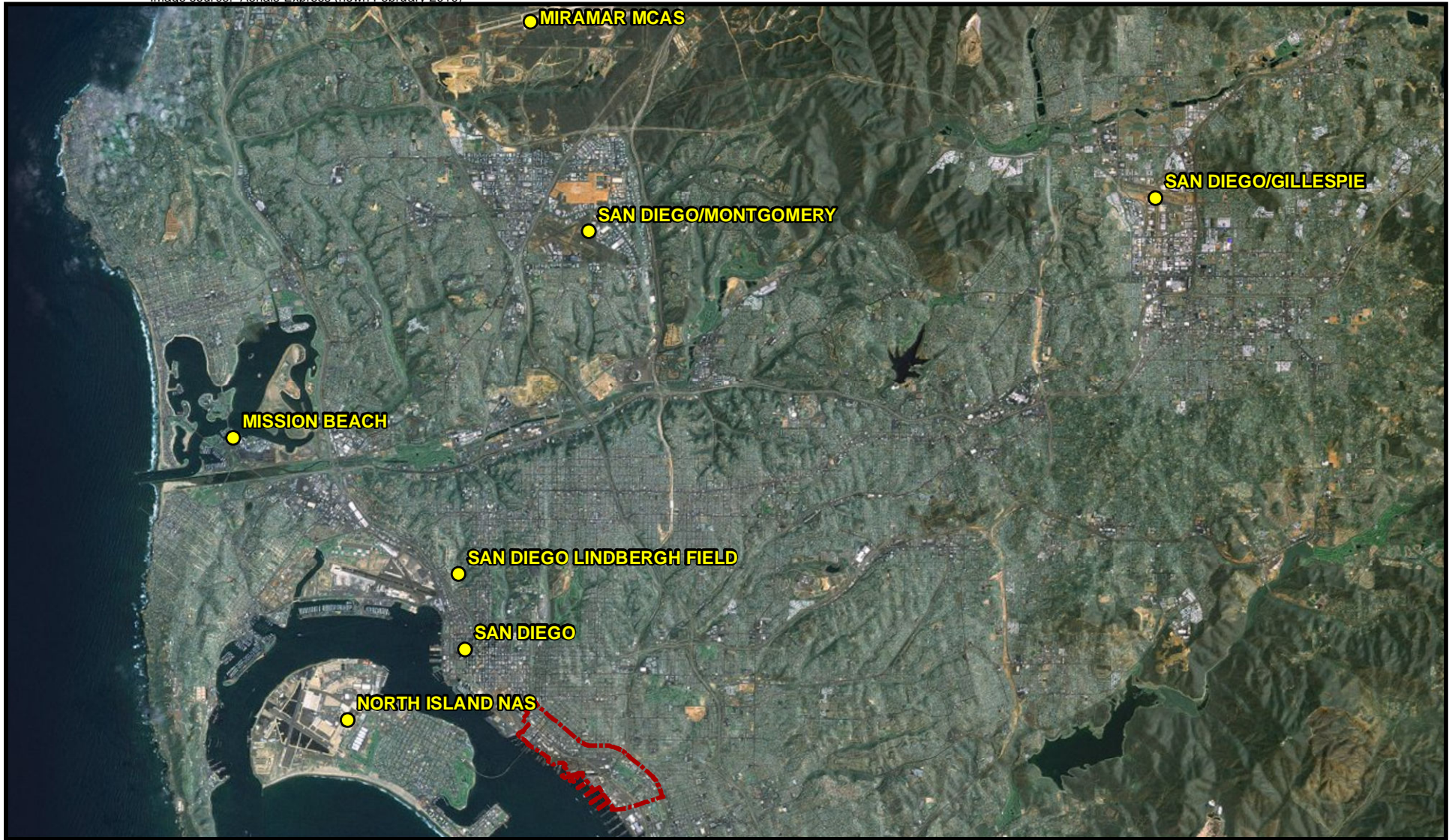









-  Barrio Logan Community Plan Area
-  Meteorological Monitoring Station

FIGURE 35
Meteorology Data Stations

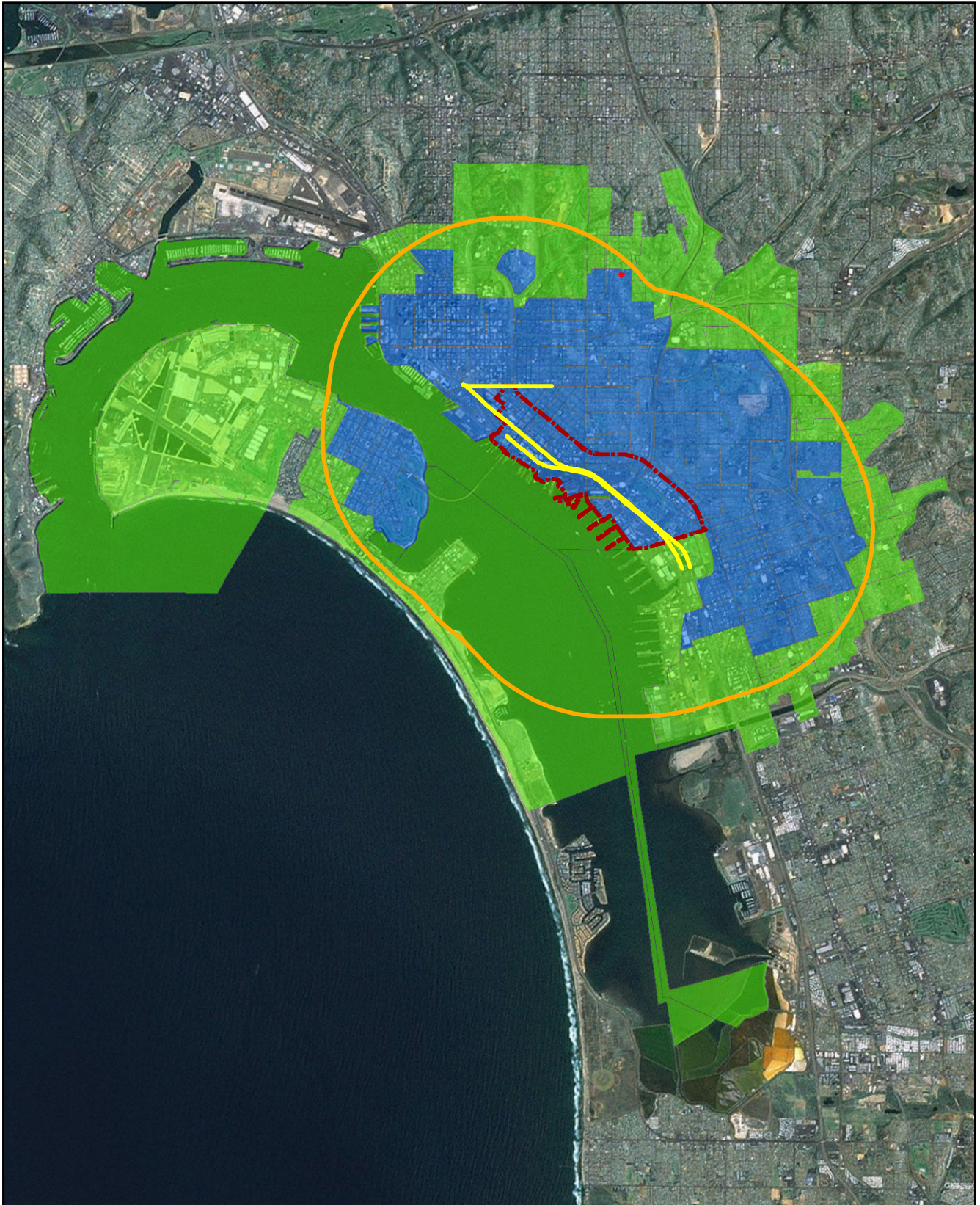

-  Barrio Logan Community Plan Area
-  Modeled Rail Lines
-  3 km Buffer Around Barrio Logan CPU Area

-  Census Blocks Included within 3 km Buffer
-  Census Block Entirely Contained within 3 km Buffer

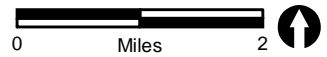
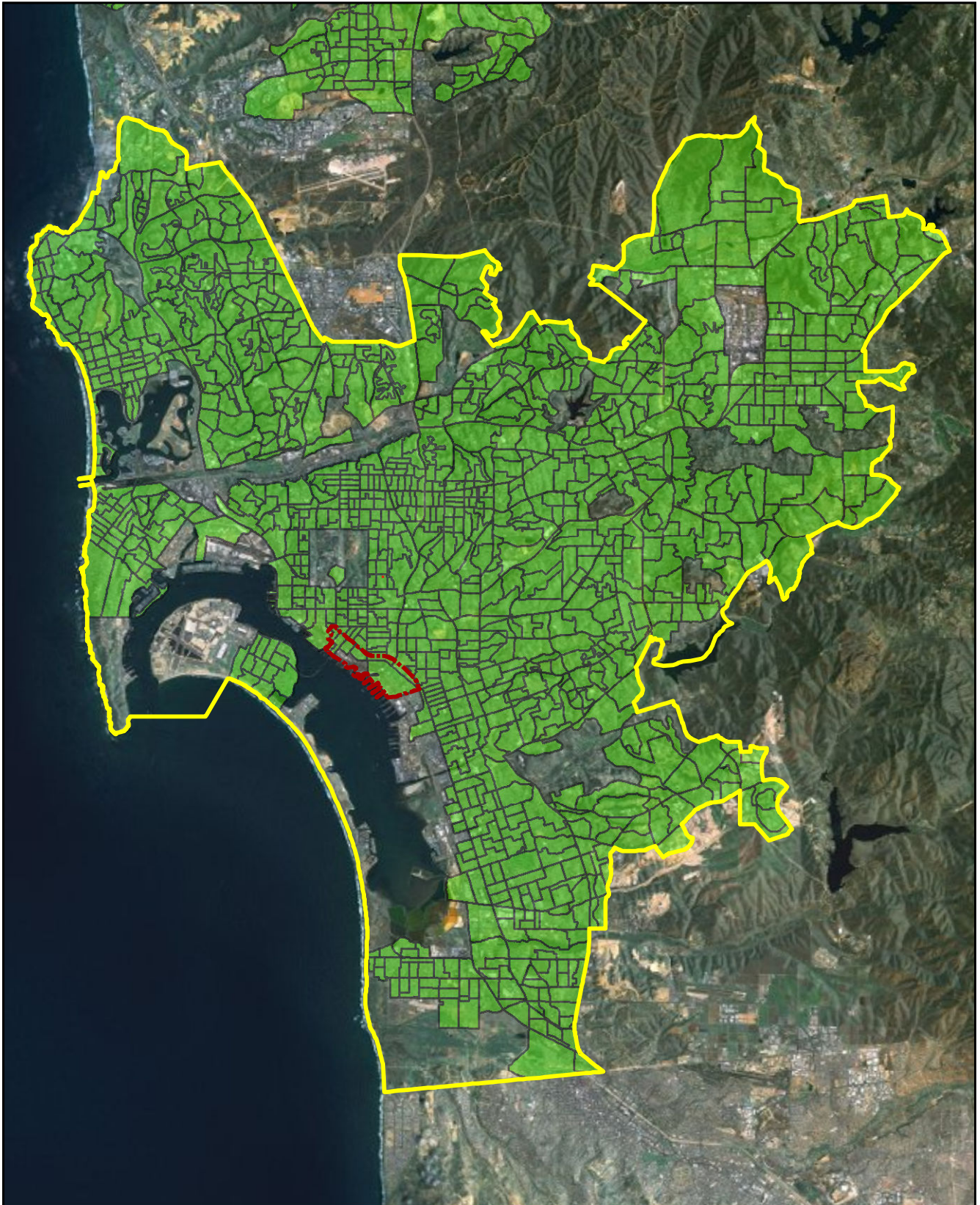





FIGURE 36

U.S. Census Bureau Census Blocks



-  Barrio Logan Community Plan Area
-  Parcels with a Population Density of at Least 750 People per Square Kilometer
-  Continuous Urban Area Assumed for Model

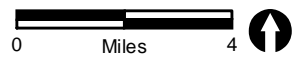

FIGURE 37
Urban Population

Image source: Aerials Express (flown February 2010)



- Volume Source Center Points
- +— BNSF Single Track Mainline
- +— BNSF Double Track Mainline
- Single Track Volume Source
- Double Track Volume Source

0 Feet 50

FIGURE 38
Example Volume Source Layout

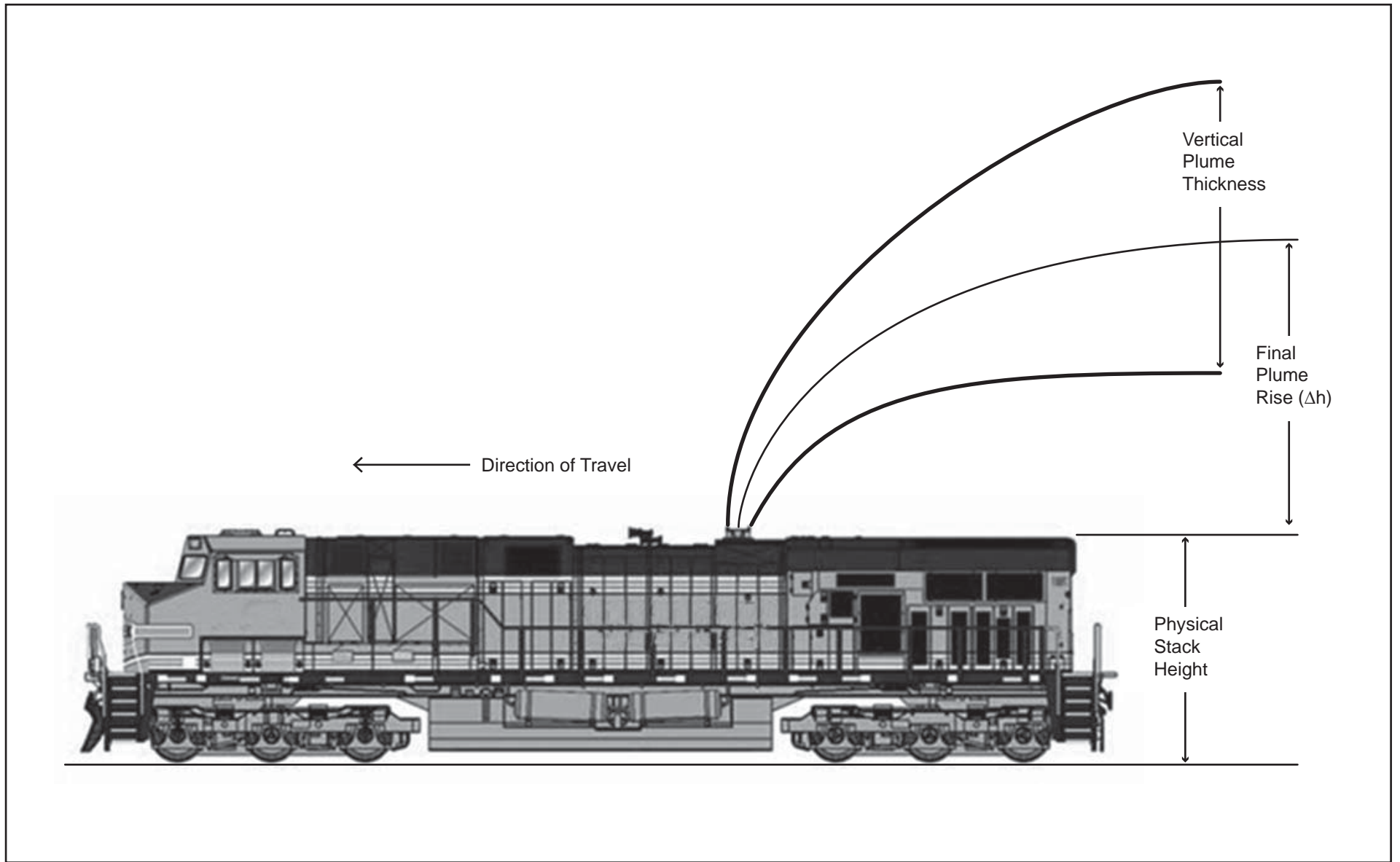

FIGURE 39

Locomotive Exhaust Plume Rise

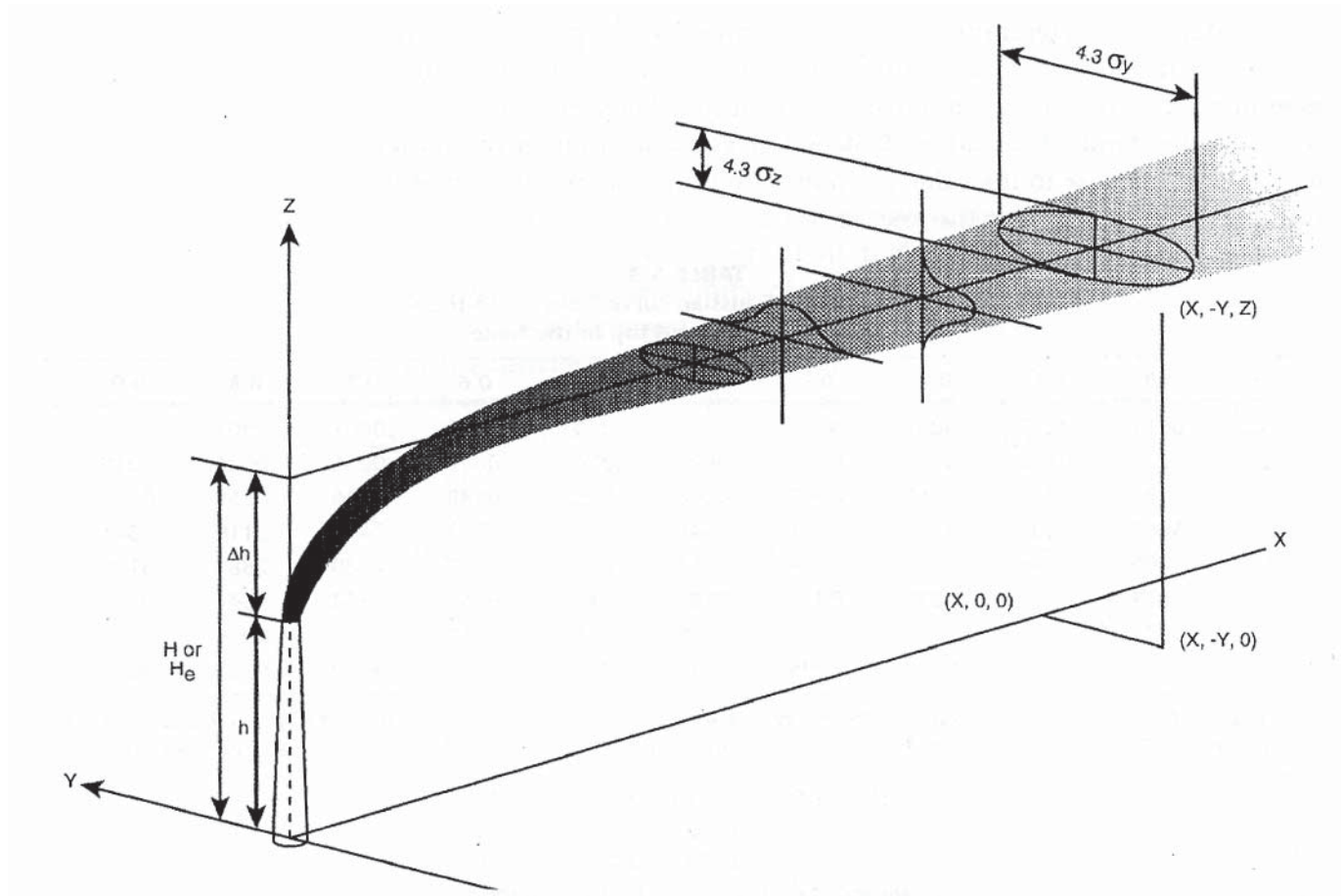
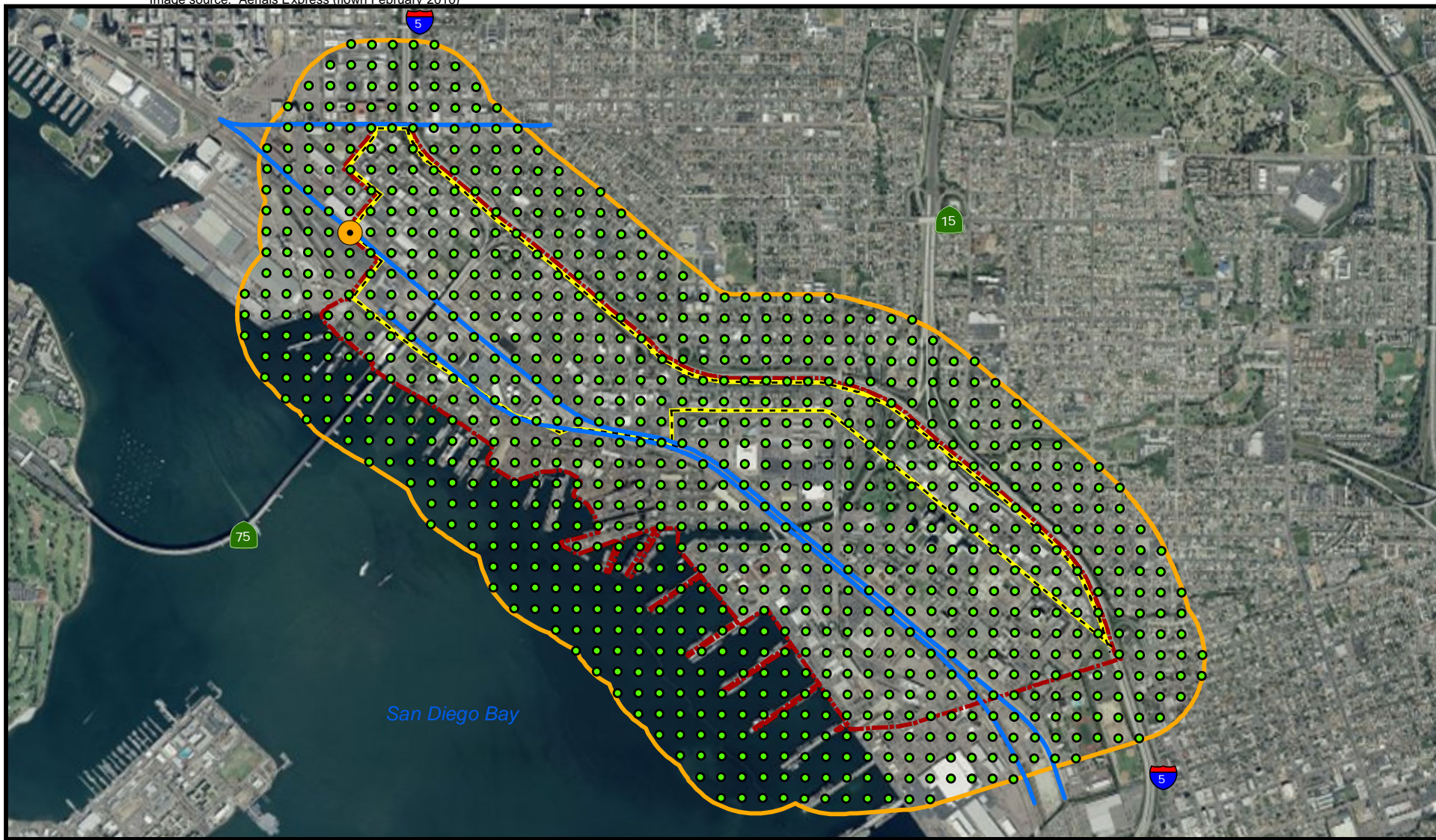

FIGURE 40

Coordinate System for Gaussian Modeling



- Barrio Logan Community Plan Area
- City of San Diego Jurisdictional Lands
- 1/4-mile Buffer Around Barrio Logan CPU Area
- Modeled Rail Lines
- Point of Maximum Impact
- Grid Receiver

0 Feet 2,000

FIGURE 41
Rail Line Grid Receivers

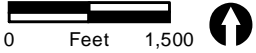
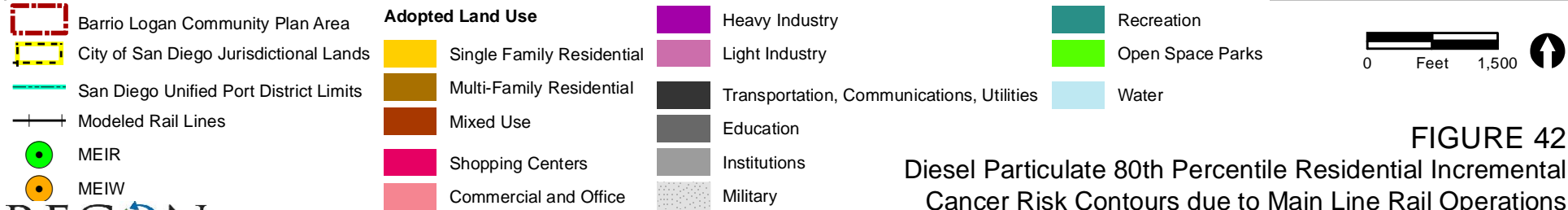
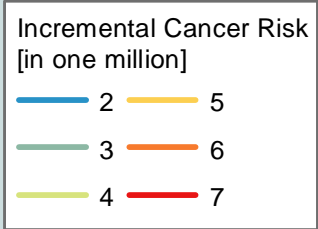
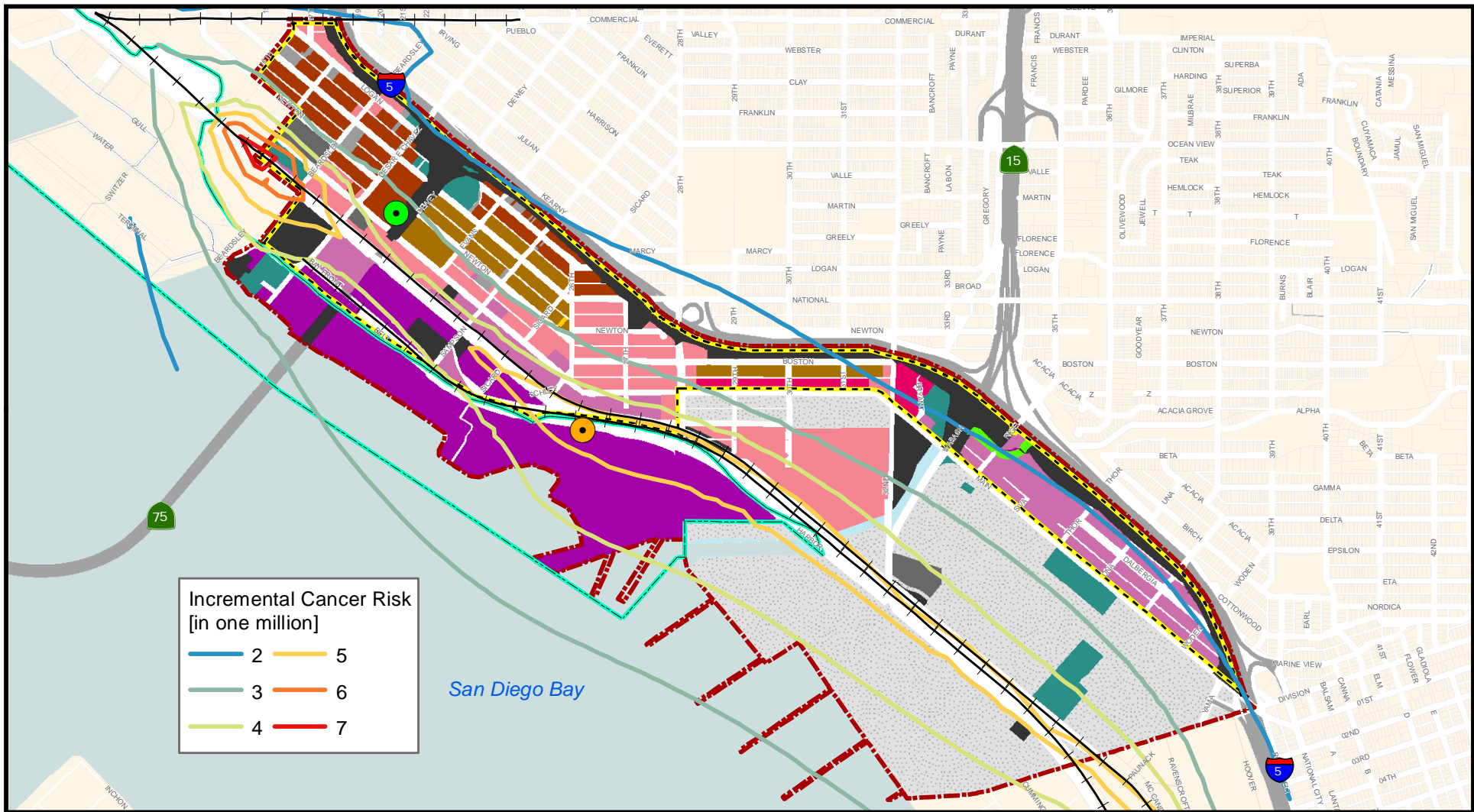
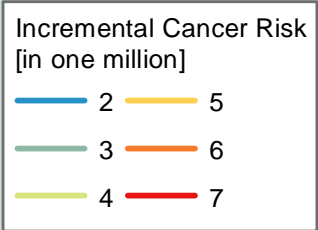
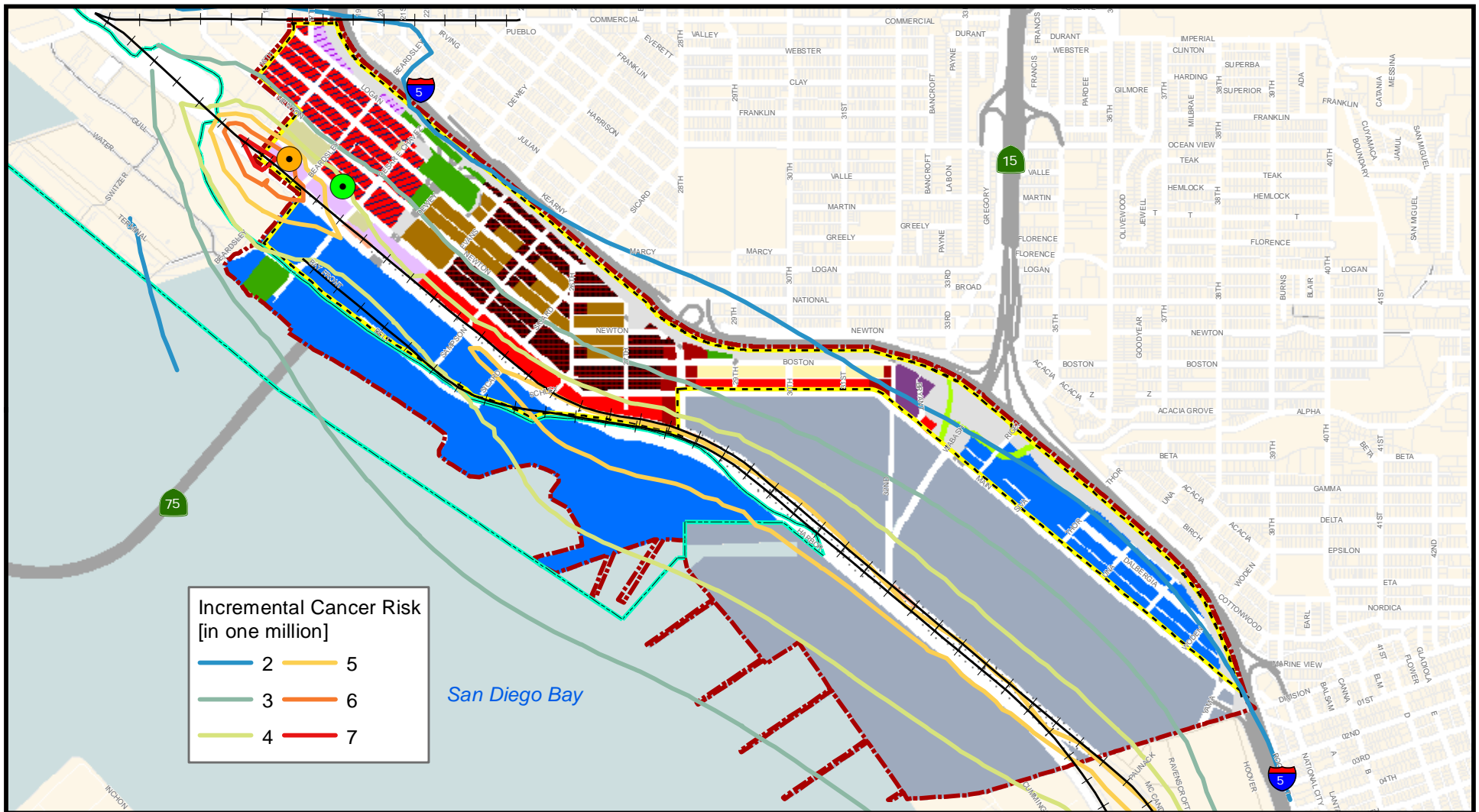

FIGURE 42
 Diesel Particulate 80th Percentile Residential Incremental
 Cancer Risk Contours due to Main Line Rail Operations
 Overlain on the Adopted Community Plan Land Uses



- | | | | |
|--|--|-------------------------------------|-----------------------|
| Barrio Logan Community Plan Area | Community Plan Land Use Alternative 1 | Office Commercial (Transition Zone) | Open Space |
| City of San Diego Jurisdictional Lands | Community Commercial | Office Commercial | Park |
| San Diego Unified Port District Limits | Community Village | Heavy Industrial | Military Use |
| Modeled Rail Lines | Neighborhood Commercial (Residential Permitted) | Residential Low | Transit Center |
| MEIR | Neighborhood Commercial (Residential Prohibited) | Residential Medium | Railroad Right of Way |
| MEIW | Heavy Commercial | School/Institutional | Caltrans Right of Way |

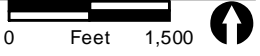
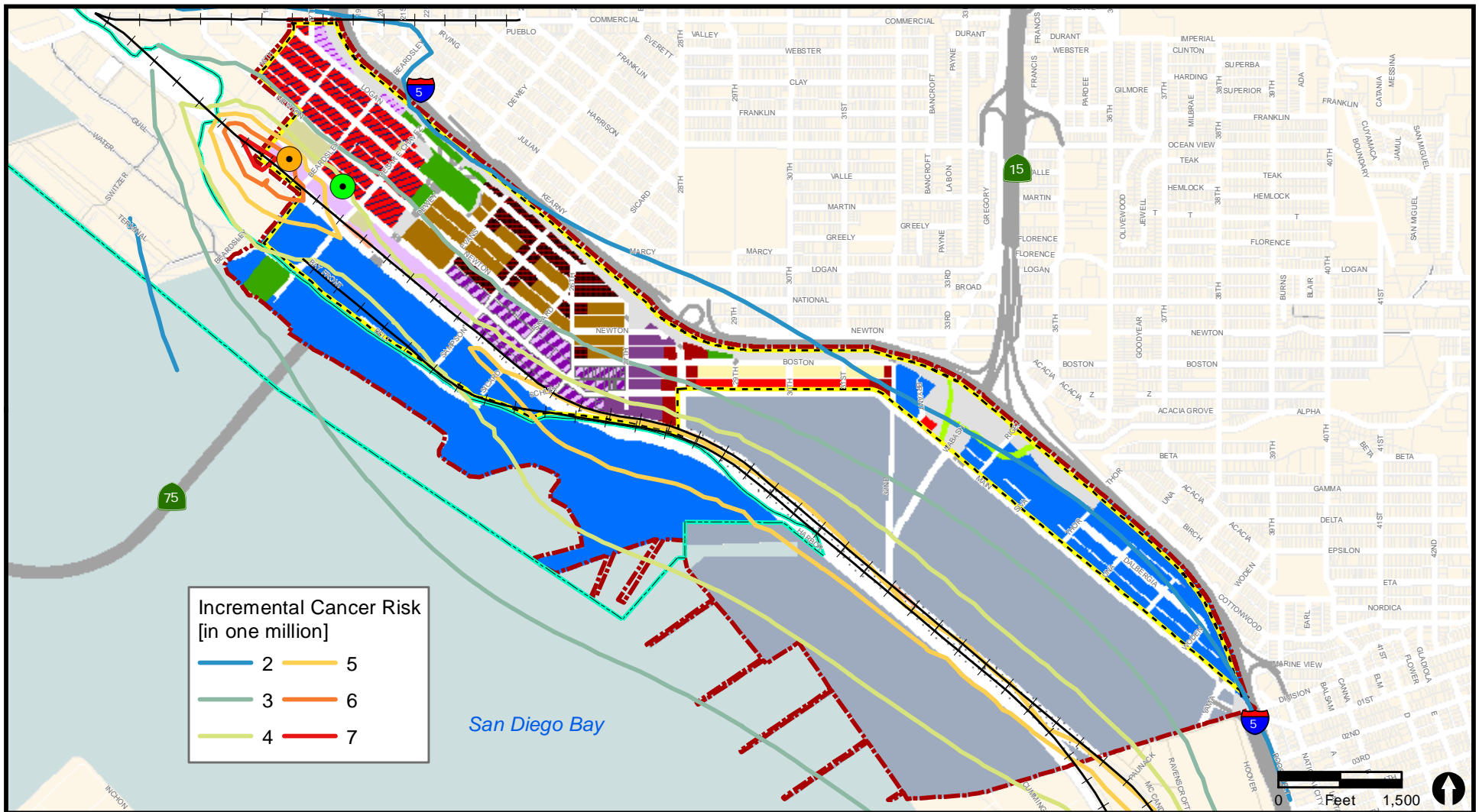

FIGURE 43
 Diesel Particulate 80th Percentile Residential Incremental Cancer Risk Contours due to Main Line Rail Operations Overlain on the Alternative 1 Community Plan Land Uses



**Incremental Cancer Risk
[in one million]**

Blue line	2	Yellow line	5
Green line	3	Orange line	6
Light Green line	4	Red line	7

- | | | | | |
|--|---|--|----------------------|-----------------------|
| Barrio Logan Community Plan Area | MEIW | Neighborhood Commercial (Residential Prohibited) | Heavy Industrial | Military Use |
| San Diego Unified Port District Limits | Community Plan Land Use Alternative 2 | Heavy Commercial | Residential Low | Transit Center |
| City of San Diego Jurisdictional Lands | Community Commercial | Maritime Oriented Commercial | Residential Medium | Railroad Right of Way |
| Modeled Rail Lines | Community Village | Office Commercial (Transition Zone) | School/Institutional | Caltrans Right of Way |
| MEIR | Neighborhood Commercial (Residential Permitted) | Office Commercial | Open Space | |
| | | Park | | |

FIGURE 44
 Diesel Particulate 80th Percentile Residential Incremental Cancer Risk Contours
 Due to Main Line Rail Operations Overlain on the Revised Alternative 2 Community Plan Land Uses

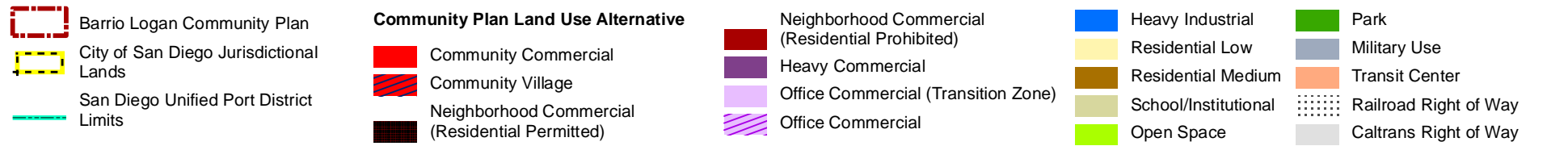
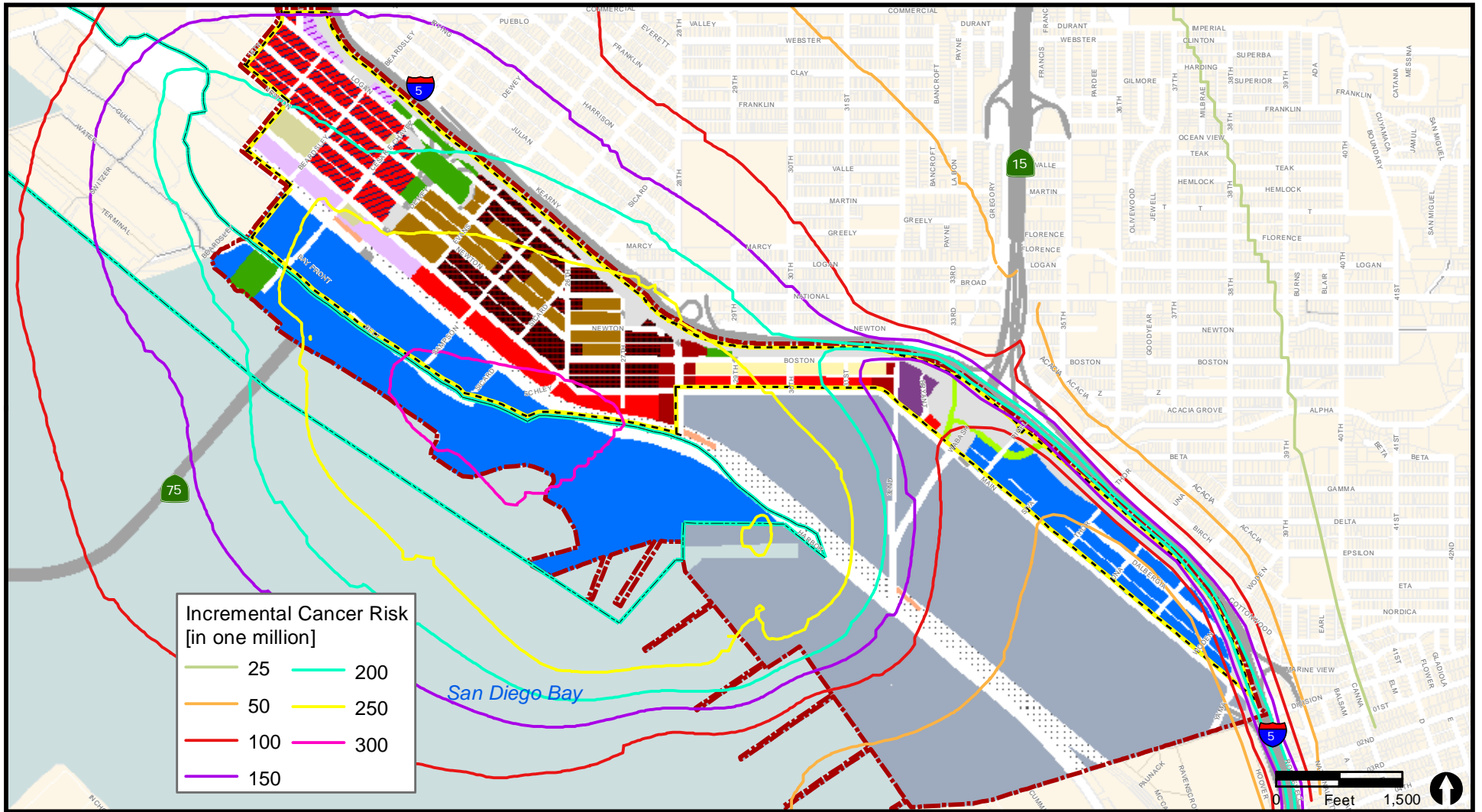

FIGURE 45

Total Estimated Diesel Particulate 80th Percentile Residential Incremental Cancer Risk Contours Overlain on the Alternative 1 Community Plan Land Uses

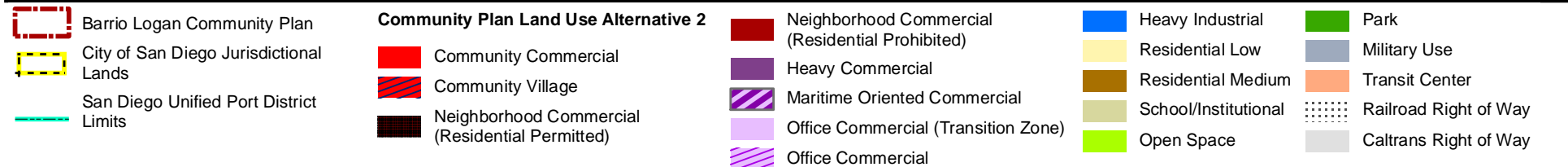
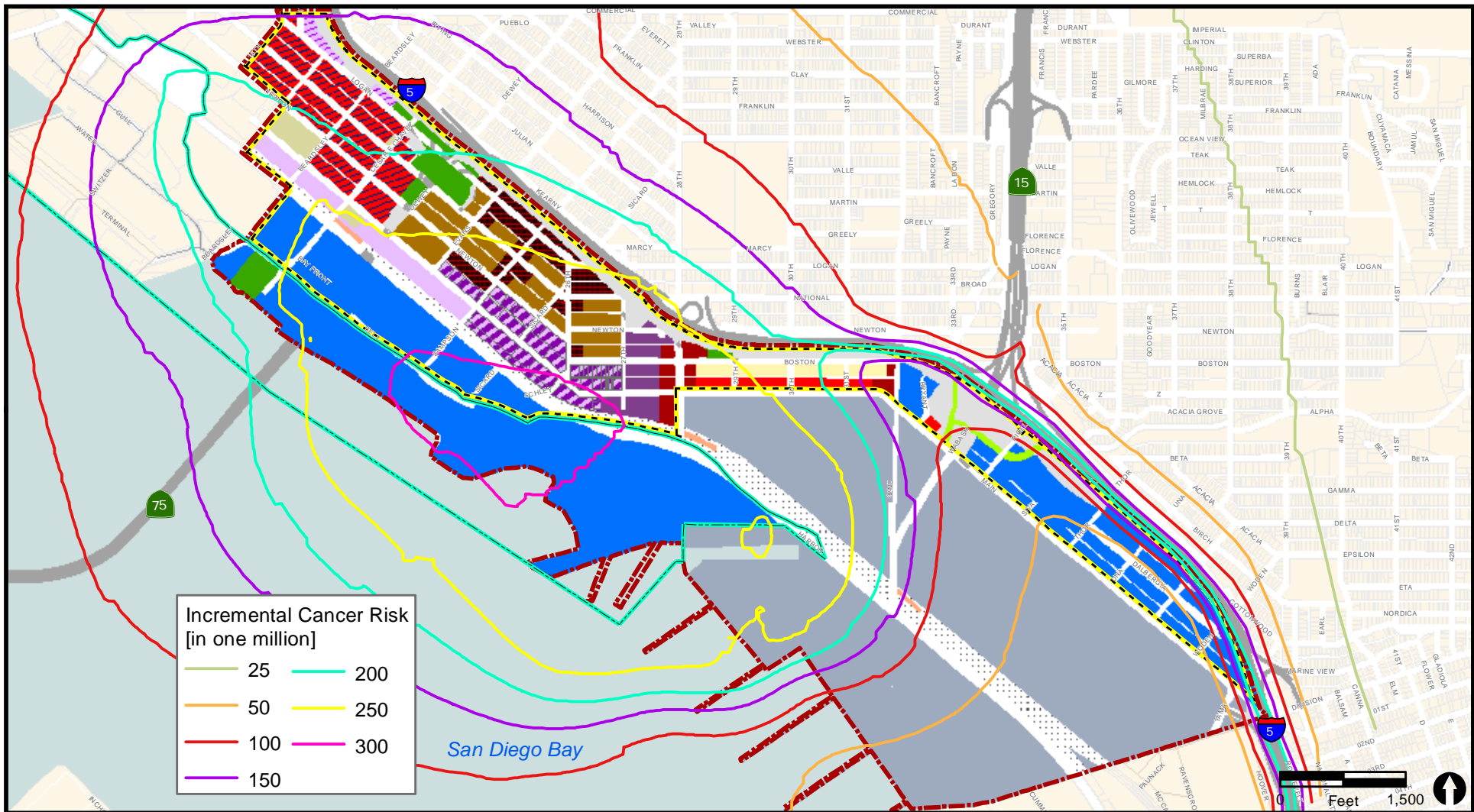

FIGURE 46

Total Estimated Diesel Particulate 80th Percentile Residential Incremental Cancer Risk Contours Overlain on the Revised Alternative 2 Community Plan Land Uses

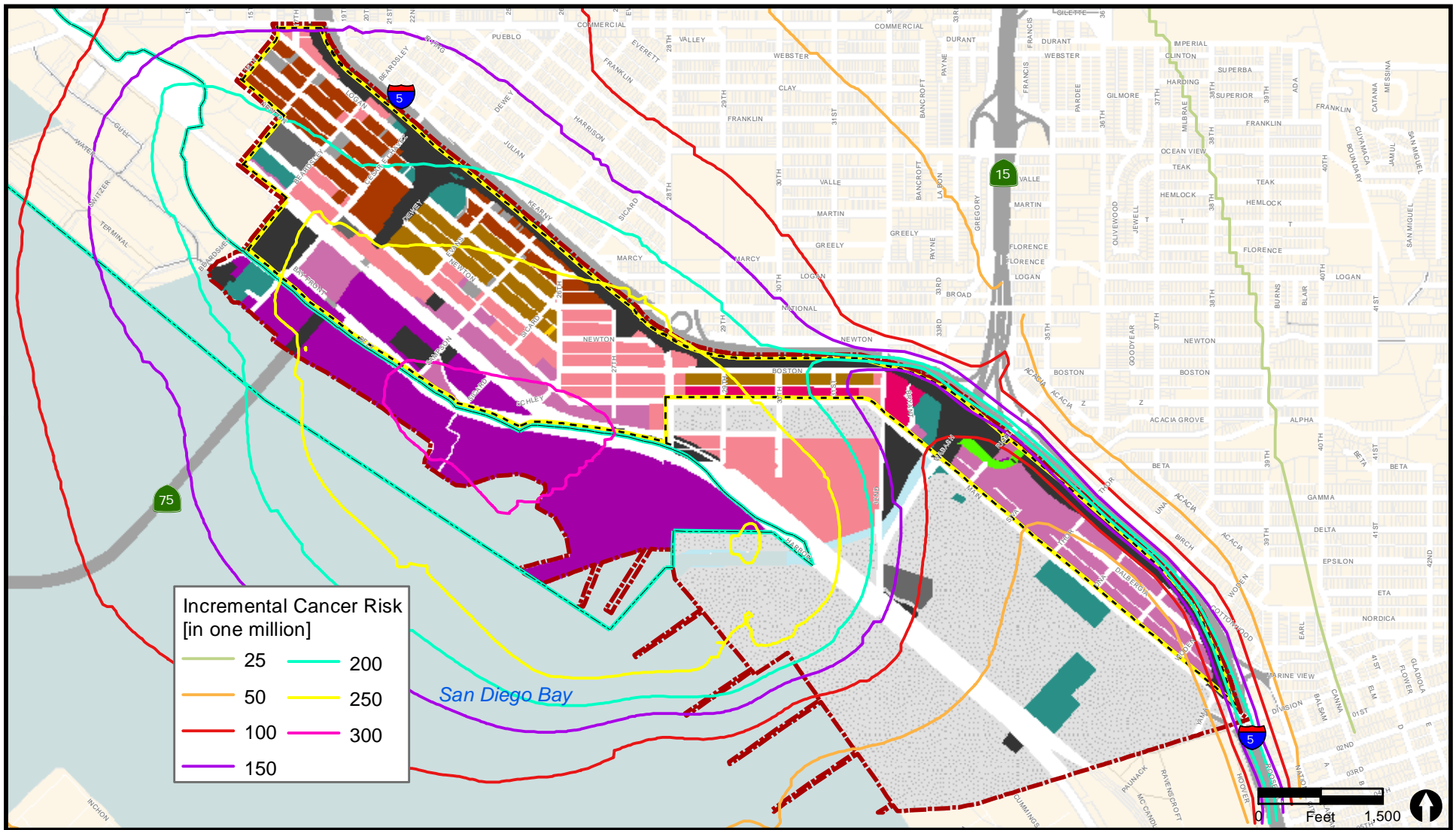

FIGURE 47

Total Estimated Diesel Particulate 80th Percentile Residential Incremental Cancer Risk Contours Overlain on the Adopted Community Plan Land Uses

ATTACHMENTS 2–15

available electronically upon request.

This page is intentionally blank.